

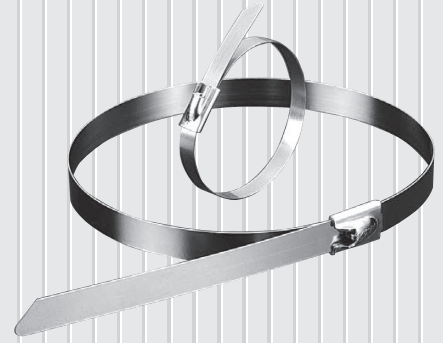

“maximum enerji maximum **TORQ**®”



TORQ®

2016

AĞUSTOS FİYAT LİSTESİ



“maximum enerji maximum **TORQ**®”



Saygı değer müşterilerimiz,

2010 yılında kurulan firmamız faaliyete başladığı ilk günden itibaren kalite ve ürün çeşitliliğini geliştirerek müşteri memnuniyeti odaklı hizmet vermeyi ilke edinmiştir.

Tork Elektroteknik çalışmalarını elektrik, otomotiv ve hırdavat endüstrisinde devam ettirmekte, hem yurt içi hem de yurt dışı pazarında seçkin firmalardan oluşan müşteri ağı ile sürdürmektedir.

Konusunda uzmanlaşan kadrosu ile ürün çeşitliliğini müşterilerin ihtiyaçları doğrultusunda kaliteli ve ekonomik olacak şekilde çözümler üretmeye devam edecektir.

Başarılı sonuçların gerçekleşmesinde desteklerinden ötürü pay sahibi olan hem müşterilerimize hemde çalışma arkadaşlarımıza teşekkür ederiz.

Saygılarımızla,

STANDART BEYAZ KABLO BAĞLARI Naylon 6.6

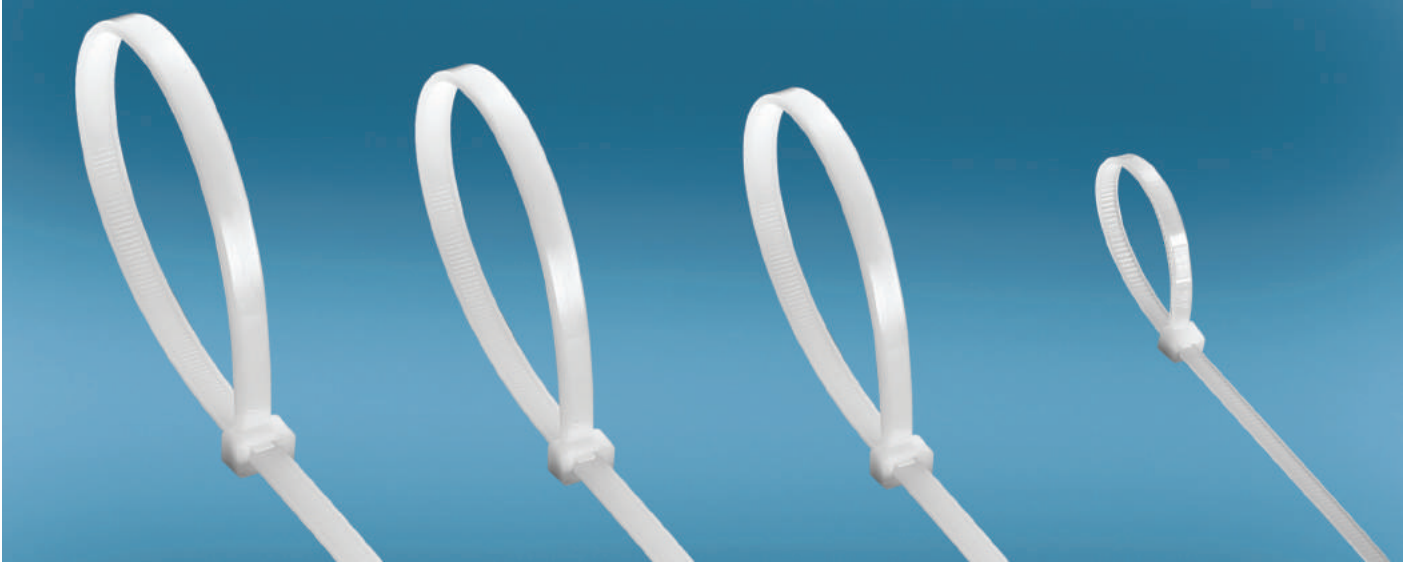

Ürün Kodu	Ebat		Renk	Maksimum Sıkma Çapı (mm)	Açılma Mukavemeti	Poşet Miktarı	Koli Miktarı	Adet Fiyatı (₺)
	En	Boy						
TKB-100M	2.5	100	Beyaz	25	8 kg	100	60 000	0.0100
TKB-150M		150	Beyaz	35		100	35 000	0.0173
TKB-200M		203	Beyaz	55		100	28 000	0.0257
TKB-140I	3.6	142	Beyaz	35	18 kg	100	25 000	0.0252
TKB-200I		203	Beyaz	55		100	22 000	0.0372
TKB-250I		250	Beyaz	68		100	15 000	0.0477
TKB-300I		292	Beyaz	85		100	15 000	0.0572
TKB-370I		368	Beyaz	102		100	12 000	0.0730
TKB-200S	4.8	203	Beyaz	55	22 kg	100	13 000	0.0483
TKB-250S		250	Beyaz	68		100	12 000	0.0682
TKB-300S		310	Beyaz	85		100	10 000	0.0787
TKB-370S		368	Beyaz	102		100	9 000	0.0955
TKB-430S		432	Beyaz	125		100	8 500	0.1260
TKB-300H	7.6	300	Beyaz	85	55 kg	100	5 000	0.1417
TKB-370H		368	Beyaz	102		100	4 500	0.1630
TKB-450H		450	Beyaz	133		100	3 500	0.2200
TKB-550H		550	Beyaz	166		100	3 500	0.3100
TKB-750H		750	Beyaz	223		100	1 500	0.4515
TKB-610L	9.0	610	Beyaz	185	80 kg	100	1 500	0.4730
TKB-710L		710	Beyaz	220		100	1 500	0.5500
TKB-760L		762	Beyaz	236		100	1 500	0.5500
TKB-920L		920	Beyaz	270		100	1 500	0.7870
TKB-1220L		1219	Beyaz	380		100	500	1.2600

STANDART SİYAH KABLO BAĞLARI Naylon 6.6



Ürün Kodu	Ebat		Renk	Maksimum Sıkma Çapı (mm)	Açılma Mukavemeti	Poşet Miktarı	Koli Miktarı	Adet Fiyatı (₺)
	En	Boy						
TKB-100M-B	2.5	100	Siyah	25	8 kg	100	60 000	0.0100
TKB-150M-B		150	Siyah	35		100	35 000	0.0173
TKB-200M-B		203	Siyah	55		100	28 000	0.0257
TKB-140I-B	3.6	142	Siyah	35	18 kg	100	25 000	0.0252
TKB-200I-B		203	Siyah	55		100	22 000	0.0372
TKB-250I-B		250	Siyah	68		100	15 000	0.0477
TKB-300I-B		292	Siyah	85		100	15 000	0.0572
TKB-370I-B		368	Siyah	102		100	12 000	0.0730
TKB-200S-B	4.8	203	Siyah	55	22 kg	100	13 000	0.0483
TKB-250S-B		250	Siyah	68		100	12 000	0.0682
TKB-300S-B		310	Siyah	85		100	10 000	0.0787
TKB-370S-B		368	Siyah	102		100	9 000	0.0955
TKB-430S-B		432	Siyah	125		100	8 500	0.1260
TKB-300H-B	7.6	300	Siyah	85	55 kg	100	5 000	0.1417
TKB-370H-B		368	Siyah	102		100	4 500	0.1630
TKB-450H-B		450	Siyah	133		100	3 500	0.2200
TKB-550H-B		550	Siyah	166		100	3 500	0.3100
TKB-750H-B		750	Siyah	223		100	1 500	0.4515
TKB-610L-B	9.0	610	Siyah	185	80 kg	100	1 500	0.4730
TKB-710L-B		710	Siyah	220		100	1 500	0.5500
TKB-760L-B		762	Siyah	236		100	1 500	0.5500
TKB-920L-B		920	Siyah	270		100	1 500	0.7870
TKB-1220L-B		1219	Siyah	380		100	500	1.2600

PASLANMAZ ÇELİK KABLO BAĞLARI



Ürün Kodu	Ebat		Malzeme	Mak. Sıkma Çapı (mm)	Açılma Mukavemeti	Poşet Miktarı	Koli Miktarı	Adet Fiyatı (₺)
	En	Boy						
TKBC-150S	4.6	150	304SS	44	55 kg	100	10.000	0.45
TKBC-200S		200	304SS	51		100	5.000	0.55
TKBC-300S		300	304SS	75		100	5.000	0.66
TKBC-370S		370	304SS	102		100	2.500	0.72
TKBC-520S		520	304SS	152		100	2.500	0.82

TKBC-300H	7.9	300	304SS	75	120 kg	100	4.000	0.85
TKBC-370H		370	304SS	102		100	2.000	0.92
TKBC-520H		520	304SS	152		100	1.000	1.20
TKBC-680H		680	304SS	203		100	1.000	1.40
TKBC-840H		840	304SS	224		100	1.000	1.80

PASLANMAZ ÇELİK KABLO BAĞLARI POLYESTER KAPLI



Ürün Kodu	Ebat		Malzeme	Mak. Sıkma Çapı (mm)	Açılma Mukavemeti	Poşet Miktarı	Koli Miktarı	Adet Fiyatı (₺)
	En	Boy						
TKBCP-200S	4.6	200	304SS	51	55 kg	100	5.000	0.72
TKBCP-300S		300	304SS	75		100	5.000	0.78
TKBCP-370S		370	304SS	102		100	2.500	0.88
TKBCP-520S		520	304SS	152		100	2.500	1.00

TKBCP-300H	7.9	300	304SS	75	120 kg	100	4.000	1.00
TKBCP-370H		370	304SS	102		100	2.000	1.10
TKBCP-520H		520	304SS	152		100	1.000	1.40
TKBCP-680H		680	304SS	203		100	1.000	1.78
TKBCP-840H		840	304SS	224		100	1.000	2.65

ETİKETLİ KABLO BAĞLARI Naylon 6.6



KOD	Ebat		Renk	Maksimum Sıkma Çapı (mm)	Açılma Mukavemeti	Poşet Miktarı	Koli Miktarı	Adet Fiyatı (₺)
	En	Boy						
TKBE-100M	2.5	100	Beyaz	25	8 kg	100	25 000	0.0450
TKBE-200S	4.8	200	Beyaz	55	22 kg	100	12 000	0.0900

PANELE KAFADAN SIKIŞAN KABLO BAĞLARI Naylon 6.6



KOD	Ebat		Renk	Maksimum Sıkma Çapı (mm)	Açılma Mukavemeti	Poşet Miktarı	Koli Miktarı	Adet Fiyatı (₺)
	En	Boy						
TKBD-100M	2.5	100	Beyaz	25	8	100	15 000	0.0430
TKBD-130S	4.8	130	Beyaz	35	18	100	5 000	0.0850
TKBD-200S	4.8	200	Beyaz	50	22	100	5 000	0.1200

METAL RULO KELEPÇE & BAĞLANTI KLİPSLERİ

METAL RULO KELEPÇE - AISI 430

Ebat		1 Rulo Bant	Koli Adedi	Adet Fiyatı (₺)
Kalınlık	Genişlik			
0.60 mm	9 mm	30 m	10	66.00
0.80 mm	12 mm	30 m	10	95.00



BAĞLANTI KLİPSİ

Kaplama	Band & Vida Malz.	Kutu Adedi	Koli Adedi	Adet Fiyatı (₺)
8 mikron krom	DIN 1623 - DIN 10263	50	500	1.30
8 mikron krom	DIN 1623 - DIN 10263	50	500	2.00

YAPIŞKANLI KROŞE

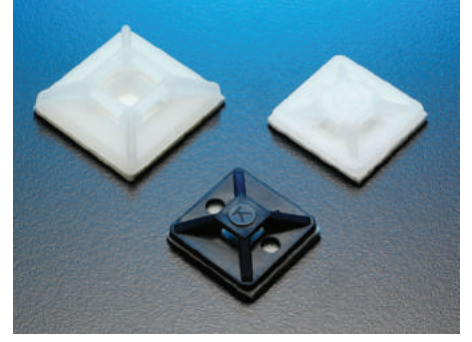

Ürün Kodu	Ebat		Renk	Kablo Bağı Girişi	Taşıma Mukavemeti	Poşet Miktarı	Koli Miktarı	Adet Fiyatı (₺)
	En	Boy						
TYK1919	19	19	Beyaz	4.5	10 kg	100	22 000	0.088
TYK1919-B	19	19	Siyah	4.5	10 kg	100	22 000	0.088
TYK2828	28	28	Beyaz	5.5	16 kg	100	10 000	0.130
TYK2828-B	28	28	Siyah	5.5	16 kg	100	10 000	0.130

VİDALI KROŞE

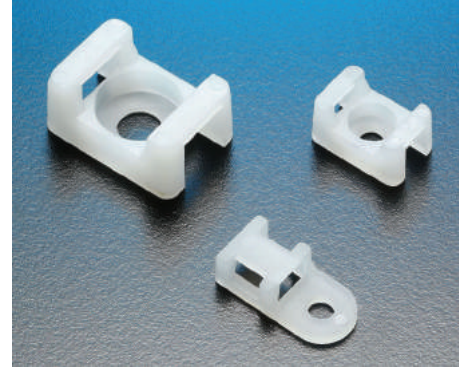

Ürün Kodu	Ebat		Renk	Kablo Bağı Girişi	Vida Deliği Çapı (mm)	Poşet Miktarı	Koli Miktarı	Adet Fiyatı (₺)
	En	Boy						
TVK1	10	15	Beyaz	5	3.5	100	30 000	0.050
TVK2	16	23	Beyaz	9	6	100	11 000	0.074

DÜBEL KROŞE

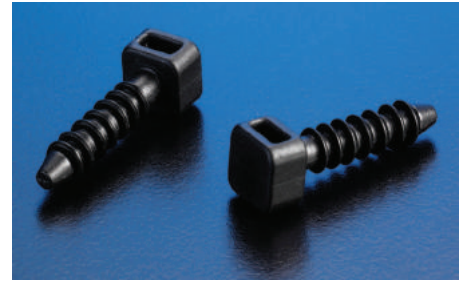

Ürün Kodu	Ebat		Renk	Kablo Bağı Girişi	Vida Deliği Çapı (mm)	Poşet Miktarı	Koli Miktarı	Adet Fiyatı (₺)
	En	Boy						
TDK8	9.7	43.8	Siyah	10	9	100	7 500	0.090

FLAT KABLO TUTUCU



Ürün Kodu	Ebat		Renk	Poşet Miktarı	Koli Miktarı	Adet Fiyatı (₺)
	En	Boy				
TYFC-15	15	24	Gri	100	12 000	0.170
TYFC-25	25	24	Gri	100	7 500	0.240

KABLO BAĞI ETİKET TAŞIYICI



Ürün Kodu	Ebat		Poşet Miktarı	Koli Miktarı	Adet Fiyatı (₺)
	En	Boy			
TKE-1	33	12	100	10.000	0.265
TKE-2	44	19	100	4.500	0.367

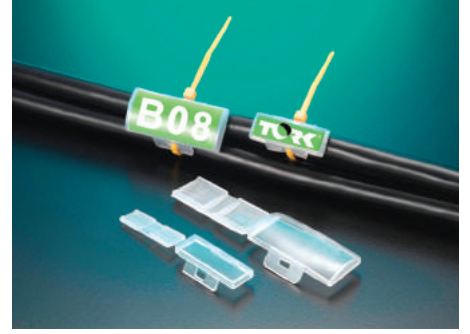

PANO ETİKETİ TAŞIYICI



Ürün Kodu	Ebat		Poşet Miktarı	Adet Fiyatı (₺)
	En	Boy		
TYPE-01	17	30	100	0.440
TYPE-02	17	52	100	0.520
TYPE-03	17	70	50	0.625



BASKILI DEVRE TAŞIYICILARI



Ürün Kodu	Ebat	Renk	Poşet Miktarı	Koli Miktarı	Adet Fiyatı (₺)
TBDT-6	6.4	Beyaz	100	40 000	0.080
TBDT-9	9.3	Beyaz	100	35 000	0.088
TBDT-13	12.7	Beyaz	100	30 000	0.099
TBDT-16	15.9	Beyaz	100	25 000	0.120
TBDT-19	19.1	Beyaz	100	25 000	0.150



BÜKÜLEBİLİR KLİPS



Ürün Kodu	Çap (mm)	Bağlama Çapı	Boy	Poşet Miktarı	Koli Miktarı	Adet Fiyatı (₺)
TBK05	5.10	4.4	21.6	100	70 000	0.050
TBK08	8.00	7.0	25.0	100	30 000	0.060
TBK11	11.60	10.1	29.8	100	40 000	0.070
TBK15	15.00	13.4	33.8	100	20 000	0.090
TBK18	18.60	16.2	40.0	100	18 000	0.110
TBK24	23.60	21.3	45.0	100	15 000	0.150

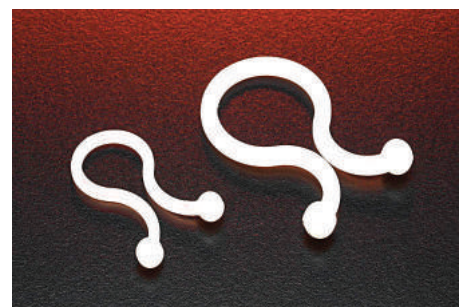

HELEZON SPİRALLER



Ürün Kodu	Ebat		Renk	Paket Miktarı	Koli Miktarı	Metre Fiyatı (₺)
	İç Çap	Dış Çap				
TSPR6 (No1)	4.1	6.2	Beyaz	10M	3,000M	0.360
TSPR8 (No2)	6.0	8.0		10M	1,800M	0.460
TSPR10 (No3)	7.5	10.0		10M	1,250M	0.750
TSPR12 (No4)	9.0	12.0		10M	900M	1.150
TSPR15 (No5)	12.0	15.0		10M	600M	1.570

KABLO TOPLAMA SPİRALLERİ



Ürün Kodu	Ebat	Renk	Paket Miktarı	Koli Miktarı	Metre Fiyatı (₺)
TTSPR8	8 mm	Siyah	5 m	750 m	2.100
TTSPR15	15 mm		5 m	350 m	2.800
TTSPR20	20 mm		5 m	275 m	4.300
TTSPR25	25 mm		5 m	150 m	6.800
TTSPR32	32 mm		5 m	90 m	10.500

PVC İZOLE BANTLAR



Siyah - Kırmızı - Beyaz - Gri - Yeşil - Mavi - Sarı-yeşil - Sarı

Ürün Kodu	Ebat	Koli Miktarı	Adet Fiyatı (USD)
TPVC-19	0,13 x 19 x 10 yds	500	0.29
TPVC-50	0,13 x 50 x 25 yds	80	1.90

ERİYEN BANTLAR



Ürün Kodu	Renk	Ebat	Koli Miktarı	Adet Fiyatı (USD)
TSFT-19	Siyah	19 x 0,8 x 8 m	60	1.70
TSFT-50	Siyah	50 x 0,8 x 8 m	24	4.80

PLASTİK KABLO KELEPÇELERİ



Ürün Kodu	Ebat (mm)	Vida Deliği Çapı (mm)	Boy (mm)	En (mm)	Poşet Miktarı	Koli Miktarı	Adet Fiyatı (₺)
TPKL3	3,0 (1/8")	4.6	17.0	9.6	100	40.000	0.0505
TPKL5	5,0 (3/16")		18.6	9.6	100	35.000	0.0525
TPKL6	6,35 (1/4")		20.0	10.0	100	27.000	0.0546
TPKL8	7,9 (5/16")		22.0	10.0	100	20.000	0.0693
TPKL10	9,5 (3/8")		24.0	12.0	100	12.000	0.0777
TPKL13	12,7 (1/2")		31.0	12.0	100	12.000	0.0840
TPKL16	15,8 (5/8")		34.3	12.0	100	8.000	0.0924
TPKL19	19,4 (3/4")		35.0	12.0	100	6.000	0.1100
TPKL25	25,4 (1")		43.0	12.0	100	4.500	0.1260
TPKL28	27,5 (1 1/16")		50.0	12.0	100	3.000	0.1500
TPKL32	31,8 (1 1/4")		46.2	12.0	100	3.000	0.1650
TPKL38	36,7 (1 1/2")		50.0	12.0	100	2.500	0.2000

YÜKSÜKLÜ BUAT KLEMENSİ (Kapama Parçası)



Ürün Kodu	Renk	Boy	Çap 1	Çap 2	Poşet Miktarı	Koli Miktarı	Adet Fiyatı (₺)
TKPM2	Beyaz	20.0	3.0	7.8	100	40,000	0.0600
TKPM5	Beyaz	25.3	3.8	10.5	100	18,000	0.0960

GEÇMELİ BUAT KLEMENSİ (Şeffaf)

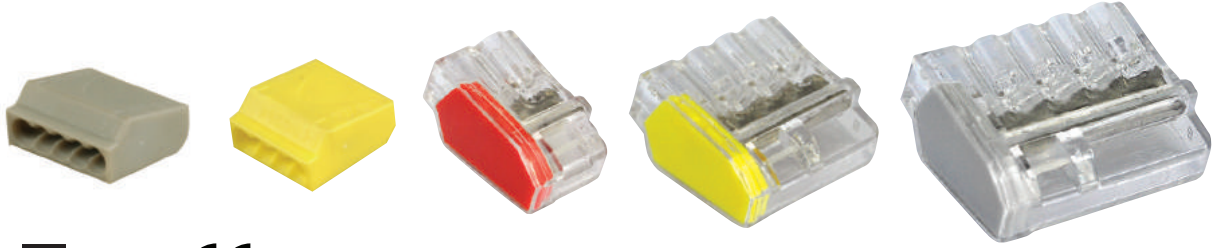

Ürün Kodu	Renk	Kablo Kesiti	Ebat		Ambalaj Miktarı	Adet Fiyatı (₺)
			En	Boy		
TGBKS-2	Kırmızı	2.5	10.5	19.5	500	0.25
TGBKS-3	Turuncu		13.5	19.7	500	0.33
TGBKS-4	Sarı		17.2	19.7	500	0.40
TGBKS-5	Gri		21.1	19.7	500	0.44
TGBKS-8	Siyah		17.5	19.0	250	1.00

VİDALI YAYLI BUAT KLEMENSİ



Ürün Kodu	Renk	Boy	Çap 1	Çap 2	Ambalaj Miktarı	Adet Fiyatı (₺)
TVBK-71	Gri	15	6.70	8.60	1.000	0.036
TVBK-72	Mavi	18	7.00	9.80	1.000	0.046
TVBK-73	Turuncu	22	9.90	12.20	500	0.060
TVBK-74	Sarı	24	11.20	14.00	500	0.077
TVBK-76	Kırmızı	27	13.00	16.40	500	0.130
TVBK-11K	Sarı	26	9.8	18.20	500	0.130
TVBK-12K	Kırmızı	32	13.5	23.00	500	0.170
TVBK-13K	Gri	33	14.9	25.50	250	0.230
TVBK-14K	Mavi	40	18.8	32.00	100	0.300

ÜSTTEN GEÇMELİ KABLO İŞARETLEME SİSTEMİ

Ürün Kodu	İşaret	Renk	Kablo Kesiti (mm)	Kutu Miktarı	Kutu Fiyatı (₺)
TMS-10	0	● Siyah	0.50-1.0	400	10.00
TMS-11	1	● Kahverengi			
TMS-12	2	● Kırmızı			
TMS-13	3	● Turuncu			
TMS-14	4	● Sarı			
TMS-15	5	● Yeşil			
TMS-16	6	● Mavi			
TMS-17	7	○ Mor			
TMS-18	8	○ Gri			
TMS-19	9	○ Beyaz			
TMS-1+	+	● Sarı			
TMS-1-	-	● Sarı			
TMS-1TPR	TPR	● Sarı			

TMS-20	0	● Siyah	1.5 - 2.5	400	11.00
TMS-21	1	● Kahverengi			
TMS-22	2	● Kırmızı			
TMS-23	3	● Turuncu			
TMS-24	4	● Sarı			
TMS-25	5	● Yeşil			
TMS-26	6	● Mavi			
TMS-27	7	● Mor			
TMS-28	8	○ Gri			
TMS-29	9	○ Beyaz			
TMS-2+	+	● Sarı			
TMS-2-	-	● Sarı			
TMS-2TPR	TPR	● Sarı			

TMS-30	0	● Siyah	4 - 6	400	12.00
TMS-31	1	● Kahverengi			
TMS-32	2	● Kırmızı			
TMS-33	3	● Turuncu			
TMS-34	4	● Sarı			
TMS-35	5	● Yeşil			
TMS-36	6	● Mavi			
TMS-37	7	● Mor			
TMS-38	8	○ Gri			
TMS-39	9	○ Beyaz			
TMS-3+	+	● Sarı			
TMS-3-	-	● Sarı			
TMS-3TPR	TPR	● Sarı			

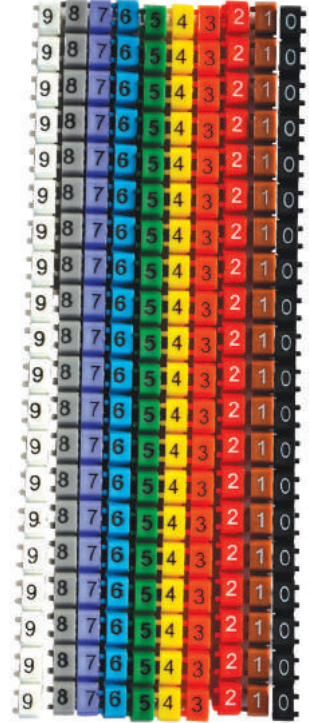

• Kablo işaretleme sistemlerinde tüm harfler mevcuttur.

BAŞTAN GEÇMELİ KABLO İŞARETLEME SİSTEMİ

Ürün Kodu	İşaret	Renk	Ebat	Makara Adedi	Makara Fiyatı (₺)
TEC-00	0	Sarı	0.5 - 1.0	1 000	11.00
TEC-01	1				
TEC-02	2				
TEC-03	3				
TEC-04	4				
TEC-05	5				
TEC-06	6				
TEC-07	7				
TEC-08	8				
TEC-09	9				
TEC-0+	+				
TEC-0-	-				
TEC-0TPR	TPR				

TEC-10	0	Sarı	1.5 - 2.5	1 000	11.00
TEC-11	1				
TEC-12	2				
TEC-13	3				
TEC-14	4				
TEC-15	5				
TEC-16	6				
TEC-17	7				
TEC-18	8				
TEC-19	9				
TEC-1+	+				
TEC-1-	-				
TEC-1TPR	TPR				

TEC-20	0	Sarı	4 - 6	500	11.00
TEC-21	1				
TEC-22	2				
TEC-23	3				
TEC-24	4				
TEC-25	5				
TEC-26	6				
TEC-27	7				
TEC-28	8				
TEC-29	9				
TEC-2+	+				
TEC-2-	-				
TEC-2TPR	TPR				

TEC-30	0	Sarı	10 - 25	250	11.00
TEC-31	1				
TEC-32	2				
TEC-33	3				
TEC-34	4				
TEC-35	5				
TEC-36	6				
TEC-37	7				
TEC-38	8				
TEC-39	9				
TEC-3+	+				
TEC-3-	-				
TEC-3TPR	TPR				

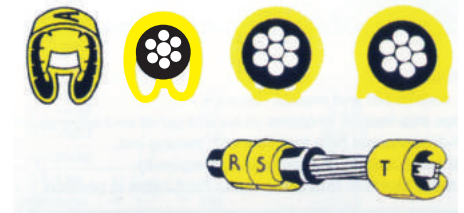

G*APEX G5 SERİSİ DARALAN MAKARONLAR

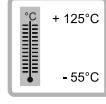
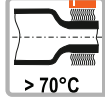
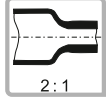

Ürün Kodu	Ölçü	Daralmadan Önce		Daralmadan Sonra		Makara (m)	Koli (m)	Metre Fiyatı (USD)
		İç Çap	Cidar Kalınlığı	İç Çap	Cidar Kalınlığı			
G5-1.0	1.0	1.5 ± 0.3	0.15 ± 0.05	0.60	0.33	200	3200	0.054
G5-1.5	1.5	2.0 ± 0.3	0.20 ± 0.05	0.75	0.36	200	2400	0.056
G5-2.0	2.0	2.5 ± 0.3	0.20 ± 0.05	1.00	0.44	200	3000	0.063
G5-2.5	2.5	3.0 ± 0.3	0.20 ± 0.05	1.25	0.44	200	2600	0.070
G5-3.0	3.0	3.5 ± 0.3	0.25 ± 0.05	1.50	0.44	200	2200	0.081
G5-3.5	3.5	4.0 ± 0.3	0.25 ± 0.05	1.75	0.44	200	1800	0.084
G5-4.0	4.0	4.5 ± 0.3	0.25 ± 0.05	2.00	0.44	200	1400	0.093
G5-4.5	4.5	5.0 ± 0.3	0.25 ± 0.05	2.25	0.44	100	1000	0.102
G5-5.0	5.0	5.5 ± 0.3	0.25 ± 0.05	2.50	0.56	100	900	0.112
G5-6.0	6.0	6.5 ± 0.3	0.25 ± 0.05	3.00	0.56	100	700	0.123
G5-7.0	7.0	7.6 ± 0.3	0.28 ± 0.05	3.50	0.56	100	1400	0.133
G5-8.0	8.0	8.6 ± 0.3	0.30 ± 0.06	4.00	0.56	100	1300	0.147
G5-9.0	9.0	9.6 ± 0.3	0.30 ± 0.06	4.50	0.56	100	1200	0.154
G5-10.0	10.0	10.7 ± 0.4	0.30 ± 0.06	5.00	0.56	100	1100	0.161
G5-11.0	11.0	11.7 ± 0.4	0.30 ± 0.06	5.50	0.56	100	1100	0.175
G5-12.0	12.0	12.7 ± 0.4	0.30 ± 0.06	6.00	0.56	100	1000	0.203
G5-13.0	13.0	13.7 ± 0.4	0.30 ± 0.06	6.50	0.69	100	900	0.220
G5-14.0	14.0	14.7 ± 0.4	0.35 ± 0.07	7.00	0.69	100	900	0.260
G5-15.0	15.0	15.7 ± 0.5	0.35 ± 0.07	7.50	0.69	100	800	0.336
G5-16.0	16.0	16.7 ± 0.5	0.35 ± 0.07	8.00	0.69	100	800	0.378
G5-17.0	17.0	17.5 ± 0.6	0.35 ± 0.07	8.50	0.70	100	700	0.434
G5-18.0	18.0	19.0 ± 0.5	0.35 ± 0.07	9.00	0.77	100	700	0.476
G5-20.0	20.0	21.0 ± 0.5	0.40 ± 0.10	10.00	0.77	100	600	0.560
G5-22.0	22.0	23.0 ± 0.5	0.40 ± 0.10	11.00	0.77	100	600	0.630
G5-25.0	25.0	26.0 ± 1.0	0.45 ± 0.10	12.50	0.87	50	300	0.686
G5-28.0	28.0	29.0 ± 1.0	0.45 ± 0.10	14.00	0.87	50	250	1.120
G5-30.0	30.0	31.5 ± 0.7	0.45 ± 0.10	15.00	0.95	50	250	1.190
G5-35.0	35.0	37.0 ± 0.7	0.50 ± 0.15	17.50	1.00	50	200	1.570
G5-40.0	40.0	40.5 ± 0.7	0.50 ± 0.15	20.00	1.00	50	200	1.610
G5-50.0	50.0	50.5 ± 0.7	0.50 ± 0.15	25.00	1.00	25	125	2.800

G*APEX G1 SERİSİ ŞEFFAF DARALAN MAKARONLAR

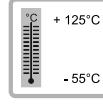
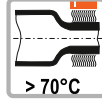
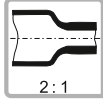
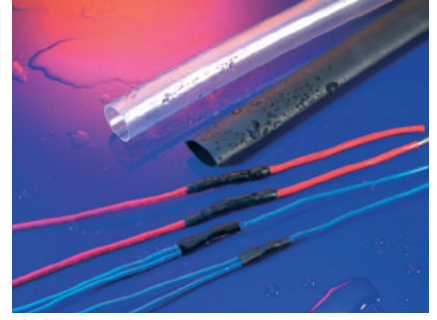

Ürün Kodu	Ölçü	Daralmadan Önce		Daralmadan Sonra		Makara (m)	Koli (m)	Metre Fiyatı (USD)
		İç Çap	Cidar Kalınlığı	İç Çap	Cidar Kalınlığı			
G1-1,5	1.5	2.0 ± 0.3	0.20 ± 0.05	0.75	0.36	200	2400	0.070
G1-2,5	2.5	3.0 ± 0.3	0.20 ± 0.05	1.25	0.44	200	2600	0.082
G1-3,5	3.5	4.0 ± 0.3	0.25 ± 0.05	1.75	0.44	200	1800	0.108
G1-5,0	5.0	5.5 ± 0.3	0.25 ± 0.05	2.50	0.56	100	900	0.140
G1-6,0	6.0	6.5 ± 0.3	0.28 ± 0.05	3.00	0.56	100	700	0.170
G1-9,0	9.0	9.6 ± 0.3	0.30 ± 0.06	4.50	0.56	100	1200	0.225
G1-12,0	12.0	12.7 ± 0.4	0.30 ± 0.06	6.00	0.56	100	1000	0.280
G1-16,0	16.0	16.7 ± 0.5	0.35 ± 0.07	8.00	0.69	100	800	0.535
G1-20,0	20.0	21.0 ± 0.5	0.40 ± 0.10	10.00	0.77	100	600	0.770
G1-25,0	25.0	26.0 ± 1.0	0.45 ± 0.10	12.50	0.87	50	300	1.120
G1-30	30.0	31.5 ± 0.7	0.45 ± 0.10	15.00	0.95	50	250	1.540
G1-40	40.0	4.05 ± 0.7	0.50 ± 0.15	20.00	1.00	50	200	2.380
G1-50	50.0	50.5 ± 0.7	0.50 ± 0.15	25.00	1.00	25	125	2.660

G*APEX İÇİ YAPIŞKANLI DARALAN MAKARONLAR

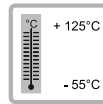
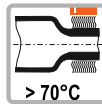
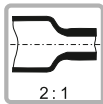

Ürün Kodu	Ölçü	Daralmadan Önce	Daralmadan Sonra		Makara (m)	Koli (m)	Metre Fiyatı (USD)
		İç Çap	İç Çap	Cidar Kalınlığı			
AIS-5	4.8	4.8	1.6	1.0	1.22	1200	0.84
AIS-6	6.4	6.4	2.0	1.0	1.22	1000	1.12
AIS-10	9.5	9.5	3.0	1.4	1.22	500	1.40
AIS-13	12.7	12.7	4.0	1.8	1.22	300	2.52
AIS-19	19.1	19.1	5.0	2.2	1.22	150	4.20
ATM-22	22.0	22	6.0	2.5	1.22	150	4.76
ATM-28	28.0	28	6.0	2.5	1.22	110	4.90
ATM-33	33.0	33	8.0	2.5	1.22	100	5.32
ATM-40	40.0	40	12.0	2.5	1.22	90	6.72
ATM-55	55.0	55	14.0	2.7	1.22	60	9.80
ATM-65	65.0	65	16.0	2.8	1.22	40	12.60
ATM-75	75.0	75	19.0	3.0	1.22	32	15.40
ATM-95	95.0	95	25.0	3.0	1.22	24	16.80
ATM-115	115.0	115	34.0	3.0	1.22	20	21.00
ATM-140	140.0	140	42.0	3.0	1.22	20	42.00

G*APEX KABLO TOPLAMA ÇORAPLARI

Ürün Kodu	Ölçü (mm)	Makara (m)	Koli (m)	Metre Fiyatı (USD)
BSPET-3	3.2	305	3050	0.215
BSPET-6	6.4	305	3050	0.270
BSPET-9	9.5	153	918	0.435
BSPET-12	12.7	153	918	0.500
BSPET-15	15.0	153	918	0.530
BSPET-19	19.1	77	462	0.780
BSPET-25	25.0	77	462	1.000
BSPET-32	31.7	77	462	1.300
BSPET-38	38.1	61	366	1.780
BSPET-44	44.5	61	366	2.200
BSPET-50	50.0	61	366	2.200



MAKARON ISITMA TABANCASI



Ürün Kodu	Açıklama	Fiyatı
TMALT-HL-1610S	1600 W	75.00 EURO
TMALT-CAT-202	300 - 525 °C	50.00 USD

maximum enerji maximum

TORK®



STANDART TİP (SKP) SIKMALI KABLO PABUÇLARI



Elektrolitik Bakır 99.9
İletkenlik Katsayısı min. 56 ms/m

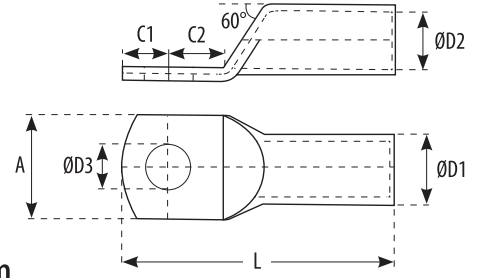

Ürün Kodu	Kablo Kesiti	Civata	ØD3	ØD2	ØD1	L	A	C1	C2	Kutu Adedi	Adet Fiyatı (₺)
TSKP-10-05	10 mm ²	M5	5.2	4.7	6.5	27.5	10.5	5.5	6.5	800	0.315
TSKP-10-06		M6	6.5	4.7	6.5	27.5	10.5	5.5	6.5		0.336
TSKP-16-06	16 mm ²	M6	6.5	5.8	7.4	30	12	5.5	6.5	500	0.465
TSKP-16-08		M8	8.5	5.8	7.8	30	12	5.8	6.5		0.505
TSKP-25-08	25 mm ²	M8	8.5	7.0	9.2	40	14	7	9	350	0.735
TSKP-25-10		M10	10.5	7.0	9.5	40	14	7	9		0.840
TSKP-35-08	35 mm ²	M8	8.5	8.2	11.0	44	15.3	8.5	9.5	200	1.000
TSKP-35-10		M10	10.5	8.2	11.0	44	15.3	8.5	9.5		1.103
TSKP-50-08	50 mm ²	M8	8.5	10.2	13.0	52	20	10	11.5	150	1.733
TSKP-50-10		M10	10.5	10.2	13.0	52	20	10	11.5		1.575
TSKP-50-12		M12	13	10.2	13.0	52	20	10	11.5		1.733
TSKP-70-08	70 mm ²	M8	8.5	11.7	14.7	55	22	10	11.5	100	2.415
TSKP-70-10		M10	10.5	11.7	14.7	55	22	10	11.5		2.205
TSKP-70-12		M12	13	11.7	14.7	55	22	10	11.5		2.415
TSKP-95-08	95 mm ²	M8	8.5	13.5	16.7	59	26	10	12	80	2.940
TSKP-95-10		M10	10.5	13.5	16.7	59	26	10	12		2.940
TSKP-95-12		M12	13	13.5	16.7	59	26	10	12		2.730
TSKP-120-10	120 mm ²	M10	10.5	15.5	19.0	70	29	13	14	50	4.200
TSKP-120-12		M12	13	15.5	19.0	70	29	13	14		4.000
TSKP-120-14		M14	15	15.5	19.0	70	29	13	14		4.200
TSKP-150-10	150 mm ²	M10	10.5	16.7	21.0	77	32	17	14	40	6.825
TSKP-150-12		M12	13	16.7	21.0	77	32	17	14		6.300
TSKP-150-14		M14	15	16.7	21.0	77	32	17	14		6.825
TSKP-185-12	185 mm ²	M12	13	18.8	23.0	85	35	17	18	30	8.085
TSKP-185-14		M14	15	18.8	23.0	85	35	17	18		8.085
TSKP-185-16		M16	17	18.8	23.0	85	35	17	18		7.770
TSKP-240-12	240 mm ²	M12	13	21.2	26.0	90	38.5	17	18	25	11.025
TSKP-240-14		M14	15	21.2	26.0	90	38.5	17	18		11.025
TSKP-240-16		M16	17	21.2	26.0	90	38.5	17	18		9.975
TSKP-300-12	300 mm ²	M12	13	23.5	28.6	100	43	18	18	20	14.175
TSKP-300-14		M14	15	23.5	28.6	100	43	18	18		14.175
TSKP-300-16		M16	17	23.5	28.6	100	43	18	18		13.125

*Gri renk ile belirtilen kablo pabuçları standart stoklarımızdır. Diğer ölçüler için stok sorunuz.

EKONOMİK TİP (SKP) SIKMALI KABLO PABUÇLARI



Elektrolitik Bakır 99.9
İletkenlik Katsayısı min. 56 ms/m

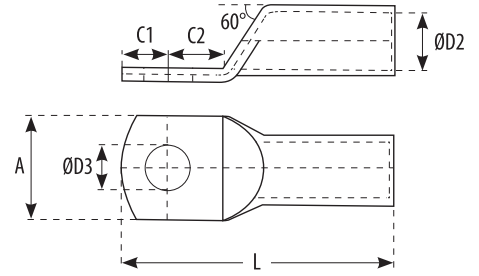

Ürün Kodu	Kablo Kesiti	Civata	ØD3	ØD2	L	A	C1	C2	Kutu Adedi	Adet Fiyatı (₺)
TSKPE-10-05	10 mm ²	M5	5.2	5	27.5	10.5	5.5	6.5	800	0.235
TSKPE-16-06	16 mm ²	M6	6.5	5.8	30	12	5.5	6.5	500	0.305
TSKPE-25-08	25 mm ²	M8	8.5	7.2	40	14	7	9	350	0.525
TSKPE-35-08	35 mm ²	M8	8.5	8.5	44	15.3	8.5	9.5	200	0.735
TSKPE-50-10	50 mm ²	M10	10.5	10	52	20	10	11.5	150	1.000
TSKPE-70-10	70 mm ²	M10	10.5	11.5	55	22	10	11.5	100	1.575
TSKPE-95-12	95 mm ²	M12	13	13.5	59	26	10	12	80	1.890
TSKPE-120-12	120 mm ²	M12	13	15.6	70	29	13	14	50	2.625
TSKPE-150-12	150 mm ²	M12	13	17	77	32	17	17	40	4.515
TSKPE-185-16	185 mm ²	M16	17	19	85	35	17	18	30	5.250
TSKPE-240-16	240 mm ²	M16	17	21	90	38.5	17	18	25	7.665
TSKPE-300-16	300 mm ²	M16	17	23.5	100	43	18	18	20	10.500

BİMETALİK SIKMALI KABLO PABUÇLARI (Bakır Alüminyumlu)

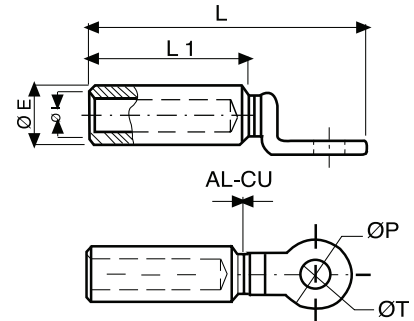

Ürün Kodu	Kablo Kesiti mm ²	Civata	Ø E	Ø I	L	Ø T	L1	Ağırlık	Kutu Adedi	Adet Fiyatı (₺)
TSKPBM-1610	16	M10	20	6,5	84	12,8	46	7,2	480	6.00
TSKPBM-2510	25	M10	20	6,5	84	12,8	46	7,2	480	6.50
TSKPBM-3510	35	M10	20	8	84	12,8	46	7,2	480	7.00
TSKPBM-5010	50	M10	20	9	84	12,8	46	7	320	8.00
TSKPBM-7012	70	M12	20	11	84	12,8	46	7	320	8.50
TSKPBM-9512	95	M12	20	12,5	84	12,8	46	6,3	320	9.00
TSKPBM-12012	120	M12	25	13,7	107	12,8	62,5	13,5	160	13.50
TSKPBM-15012	150	M12	25	15,5	107	12,8	62,5	12,2	160	14.00
TSKPBM-18512	185	M12	32	17	117	14,5	64	20,1	100	24.00
TSKPBM-24012	240	M12	32	19,5	117	14,5	64	22,6	100	26.00
TSKPBM-30016	300	M16	36	23,3	157	16,3	90	33,4	64	34.00
TSKPBM-40016	400	M16	36	26	157	16,3	90	30,2	64	42.00
TSKPBM-50016	400	M16	36	26	157	16,3	90	30,2	36	88.00
TSKPBM-63016	400	M16	36	26	157	16,3	90	30,2	24	120.00

ALÜMİNYUM SIKMALI KABLO PABUÇLARI

KOD	KESİT	DELİK ÇAPI	İÇ ÇAP	DIŞ ÇAP	UZUNLUK	KUTU AD.	FİYAT ₺
TSKPAL-16	16	6	5,60	10	60	200	0.83
TSKPAL-25	25	8	7,00	12	70	150	0.99
TSKPAL-35	35	8	8,20	14	76	100	1.20
TSKPAL-50	50	10	10,00	16	83	75	1.75
TSKPAL-70	70	12	11,40	18	97	50	2.00
TSKPAL-95	95	12	13,40	22	109	50	3.00
TSKPAL-120	120	12	15,00	22	109	40	3.50
TSKPAL-150	150	12	16,50	26	118,5	25	4.00
TSKPAL-185	185	12	18,50	28	125,5	20	6.00
TSKPAL-240	240	12	21,20	32	141,5	20	8.00
TSKPAL-300	300	16	24,50	34	143	10	11.50



AL-CU TİP SIKMALI KABLO PABUÇLARI (Bakır Alüminyumlu)

KOD	KESİT	DELİK ÇAPI	İÇ ÇAP	DIŞ ÇAP	UZUNLUK	KUTU AD.	FİYAT ₺
TSKPALCU-16	16	6	5,60	10	60	200	2.35
TSKPALCU-25	25	8	7,00	12	70	150	2.70
TSKPALCU-35	35	8	8,20	14	76	100	3.40
TSKPALCU-50	50	10	10,00	16	83	75	4.15
TSKPALCU-70	70	12	11,40	18	97	50	5.55
TSKPALCU-95	95	12	13,40	22	109	50	6.60
TSKPALCU-120	120	12	15,00	22	109	40	7.60
TSKPALCU-150	150	12	16,50	26	118,5	25	8.80
TSKPALCU-185	185	12	18,50	28	125,5	20	9.90
TSKPALCU-240	240	12	21,20	32	141,5	20	13.80
TSKPALCU-300	300	16	24,50	34	143	10	15.80



BİMETAL KABLO PABUÇLARI İÇİN BAĞLANTI ELEMANI

KOD	KUTU AD.	AÇIKLAMA	BİRİM FİYAT
TSKPBM-Z	100	Bağlantı Aparatı	4.00



BAKIR EK MUFLAR

KOD	KESİT mm ²	KUTU AD.	FİYAT ₺
TMUFS-10	10	600	0.40
TMUFS-16	16	400	0.55
TMUFS-25	25	250	0.90
TMUFS-35	35	150	1.20
TMUFS-50	50	90	1.70
TMUFS-70	70	65	2.50
TMUFS-95	95	50	3.15
TMUFS-120	120	40	4.10
TMUFS-150	150	25	6.10
TMUFS-185	185	22	7.35
TMUFS-240	240	18	11.50



ALÜMİNYUM EK MUFLAR

KOD	KESİT mm ²	KUTU AD.	FİYAT ₺
TMUFA-16	16	200	0.83
TMUFA-25	25	125	0.99
TMUFA-35	35	100	1.20
TMUFA-50	50	75	1.75
TMUFA-70	70	50	2.25
TMUFA-95	95	40	3.00
TMUFA-120	120	25	3.50
TMUFA-150	150	20	5.00
TMUFA-185	185	15	6.90
TMUFA-240	240	15	8.80



U TİPİ KLEMENSLER

KOD	CİNSİ	KUTU AD.	FİYAT ₺
TU-6	6'lik U Klemens	150	1.25
TU-10	10'luk U Klemens	125	1.80
TU-16	16'lik U Klemens	100	2.30
TU-25	25'lik U Klemens	100	3.00
TU-35	35'lik U Klemens	75	3.50
TU-50	50'lik U Klemens	50	5.00
TU-70	70'lik U Klemens	40	6.00
TU-95	95'lik U Klemens	25	10.00
TU-120	120'lik U Klemens	20	11.50
TU-150	150'lik U Klemens	15	17.00

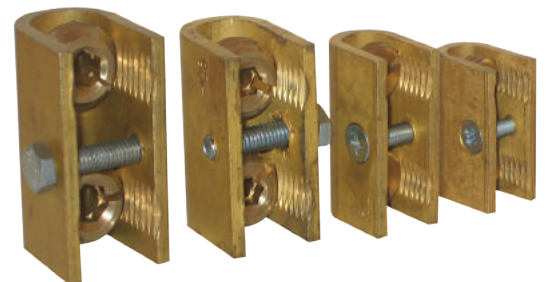

İZOLELİ KABLO YÜKSÜKLERİ

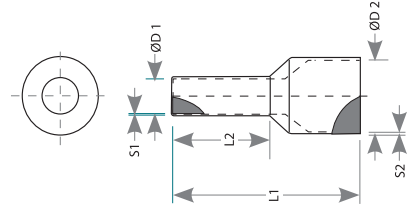

FRANSIZ NORMU DIN 46228

Ürün Kodu	Kablo Kesiti (mm)	Renk	D1	D2	L1	L2	Ambalaj Miktarı	Adet Fiyatı (₺)
TYIF-0,34-8	0.34	Pembe	0.80	1.90	12.00	8.00	2 000	0.0320
TYIF-0,50-8	0.50	Beyaz	1.00	2.60	14.00	8.00	1 000	0.0176
TYIF-0,75-8	0.75	Mavi	1.20	2.80	14.00	8.00	1 000	0.0176
TYIF-1,0-8	1.00	Kırmızı	1.40	3.00	14.00	8.00	1 000	0.0187
TYIF-1,5-8	1.50	Siyah	1.70	3.50	14.00	8.00	500	0.0210
TYIF-1,5-12	1.50	Siyah	1.70	3.50	18.00	12.00	500	-----
TYIF-2,5-8	2.50	Gri	2.20	4.20	14.00	8.00	500	0.0250
TYIF-2,5-12	2.50	Gri	2.20	4.20	18.00	12.00	500	-----
TYIF-4,0-10	4.00	Turuncu	2.80	4.80	17.00	10.00	500	0.0410
TYIF-6,0-12	6.00	Yeşil	3.50	6.30	20.00	12.00	250	0.0540
TYIF-10-12	10.00	Kahverengi	4.50	7.60	22.00	12.00	100	0.0730
TYIF-16-12	16.00	Fildişi	5.80	8.80	24.00	12.00	100	0.1100
TYIF-25-16	25.00	Siyah	7.30	11.20	30.00	16.00	50	0.2100
TYIF-35-16	35.00	Kırmızı	8.30	12.70	30.00	16.00	50	0.2800
TYIF-50-20	50.00	Mavi	10.20	15.00	36.00	20.00	25	0.4500
TYIF-70-21	70.00	Sarı	13.50	16.00	37.00	21.00	25	0.9000

ALMAN NORMU DIN 46228

Ürün Kodu	Kablo Kesiti (mm)	Renk	D1	D2	L1	L2	Ambalaj Miktarı	Adet Fiyatı (₺)
TYIA-0,34-8	0.34	Mavi	0.80	1.90	12.00	8.00	2 000	0.0320
TYIA-0,50-8	0.50	Turuncu	1.00	2.60	14.00	8.00	1 000	0.0176
TYIA-0,75-8	0.75	Beyaz	1.20	2.80	14.00	8.00	1 000	0.0176
TYIA-1,0-8	1.00	Sarı	1.40	3.00	14.00	8.00	1 000	0.0187
TYIA-1,5-8	1.50	Kırmızı	1.70	3.50	14.00	8.00	500	0.0210
TYIA-1,5-12	1.50	Kırmızı	1.70	3.50	18.00	12.00	500	-----
TYIA-2,5-8	2.50	Mavi	2.20	4.20	14.00	8.00	500	0.0250
TYIA-2,5-12	2.50	Mavi	2.20	4.20	18.00	12.00	500	-----
TYIA-4,0-10	4.00	Gri	2.80	4.80	17.00	10.00	500	0.0410
TYIA-6,0-12	6.00	Siyah	3.50	6.30	20.00	12.00	250	0.0540
TYIA-10-12	10.00	Fildişi	4.50	7.60	22.00	12.00	100	0.0730
TYIA-16-12	16.00	Yeşil	5.80	8.80	24.00	12.00	100	0.1100
TYIA-25-16	25.00	Kahverengi	7.30	11.20	30.00	16.00	50	0.2100
TYIA-35-16	35.00	Fildişi	8.30	12.70	30.00	16.00	50	0.2800
TYIA-50-20	50.00	Yeşil	10.20	15.00	36.00	20.00	25	0.4500

İZOLELİ ÇİFT GİRİŞLİ KABLO YÜKSÜKLERİ

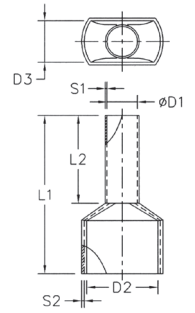

FRANSIZ NORMU DIN 46228

Ürün Kodu	Kablo Kesiti (mm)	Renk	D1	W	W1	L1	L2	Ambalaj Miktarı	Adet Fiyatı (₺)
TYÇF-0,50	2 x 0,50	○ Beyaz	1.50	2.70	4.70	15.00	8.00	1.000	0.0385
TYÇF-0,75	2 x 0,75	● Mavi	1.80	2.80	5.00	15.00	8.00	500	0.0385
TYÇF-1,0	2 x 1,00	● Kırmızı	2.05	3.40	5.40	15.00	8.00	500	0.0402
TYÇF-1,5	2 x 1,50	● Siyah	2.30	3.60	6.60	16.00	8.00	500	0.0462
TYÇF-2,5	2 x 2,50	○ Gri	2.80	4.20	7.80	18.50	10.00	250	0.0495
TYÇF-4,0	2 x 4,00	● Turuncu	3.70	4.90	8.80	23.00	12.00	200	0.1115
TYÇF-6,0	2 x 6,00	● Yeşil	4.80	6.90	10.00	26.00	14.00	100	0.1650
TYÇF-10	2 x 10,00	● Kahverengi	6.40	7.60	12.80	26.50	14.00	100	0.2310
TYÇF-16	2 x 16,00	○ Fildişi	8.30	9.60	18.60	31.50	14.00	50	0.4180

ALMAN NORMU DIN 46228

Ürün Kodu	Kablo Kesiti (mm)	Renk	D1	W	W1	L1	L2	Ambalaj Miktarı	Adet Fiyatı (₺)
TYÇA-0,50	2 x 0,50	● Turuncu	1.50	2.70	4.70	15.00	8.00	1.000	0.0385
TYÇA-0,75	2 x 0,75	○ Beyaz	1.80	2.80	5.00	15.00	8.00	500	0.0385
TYÇA-1,0	2 x 1,00	● Sarı	2.05	3.40	5.40	15.00	8.00	500	0.0402
TYÇA-1,5	2 x 1,50	● Kırmızı	2.30	3.60	6.60	16.00	8.00	500	0.0462
TYÇA-2,5	2 x 2,50	● Mavi	2.80	4.20	7.80	18.50	10.00	250	0.0495
TYÇA-4,0	2 x 4,00	○ Gri	3.70	4.90	8.80	23.00	12.00	200	0.1115
TYÇA-6,0	2 x 6,00	● Siyah	4.80	6.90	10.00	26.00	14.00	100	0.1650
TYÇA-10	2 x 10,00	○ Fildişi	6.40	7.60	12.80	26.50	14.00	100	0.2310
TYÇA-16	2 x 16,00	● Yeşil	8.30	9.60	18.60	31.50	14.00	50	0.4180

İZOLESİZ KABLO YÜKSÜKLERİ DIN 46228

Ürün Kodu	Kablo Kesiti (mm)	D1	D2	L	Ambalaj Miktarı	Adet Fiyatı (₺)
TY-0, 50-10	0.50	1.00	2.10	10.00	1.000	0.0168
TY-0, 75-10	0.75	1.20	2.30	10.00	1.000	0.0168
TY-1, 0-10	1.00	1.40	2.50	10.00	1.000	0.0168
TY-1, 5-10	1.50	1.70	2.80	10.00	1.000	0.0182
TY-2, 5-12	2.50	2.20	3.40	12.00	1.000	0.0238
TY-4, 0-12	4.00	2.80	4.00	12.00	1.000	0.0350
TY-6, 0-12	6.00	3.50	4.70	12.00	500	0.0378
TY-10-15	10.00	4.50	5.80	15.00	200	0.0630
TY-16-15	16.00	5.80	7.50	15.00	100	0.0700
TY-25-16	25.00	7.30	9.50	16.00	100	0.1232
TY-35-16	35.00	8.30	11.00	16.00	75	0.1820
TY-50-20	50.00	10.30	13.00	20.00	25	0.3500

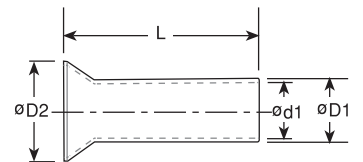

YUVARLAK TİP İZOLELİ KABLO UÇLARI

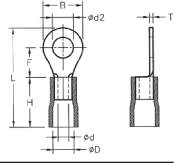

Ürün Kodu	Kablo Kesiti (mm ²)	Civata Ölçüsü	d2	B	F	L	H	d	D	T	Ambalaj Miktarı	Adet Fiyatı (₺)
TPY-301	0,50 - 1,50	M3	3.2	5.5	4.8	17.5	10.0	1.7	4.2	0.8	200	0.0572
TPY-351		M3,5	3.7	6.6	6.3	19.6					200	0.0605
TPY-401		M4	4.3	8.0	7.0	21.0					200	0.0770
TPY-501		M5	5.3	8.0	7.0	21.0					200	0.0825
TPY-601		M6	6.4	11.6	11.1	26.9					200	0.1000
TPY-801		M8	8.4	11.6	11.1	26.9					200	0.1100
TPY-302	1,50 - 2,50	M3	3.2	6.6	4.3	17.6	10.0	2.3	4.6	0.8	200	0.0815
TPY-352		M3,5	3.7	6.6	6.3	19.6					200	0.0880
TPY-402		M4	4.3	6.6	6.3	19.6					200	0.0880
TPY-502		M5	5.3	8.5	7.8	22.0					200	0.1000
TPY-602		M6	6.4	12.0	11.0	27.0					200	0.1100
TPY-802		M8	8.4	12.0	11.0	27.0					200	0.1200
TPY-1002	M10	10.5	13.6	13.9	30.7	200	0.1400					
TPY-406	4,00 - 6,00	M4	4.3	7.2	5.9	22.5	13.0	3.4	6.5	1.0	100	0.1550
TPY-506		M5	5.3	9.5	8.3	26.0					100	0.1650
TPY-606		M6	6.4	12.0	10.5	29.5					100	0.1850
TPY-806		M8	8.4	15.0	13.7	34.2					100	0.2400
TPY-1006		M10	10.5	15.0	13.7	34.2					100	0.2550
TPY-1206		M12	13.0	19.2	16.0	38.6					100	0.2900

İĞNE TİPİ İZOLELİ KABLO UÇLARI

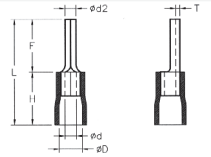

Ürün Kodu	Kablo Kesiti (mm ²)	Civata Ölçüsü	d2	B	F	L	H	d	D	T	Ambalaj Miktarı	Adet Fiyatı (₺)
TPI-101	0,50 - 1,50	1.9	10.0	20.0	10.0	1.7	4.2	0.8	200	0.054	200	0.0825
TPI-102	1,50 - 2,50	1.9	10.0	20.0	10.0	2.3	4.6	0.8	200	0.062	200	0.0880
TPI-106	4,00 - 6,00	2.7	14.0	27.0	13.0	3.4	6.6	1.0	100	0.110	200	0.1870

BIÇAK TİPİ İZOLELİ KABLO UÇLARI

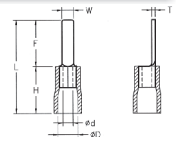

Ürün Kodu	Kablo Kesiti (mm ²)	Civata Ölçüsü	d2	B	F	L	H	d	D	T	Ambalaj Miktarı	Adet Fiyatı (₺)
TPBÇ-10110	0,50 - 1,50	2.3	10.2	20.2	10.0	1.7	4.2	0.8	200	0.088	200	0.1760
TPBÇ-10114	0,50 - 1,50	3	14.5	24.5	10.0	1.7	4.2	0.8	200	0.090	200	0.1760
TPBÇ-1029	1,50 - 2,50	2.8	9.0	19.0	10.0	2.3	4.6	0.8	200	0.110	200	0.2000
TPBÇ-10218	1,50 - 2,50	2.2	18.2	28.2	10.0	2.3	4.6	0.8	200	0.120	200	0.2000
TPBÇ-5018	4,00 - 6,00	4.5	18.2	31.2	13.0	3.4	6.6	1.0	100	0.250	200	0.4400

ÇATAL TİP İZOLELİ KABLO UÇLARI

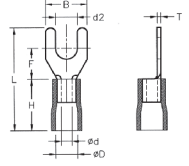

Ürün Kodu	Kablo Kesiti (mm ²)	Civata Ölçüsü	d2	B	F	L	H	d	D	T	Ambalaj Miktarı	Adet Fiyatı (₺)
TPÇ-3001	0,50 - 1,50	M3	3.2	5.8	6.3	21.0	10.0	1.7	4.2	0.8	200	0.0660
TPÇ-3501		M3,5	3.7	5.8	6.3	21.0					200	0.0770
TPÇ-4001		M4	4.3	6.4	6.3	6.3					200	0.0770
TPÇ-5001		M5	5.3	8.1	7.0	21.7					200	0.0880
TPÇ-6001		M6	6.4	9.5	7.0	21.0					200	0.1000
TPÇ-3002	1,50 - 2,50	M3	3.2	5.8	6.5	21.2	21.0	2.3	4.6	0.8	200	0.0770
TPÇ-3502		M3,5	3.7	5.8	6.5	21.2					200	0.0860
TPÇ-4002		M4	4.3	6.4	6.5	21.2					200	0.0880
TPÇ-5002		M5	5.3	9.5	7.0	21.7					200	0.0935
TPÇ-6002		M6	6.4	12.0	11.0	27.4					200	0.1100
TPÇ-4006	4,00 - 6,00	M4	4.3	8.3	7.5	26.0	13.0	3.4	6.6	1.1	100	0.1490
TPÇ-5006		M5	5.3	9.5	7.5	25.7					100	0.1540
TPÇ-6006		M6	6.4	12.0	12.0	31.7					100	0.1820
TPÇ-8006		M8	8.4	13.5	12.2	31.7					100	0.2550

ERKEK / DIŞİ GERİ DÖNÜŞLÜ TERMİNALLER (Extra Bakır Yüksüklü)

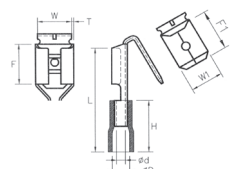

Ürün Kodu	Kablo Kesiti (mm ²)	W	F	L	H	d	D	T	Ambalaj Miktarı	Adet Fiyatı (₺)
TPFDEG-1861	0,50-1,50	6.6	7.8	21.5	10.5	1.7	4.0	0.8	200	0.2700
TPFDEG-2862	1,50-2,50			21.5	10.5	2.3	4.9		200	0.2700
TPFDEG-5866	4,00-6,00			24.0	13.0	3.4	6.7		100	0.3800

NAYLON TAM İZOLELİ DIŞİ FASTON TİP KABLO UÇLARI

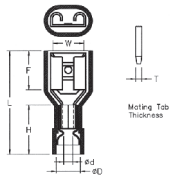

Ürün Kodu	Kablo Kesiti (mm ²)	W	F	L	H	d	D	T	Ambalaj Miktarı	Adet Fiyatı (₺)
TPNFD-1638	0,50-1,50	6.6	7.8	22.5	11.0	1.7	4.2	0.8	200	0.2800
TPNFD-2638	1,50-2,50	6.6	7.8	22.5	11.0	2.3	5.0	0.8	100	0.2900
TPNFD-5638	4,00-6,00	6.6	7.8	24.5	13.0	3.4	6.0	0.8	100	0.4000

DIŐI FASTON TİP İZOLELİ KABLO UÇLARI

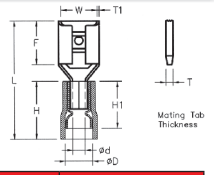

Ürün Kodu	Kablo Kesiti (mm ²)	W	F	L	H	d	D	T	Ambalaj Miktarı	Adet Fiyatı (₺)
TPFD-1288	0,50-1,50	3.2	6.4	18.9	10.5	1.7	4.1	0.8	200	0.1000
TPFD-1488		5	6.4	19.5					200	0.1100
TPFD-1638		6.6	7.8	21.5					200	0.1270
TPFD-2288	1,50-2,50	3.2	6.4	18.9	10.5	2.3	4.9	0.8	200	0.1100
TPFD-2488		5	6.4	19.5					200	0.1220
TPFD-2638		6.6	7.8	21.5					200	0.1320
TPFD-5638	4,00-6,00	6.6	7.8	24.0	13.0	3.4	6.7	0.8	100	0.2000
TPFD-5956		10	12.0	29.0					100	0.4200

TAM İZOLELİ DIŐI FASTON TİP İZOLELİ KABLO UÇLARI

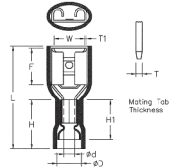

Ürün Kodu	Kablo Kesiti (mm ²)	W	F	L	H	d	D	T	Ambalaj Miktarı	Adet Fiyatı (₺)
TPFFD-1288	0,50 - 1,50	3.2	6.4	19.4	10.5	1.7	4.1	0.8	200	0.1380
TPFFD-1488		5	6.4	20.0					200	0.1450
TPFFD-1638		6.6	7.8	22.0					200	0.1720
TPFFD-2288	1,50 - 2,50	3.2	6.4	19.4	10.5	2.3	4.9	0.8	200	0.1350
TPFFD-2488		5	6.4	20.0					200	0.1550
TPFFD-2638		6.6	7.8	22.0					200	0.1550
TPFFD-5638	4,00-6,00	6.6	7.8	24.5	13.0	3.4	6.7	0.8	100	0.2200

ERKEK FASTON TİP TERMINALLER (Extra Bakır Yüksüklü)

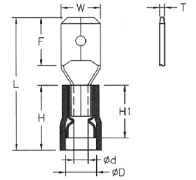

Ürün Kodu	Kablo Kesiti (mm ²)	W	F	L	H	d	D	T	Ambalaj Miktarı	Adet Fiyatı (₺)
TPFE-1288	0,50 - 1,50	2.8	6.6	19.3	10.5	1.7	4.1	0.8	200	0.1000
TPFE-1488		4.8	6.6	19.3			4.5		200	0.1000
TPFE-1638		6.3	7.8	21.5			4.1		200	0.1100
TPFE-2288	1,50 - 2,50	2.8	6.6	19.3	10.5	2.3	5.0	0.8	200	0.0900
TPFE-2488		4.8	6.6	19.3			5.0		200	0.1000
TPFE-2638		6.3	7.8	21.5			4.9		200	0.1100
TPFE-5638	4,00 - 6,00	6.3	7.8	24.0	13.0	3.4	6.7	0.8	100	0.1600

KURŞUN DİŞİ TERMİNALLER İZOLELİ KABLO UÇLARI (Extra Bakır Yüksüklü)

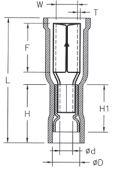
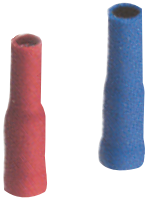

Ürün Kodu	Kablo Kesiti (mm ²)	d2	F	L	H	d	D	Ambalaj Miktarı	Adet Fiyatı (₺)
TPBD-1040	0,50 - 1,50	3.9	8.7	22.5	10.5	1.7	4.1	200	0.190
TPBD-2040	1,50 - 2,50	3.9	8.7	22.5	10.5	2.3	4.9	200	0.190
TPBD-2050	1,50 - 2,50	4.9	8.8	22.5	10.5	2.3	4.9	200	0.190
TPBD-5050	4,00 - 6,00	4.9	8.8	25.0	13.0	3.4	6.7	100	0.290

KURŞUN ERKEK TERMİNALLER İZOLELİ KABLO UÇLARI (Extra Bakır Yüksüklü)

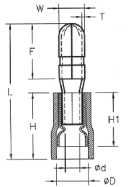

Ürün Kodu	Kablo Kesiti (mm ²)	d2	F	L	H	d	D	Ambalaj Miktarı	Adet Fiyatı (₺)
TPBE-1040	0,50 - 1,50	4	8.7	21.5	10.5	1.7	4.1	200	0.1350
TPBE-2040	1,50 - 2,50	4	8.7	21.5	10.5	2.3	4.9	200	0.1420
TPBE-2050	1,50 - 2,50	5	8.9	21.5	10.5	2.3	4.9	200	0.1420
TPBE-5050	4,00 - 6,00	5	8.9	24.0	13.0	3.4	6.7	100	0.1800

NAYLON TAM İZOLELİ BAYRAK TİP TERMİNALLER

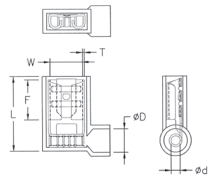

Ürün Kodu	Kablo Kesiti (mm ²)	W	F	L	H	d	D	T	Ambalaj Miktarı	Adet Fiyatı (₺)
TPFDEB-1861	0,50-1,50	6.6	7.8	21.5	10.5	1.7	4.0	0.8	100	0.2200
TPFDEB-2862	1,50-2,50			21.5	10.5	2.3	4.9		100	0.2400

İZOLELİ EK MUFLAR



Ürün Kodu	Kablo Kesiti (mm ²)	L	d	D	Ambalaj Miktarı	Adet Fiyatı (₺)
TPBY-251	0,50-1,50	26.0	1.7	4.1	200	0.1300
TPBY-252	1,50-2,50	26.0	2.3	4.5	200	0.1450
TPBY-256	4,00-6,00	26.0	3.4	6.3	100	0.2000

W OTOMAT BARALARI

TRİFAZE MÜŞTEREK W OTOMAT BARALARI

Ürün Kodu	Açıklama	Modül Adedi	Kutu Adedi	Adet Fiyatı (₺)
TBART-52940	1 mm Elektrolitik Bakır 53 cm	10	25	18.50
TBART-52960	1 mm Elektrolitik Bakır 106 cm	20	25	37.50
TBART-52941	1,5 mm Elektrolitik Bakır 53 cm	10	25	27.00
TBART-52961	1,5 mm Elektrolitik Bakır 106 cm	20	25	55.00
TBART-52966	Trifaze Bara Nihayet Kapağı	-	300	0.080

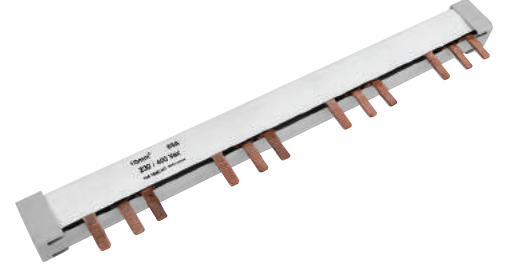

MONOFAZE MÜŞTEREK W OTOMAT BARALARI

Ürün Kodu	Açıklama	Modül Adedi	Kutu Adedi	Adet Fiyatı (₺)
TBARM-52943	1 mm Elektrolitik Bakır 53 cm	30	50	7.70
TBARM-52963	1 mm Elektrolitik Bakır 106 cm	60	20	15.50
TBARM-52942	1,5 mm Elektrolitik Bakır 53 cm	30	50	10.50
TBARM-52962	1,5 mm Elektrolitik Bakır 106 cm	60	20	21.00

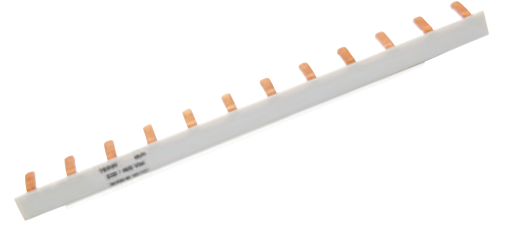

NÖTR TOPRAKLAMA BARALARI

Ürün Kodu	Açıklama	Modül Adedi	Kutu Adedi	Adet Fiyatı (₺)
TBARN-52944	15 mm x 1,5 mm x 1 m	31	20	18.00
TBARN-52948	15 mm x 1,5 mm x 1 m	61	20	20.50
TBARN-52945	15 mm x 2 mm x 1 m	31	20	22.50
TBARN-52949	15 mm x 2 mm x 1 m	61	20	25.00
TBARN-52946	15 mm x 3 mm x 1 m	31	20	34.00
TBARN-52947	15 mm x 3 mm x 1 m	61	20	37.00

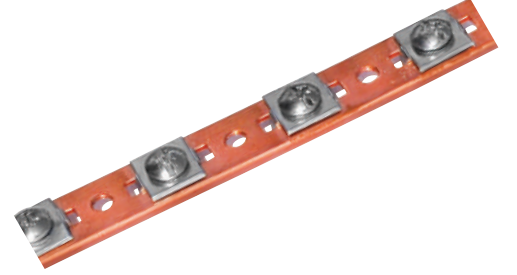

NÖTR BARA MESNEDİ

KOD	AÇIKLAMA	KUTU AD.	FİYAT ₺
TBARN-52950	Nötr Bara Mesnedi	150	0,90



EŞ POTANSİYEL BARALAR

KOD	AÇIKLAMA	KUTU AD.	FİYAT ₺
TBARE-52925	30 x 3 21 cm 5 civatalı	1	29.00
TBARE-52931	30 x 3 25 cm 10 civatalı	1	35.00
TBARE-52926	30 x 3 30 cm 7 civatalı	1	37.00
TBARE-52927	30 x 5 21 cm 5 civatalı	1	40.00
TBARE-52928	30 x 5 30 cm 7 civatalı	1	51.00
TBARE-52929	30 x 5 40 cm 9 civatalı	1	65.00
TBARE-52930	30 x 5 50 cm 12 civatalı	1	80.00

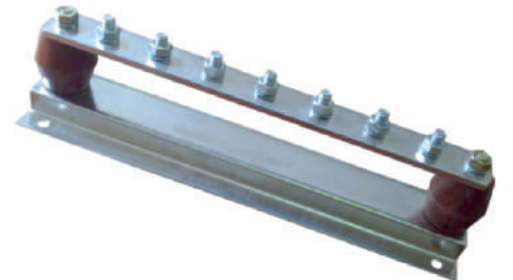

DAĞITICI ÜNİTELER



Ürün Kodu	Açıklama	Ebat			Adet (t)
		En	Boy	Yükseklik	
TDUNT-207	2 kutup 7 delik 125A	65	44	50	11.50
TDUNT-215	2 kutup 15 delik 125A	135	114		18.00
TDUNT-407	4 kutup 7 delik 125A	65	44		21.00
TDUNT-410	4 kutup 10 delik 125A	100	79		25.00
TDUNT-412	4 kutup 12 delik 125A	100	79		27.00
TDUNT-415	4 kutup 15 delik 125A	135	114		33.50

MONTAJ RAYLARI

35x7,5

DÜZ SAC RAYLAR

KOD	AÇIKLAMA	UZUNLUK	KOLİ AD.	FİYAT ₺
52902	Düz Sac Ray	30 cm	50	0.84
52901	Düz Sac Ray	1m.	50	2.50
52911	Düz Sac Ray	2m.	50	5.00



35x7,5

DELİKLİ SAC RAYLAR

KOD	AÇIKLAMA	UZUNLUK	KOLİ AD.	FİYAT ₺
52904	Delikli Sac Ray	30 cm	50	0.85
52903	Delikli Sac Ray	1m.	50	2.56
52913	Delikli Sac Ray	2m.	50	5.12



DÜZ ALÜMİNYUM RAYLAR

KOD	AÇIKLAMA	UZUNLUK	KOLİ AD.	FİYAT ₺
52905	Düz Alüminyum Ray	1m.	35	8.75
52906	Düz Alüminyum Ray	30 cm.	35	2.90



DELİKLİ ALÜMİNYUM RAYLAR

KOD	AÇIKLAMA	UZUNLUK	KOLİ AD.	FİYAT ₺
52907	Delikli Alüminyum Ray	1m.	35	8.80
52908	Delikli Alüminyum Ray	30 cm.	35	3.00



ALÜMİNYUM RAY TAŞIYICI

KOD	AÇIKLAMA	KOLİ AD.	FİYAT ₺
52951	Alüminyum Ray Taşıyıcı	150	1.10



SAC RAY TAŞIYICI

KOD	AÇIKLAMA	KOLİ AD.	FİYAT ₺
52956	Sac Ray Taşıyıcı	150	0.85



ŞARJLI PABUÇ SIKMA PENSELERİ

TPNSS-EZ-240



TEKNİK BİLGİLER

Sıkma Kuvveti	: 5 Ton
Sıkma Sayısı	: 170 (Cu 150 mm ²)
Voltaj	: 18V
Kapasite	: 3.0Ah
Şarj Süresi	: 2 Saat

AKSESUARLAR

Çeneler	: 16-25-35-50-70-95-120-150-185-240
Makita Şarj Edilebilir Batarya	18V 3,0Ah
Makita Şarj Cihazı	
Plastik Çanta	

FİYAT (USD)

Set Fiyatı	: 2.300 USD
(Pense - Şarj Cihazı - Batarya)	
Şarj Cihazı	: 250 USD
Batarya	: 250 USD

ŞARJLI PABUÇ SIKMA PENSELERİ

TPNSS-EZ-300B



TEKNİK BİLGİLER

Sıkma Kuvveti	: 6 Ton
Sıkma Sayısı	: 300 (Cu 150 mm ²)
Voltaj	: 18V
Kapasite	: 3.0Ah
Şarj Süresi	: 2 Saat

AKSESUARLAR

Çeneler	: 16-25-35-50-70-95-120-150-185-240-300
Makita Şarj Edilebilir Batarya	18V 3,0Ah
Makita Şarj Cihazı	
Plastik Çanta	

FİYAT (USD)

Set Fiyatı	: 2.350 USD
(Pense - Şarj Cihazı - Batarya)	
Şarj Cihazı	: 250 USD
Batarya	: 250 USD

ŞARJLI PABUÇ SIKMA PENSELERİ

TPNSS-EZ-300



TEKNİK BİLGİLER

Sıkma Kuvveti	: 6 Ton
Sıkma Sayısı	: 320 (Cu 150 mm ²)
Voltaj	: 18V
Kapasite	: 3.0Ah
Şarj Süresi	: 2 Saat

AKSESUARLAR

Çeneler	: 16-25-35-50-70-95-120-150-185-240-300
Makita Şarj Edilebilir Batarya	18V 3,0Ah
Makita Şarj Cihazı	
Plastik Çanta	

FİYAT (USD)

Set Fiyatı	: 2.800 USD
(Pense - Şarj Cihazı - Batarya)	
Şarj Cihazı	: 250 USD
Batarya	: 250 USD

ŞARJLI PABUÇ SIKMA PENSELERİ

TPNSS-EZ-400



TEKNİK BİLGİLER

Sıkma Kuvveti	: 12 Ton
Sıkma Sayısı	: 120 (Cu 150 mm ²)
Voltaj	: 18V
Kapasite	: 3.0Ah
Şarj Süresi	: 2 Saat

AKSESUARLAR

Çeneler	: 16-25-35-50-70-95-120-150-185-240-300-400
Makita Şarj Edilebilir Batarya	18V 3,0Ah
Makita Şarj Cihazı	
Plastik Çanta	

FİYAT (USD)

Set Fiyatı	: 3.000 USD
(Pense - Şarj Cihazı - Batarya)	
Şarj Cihazı	: 250 USD
Batarya	: 250 USD

ŞARJLI KABLO KESME MAKASLARI

TMKSS-EZ-20



TEKNİK BİLGİLER

Kesme Kuvveti	: 5 Ton
Kesme Kapasitesi	: 20 mm Cu/Alu
Voltaaj	: 18V
Kapasite	: 3.0Ah
Şarj Süresi	: 2 Saat

AKSESUARLAR

Makita Şarj Edilebilir Batarya 18V 3,0Ah
Makita Şarj Cihazı
Plastik Çanta

FİYAT (USD)

Set Fiyatı	: 2.000 USD
(Pense - Şarj Cihazı - Batarya)	
Şarj Cihazı	: 250 USD
Batarya	: 250 USD

ŞARJLI KABLO KESME MAKASLARI

TMKSS-EZ-45



TEKNİK BİLGİLER

Kesme Kuvveti	: 6 Ton
Kesme Kapasitesi	: 45 mm Cu/Alu
Voltaj	: 18V
Kapasite	: 3.0Ah
Şarj Süresi	: 2 Saat

AKSESUARLAR

Makita Şarj Edilebilir Batarya 18V 3,0Ah
Makita Şarj Cihazı
Plastik Çanta

FİYAT (USD)

Set Fiyatı	: 2.400 USD
(Pense - Şarj Cihazı - Batarya)	
Şarj Cihazı	: 250 USD
Batarya	: 250 USD



TMKSS-EZ-85



TEKNİK BİLGİLER

Kesme Kuvveti	: 6 Ton
Kesme Kapasitesi	: 85 mm Cu/Alu
Voltaj	: 18V
Kapasite	: 3.0Ah
Şarj Süresi	: 2 Saat

AKSESUARLAR

Makita Şarj Edilebilir Batarya 18V 3,0Ah
Makita Şarj Cihazı
Plastik Çanta

FİYAT (USD)

Set Fiyatı	: 2.650 USD
(Pense - Şarj Cihazı - Batarya)	
Şarj Cihazı	: 250 USD
Batarya	: 250 USD



Multi-functional



PABUÇ SIKMA - KABLO KESME - PANÇ DELME 3'ü BİR ARADA

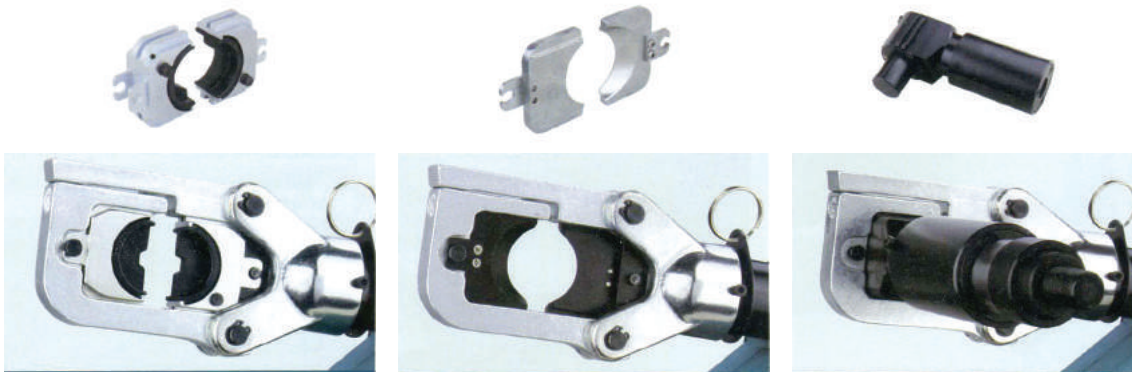

ŞARJLI PABUÇ SIKMA - KABLO KESME - PANÇ DELME 3'ü BİR ARADA

TPNSS-EZ-60UNV



TEKNİK BİLGİLER

Sıkma Kuvveti	: 6 Ton
Sıkma Sayısı	: 160 (Cu 150 mm ²)
Kesme Kapasitesi	: 40 mm ²
Kesme Sayısı	: 70
Voltaj	: 18V
Kapasite	: 3.0Ah
Şarj Süresi	: 2 Saat

AKSESUARLAR

Çeneler	: 16-25-35-50-70-95-120-150-185-240-300
Panç Lokmaları	: 22.5-28.3-34.6-43.2-49.6-61.5
Makita Şarj Edilebilir Batarya	18V 3,0Ah
Makita Şarj Cihazı	
Plastik Çanta	

FİYAT (USD)

Set Fiyatı	: 3.200 USD
(Pense - Şarj Cihazı - Batarya)	
Şarj Cihazı	: 250 USD
Batarya	: 250 USD

ŞARJLI POMPA

TPMPS-EZP-60



TEKNİK BİLGİLER

Basınç	: 70 Mpa
Voltaaj	: 18V
Kapasite	: 3.0Ah
Şarj Süresi	: 2 Saat

AKSESUARLAR

Makita Şarj Edilebilir Batarya 18V 3,0Ah
Makita Şarj Cihazı
Plastik Çanta

FİYAT (USD)

Set Fiyatı	: 1.500 USD
(Pense - Şarj Cihazı - Batarya)	
Şarj Cihazı	: 250 USD
Batarya	: 250 USD

HİDROLİK PABUÇ SIKMA - KABLO KESME - PANÇ DELME 3'ü BİR ARADA

TPNSH-HZ-60UNV

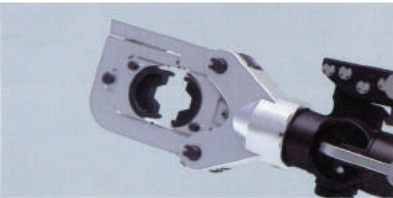

TEKNİK BİLGİLER

Sıkma Kuvveti	: 6 Ton
Sıkma Kapasitesi	: Cu 16-300 mm Alu 10-240 mm
Kesme Kapasitesi	: 40 mm Cu/Alu
Ağırlık	: 3.5 Kg.

AKSESUARLAR

Çeneler	: 16-25-35-50-70-95-120-150-185-240-300
Panç Lokmaları	: 22.5-28.3-34.6-43.2-49.6-61.5
Bıçak	: 1Tk.
Metal Çanta	

FİYAT (USD)

Set Fiyatı	: 1.400 USD
------------	--------------------

HİDROLİK PABUÇ SIKMA PENSELERİ

TPNSH-THS-150



TEKNİK BİLGİLER

Sıkma Kuvveti	: 6 Ton
Sıkma Kapasitesi	: Cu 10-150 mm
Ağırlık	: 2.2 Kg.

AKSESUARLAR

Çeneler	: 10-16-25-35-50-70-95-120-150
Plastik Çanta	

FİYAT (USD)

Set Fiyatı	: 650 USD
------------	------------------

TPNSH-HZ-300



TEKNİK BİLGİLER

Sıkma Kuvveti	: 6 Ton
Sıkma Kapasitesi	: Cu 16-300 mm
Ağırlık	: 3.5 Kg.

AKSESUARLAR

Çeneler	: 16-25-35-50-70-95-120-150-185-240-300
Metal Çanta	

FİYAT (USD)

Set Fiyatı	: 850 USD
------------	------------------

HİDROLİK PABUÇ SIKMA PENSELERİ

TPNSH-HZ-400



TEKNİK BİLGİLER

Sıkma Kuvveti	: 12 Ton
Sıkma Kapasitesi	: Cu 16-400 mm
Ağırlık	: 6.5 Kg.

AKSESUARLAR

Çeneler	: 16-25-35-50-70-95-120-150-185-240-300-400
Metal Çanta	

FİYAT (USD)

Set Fiyatı	: 1.100 USD
------------	--------------------

TPNSH-HZ-400U



TEKNİK BİLGİLER

Sıkma Kuvveti	: 12 Ton
Sıkma Kapasitesi	: Cu 16-400 mm
Ağırlık	: 5.3 Kg.

AKSESUARLAR

Çeneler	: 16-25-35-50-70-95-120-150-185-240-300-400
Metal Çanta	

FİYAT (USD)

Set Fiyatı	: 1.150 USD
------------	--------------------

TPNSH-CYO-400C



TEKNİK BİLGİLER

Sıkma Kuvveti	: 12 Ton
Sıkma Kapasitesi	: Cu 16-400 mm
Ağırlık	: 6.8 Kg.

AKSESUARLAR

Çeneler	: 16-25-35-50-70-95-120-150-185-240-300-400
Metal Çanta	

FİYAT (USD)

Set Fiyatı	: 950 USD
------------	------------------

HİDROLİK PABUÇ SIKMA PENSELERİ



TPNSH-YQK-70



TEKNİK BİLGİLER

Sıkma Kuvveti	: 4.5 Ton
Sıkma Kapasitesi	: Cu 4-70 mm
Ağırlık	: 1.8 Kg.

AKSESUARLAR

Çeneler	: 4-6-10-16-25-35-50-70
Plastik Çanta	

FİYAT (USD)

Set Fiyatı	: 125 USD
------------	------------------

TPNSH-YYQ-120



TEKNİK BİLGİLER

Sıkma Kuvveti	: 6 Ton
Sıkma Kapasitesi	: Cu 10-120 mm
Ağırlık	: 2.8 Kg.

AKSESUARLAR

Çeneler	: 10-16-25-35-50-70-95-120
Plastik Çanta	

FİYAT (USD)

Set Fiyatı	: 140 USD
------------	------------------

TPNSH-YYQ-120A



TEKNİK BİLGİLER

Sıkma Kuvveti	: 6 Ton
Sıkma Kapasitesi	: Cu 10-120 mm
Ağırlık	: 3.2 Kg.

AKSESUARLAR

Çeneler	: 10-16-25-35-50-70-95-120
Plastik Çanta	

FİYAT (USD)

Set Fiyatı	: 160 USD
------------	------------------

HİDROLİK PABUÇ SIKMA PENSELERİ

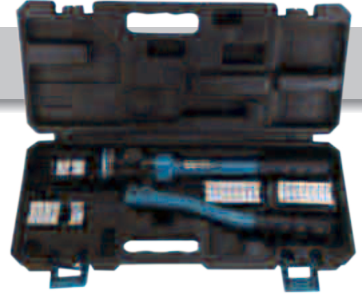

TPNSH-YQK-240



TEKNİK BİLGİLER

Sıkma Kuvveti	: 7 Ton
Sıkma Kapasitesi	: Cu 16-240 mm
Ağırlık	: 3.6 Kg.

AKSESUARLAR

Çeneler	: 16-25-35-50-70-95-120-150-185-240
Plastik Çanta	

FİYAT (USD)

Set Fiyatı	: 170 USD
------------	------------------

TPNSH-YQK-300



TEKNİK BİLGİLER

Sıkma Kuvveti	: 7 Ton
Sıkma Kapasitesi	: Cu 10-300 mm
Ağırlık	: 3.6 Kg.

AKSESUARLAR

Çeneler	: 10-16-25-35-50-70-95-120-150-185-240-300
Plastik Çanta	

FİYAT (USD)

Set Fiyatı	: 185 USD
------------	------------------

TPNSH-KYQ-300



TEKNİK BİLGİLER

Sıkma Kuvveti	: 10 Ton
Sıkma Kapasitesi	: Cu 16-300 mm
Ağırlık	: 4.6 Kg.

AKSESUARLAR

Çeneler	: 16-25-35-50-70-95-120-150-185-240-300
Plastik Çanta	

FİYAT (USD)

Set Fiyatı	: 420 USD
------------	------------------

HİDROLİK KABLO KESME MAKASLARI

TMKSH-HZ-45



TEKNİK BİLGİLER

Kesme Kuvveti	: 6 Ton
Kesme Kapasitesi	: 45mm Cu / Alu
Ağırlık	: 4.8 Kg.

AKSESUARLAR

Metal Çanta

FİYAT (USD)

Set Fiyatı	: 900 USD
------------	------------------

TMKSH-HZ-85



TEKNİK BİLGİLER

Kesme Kuvveti	: 6 Ton
Kesme Kapasitesi	: 85mm Cu / Alu
Ağırlık	: 7.6 Kg.

AKSESUARLAR

Metal Çanta

FİYAT (USD)

Set Fiyatı	: 1.300 USD
------------	--------------------

HİDROLİK KABLO KESME MAKASLARI

TMKSH-CPC-40A



TEKNİK BİLGİLER

Kesme Kuvveti	: 6 Ton
Kesme Kapasitesi	: 32mm Cu / Alu
Ağırlık	: 5.2 Kg.

AKSESUARLAR

Metal Çanta

FİYAT (USD)

Set Fiyatı : **400 USD**

TMKSH-CPC-50A



TEKNİK BİLGİLER

Kesme Kuvveti	: 6 Ton
Kesme Kapasitesi	: 45mm Cu / Alu
Ağırlık	: 7.1 Kg.

AKSESUARLAR

Metal Çanta

FİYAT (USD)

Set Fiyatı : **500 USD**

HİDROLİK DEMİR KESME MAKASLARI

TMKSH-CPC-16A



TEKNİK BİLGİLER

Kesme Kuvveti	: 6 Ton
Kesme Kapasitesi	: 4-16mm
Ağırlık	: 3.4 Kg.

AKSESUARLAR

Plastik Çanta

FİYAT (USD)

Set Fiyatı : **170 USD**

TMKSH-CPC-22A



TEKNİK BİLGİLER

Kesme Kuvveti	: 10 Ton
Kesme Kapasitesi	: 4-22mm
Ağırlık	: 4.2 Kg.

AKSESUARLAR

Plastik Çanta

FİYAT (USD)

Set Fiyatı : **190 USD**

HİDROLİK POMPALAR

TPMP-CP-700



TEKNİK BİLGİLER

El Tipi	
Basınç Kuvveti	: 70 Mpa
Ağırlık	: 9 Kg.

FİYAT (USD)

Set Fiyatı	: 600 USD
------------	------------------

TPMP-CFP-800



TEKNİK BİLGİLER

Ayak Tipi	
Basınç Kuvveti	: 70 Mpa
Ağırlık	: 10.6 Kg.

FİYAT (USD)

Set Fiyatı	: 700 USD
------------	------------------

HİDROLİK PABUÇ SIKMA BAŞLIKLARI

TPNSH-CO-400B



Fiyatı : **350 USD**

TEKNİK BİLGİLER

Sıkma Kuvveti	: 15.5 Ton
Sıkma Kapasitesi	: Cu 16-400 mm
Ağırlık	: 6.5 Kg.

AKSESUARLAR

Çeneler	: 16-25-35-50-70-95-120-150-185-240-300-400
Plastik Çanta	

TPNSH-FYQ-630



Fiyatı : **800 USD**

TEKNİK BİLGİLER

Sıkma Kuvveti	: 32 Ton
Sıkma Kapasitesi	: Cu 150-630 mm
Ağırlık	: 10.8 Kg.

AKSESUARLAR

Çeneler	: 150-185-240-300-400-500-630
Metal Çanta	

TPNSH-FYQ-630A



Fiyatı : **950 USD**

TEKNİK BİLGİLER

Sıkma Kuvveti	: 32 Ton
Sıkma Kapasitesi	: Cu 150-630 mm
Ağırlık	: 15.4 Kg.

AKSESUARLAR

Çeneler	: 150-185-240-300-400-500-630
Metal Çanta	

TPNSH-FYQ-1000



Fiyatı : **1.500 USD**

TEKNİK BİLGİLER

Sıkma Kuvveti	: 50 Ton
Sıkma Kapasitesi	: Cu 400-1000 mm
Ağırlık	: 27.4 Kg.

AKSESUARLAR

Çeneler	: 400-500-630-800-1000
Metal Çanta	

HİDROLİK KABLO KESME BAŞLIKLARI

TMKSH-CPC-40B



TEKNİK BİLGİLER

Kesme Kuvveti	: 6 Ton
Kesme Kapasitesi	: 40mm Cu / Alu
Ağırlık	: 3.8 Kg.

AKSESUARLAR

Metal Çanta

FİYAT (USD)

Set Fiyatı : **600 USD**

TMKSH-CPC-85B



TEKNİK BİLGİLER

Kesme Kuvveti	: 6 Ton
Kesme Kapasitesi	: 85mm Cu / Alu
Ağırlık	: 7.9 Kg.

AKSESUARLAR

Metal Çanta

FİYAT (USD)

Set Fiyatı : **700 USD**

TMKSH-CPC-100B



TEKNİK BİLGİLER

Kesme Kuvveti	: 6 Ton
Kesme Kapasitesi	: 100mm Cu / Alu
Ağırlık	: 8.4 Kg.

AKSESUARLAR

Metal Çanta

FİYAT (USD)

Set Fiyatı : **900 USD**

MEKANİK PABUÇ SIKMA PENSELERİ

TPNSM-JT-150



TEKNİK BİLGİLER

Sıkma Kuvveti	: 3.5 Ton
Sıkma Kapasitesi	: Cu 10-150 mm
Ağırlık	: 2.4 Kg.

AKSESUARLAR

Çeneler	: 10-16-25-35-50-70-95-120-150
Plastik Çanta	

FİYAT (USD)

Set Fiyatı	: 300 USD
------------	------------------

TPNSM-JT-300



TEKNİK BİLGİLER

Sıkma Kuvveti	: 4 Ton
Sıkma Kapasitesi	: Cu 16-300 mm
Ağırlık	: 4 Kg.

AKSESUARLAR

Çeneler	: 16-25-35-50-70-95-120-150-185-240-300
Plastik Çanta	

FİYAT (USD)

Set Fiyatı	: 400 USD
------------	------------------

MEKANİK PABUÇ SIKMA PENSELERİ

TPNSM-JY-0650A



TEKNİK BİLGİLER

Sıkma Kapasitesi	: Cu 6-50 mm
Ağırlık	: 1.5 Kg.

FİYAT (USD)

Set Fiyatı	: 70 USD
------------	-----------------

TPNSM-JY-06120



TEKNİK BİLGİLER

Sıkma Kapasitesi	: Cu 6-120 mm
Ağırlık	: 3.8 Kg.

FİYAT (USD)

Set Fiyatı	: 120 USD
------------	------------------

TPNSM-JY-25150



TEKNİK BİLGİLER

Sıkma Kapasitesi	: Cu 25-150 mm
Ağırlık	: 3.8 Kg.

FİYAT (USD)

Set Fiyatı	: 130 USD
------------	------------------

TPNSM-JY-70240



TEKNİK BİLGİLER

Sıkma Kapasitesi	: Cu 70-240 mm
Ağırlık	: 4.1 Kg.

FİYAT (USD)

Set Fiyatı	: 150 USD
------------	------------------

MEKANİK KABLO KESME MAKASLARI

TMKSM-TCR-325



TEKNİK BİLGİLER

Kesme Kapasitesi	: 240mm ² Cu / Alu
Ağırlık	: 0.7 Kg.

Fiyatı : **170 USD**

TMKSM-TCR-500



TEKNİK BİLGİLER

Kesme Kapasitesi	: 400mm ² Cu / Alu
Ağırlık	: 1 Kg.

Fiyatı : **250 USD**

TMKSM-TCR-500S



TEKNİK BİLGİLER

Teleskopik kollar, güç gerektiren işlemler içindir.	
Kesme Kapasitesi	: 400mm ² Cu / Alu
Ağırlık	: 1 Kg.

Fiyatı : **250 USD**

MEKANİK KABLO KESME MAKASLARI



Ürün Kodu	Kapasite (mm ²)	Uzunluk (mm)	Ağırlık (kg)	Adet Fiyatı (USD)
TMKSM-YYR-513	60	-----	-----	32.00

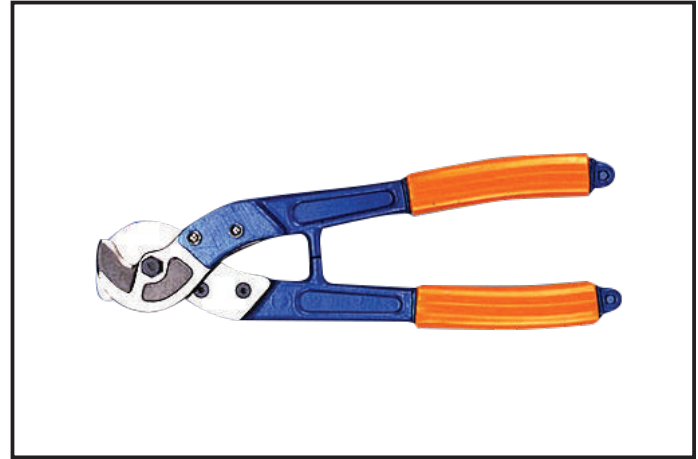

Ürün Kodu	Kapasite (mm ²)	Uzunluk (mm)	Ağırlık (kg)	Adet Fiyatı (USD)
TMKSM-YYR-514	100	-----	-----	65.00



Ürün Kodu	Kapasite (mm ²)	Uzunluk (kg)	Ağırlık (kg)	Adet Fiyatı (USD)
TMKSM-TC-125S	120 (4x16)	300-400	1.25	130



Ürün Kodu	Kapasite (mm ²)	Uzunluk (mm)	Ağırlık (kg)	Adet Fiyatı (USD)
TMKSM-TC-250C	240 (3x20+170)	415-565	2.28	150



Ürün Kodu	Kapasite (mm ²)	Uzunluk (mm)	Ağırlık (kg)	Adet Fiyatı (USD)
TMKSM-TC-100	120	320	0.70	50
TMKSM-TC-250	240	600	1.80	100
TMKSM-TC-500	500	810	2.25	150

YÜKSÜK SIKMA PENSELERİ

TMALT-YAC5

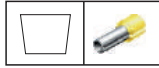

0.5 - 6mm²

45.00 USD

TMALT-YAC6

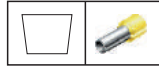

6.0 - 16 mm²

45.00 USD

TMALT-YAC8

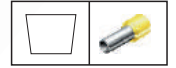

İzolesiz Kablo Ucu
0.5-6 mm²

55.00 USD

TMALT-YAC35

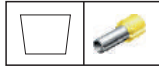

10 - 35 mm²

45.00 USD

TMALT-YAC50

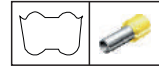

25 - 50 mm²

45.00 USD

TMALT-MLT3SET

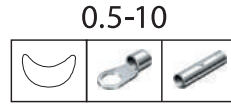

0.5-10

0.5-10

0.5 - 10 mm²

95.00 USD

TMALT-YYT21



0.75 - 10 mm²

30.00 USD

KABLO UCU SIKMA PENSELERİ

TMALT-YYT1



İzoleli Kablo Ucu
0.5 - 6 mm²

40.00 USD

TMALT-YYT7



İzoleli Kablo Ucu
1.0 - 6 mm²

40.00 USD

TMALT-YYT11



İzolesiz Terminal
1-4 mm²

45.00 USD

TMALT-YYT8



Kaynaklı Pabuç Sıkma
0.5 - 10 mm²

40.00 USD

TMALT-HD-16L



Pabuç Sıkma
1.25 - 16 mm²

35.00 USD

TMALT-HD-50L



Pabuç Sıkma
5.5 - 50 mm²

65.00 USD

TMALT-T03-5D

Multi fonksiyonel Yüksük ve Kablo ucu sıkma

Takım içeriği

- YAC-5 ————— Yüksük sıkma 0.5 - 6 mm
- YAC-6 ————— Yüksük sıkma 6 - 16 mm
- YYT-1 ————— Kablo ucu sıkma 0.5 - 6 mm
- YYT-11 ————— İzolesiz terminal 1 - 4 mm
- YYT-8 ————— Kaynaklı pabuç sıkma 0.5 - 10 mm



130.00 USD

KONNEKTÖR SIKMA PENSELERİ

TMALT-DMR723



RJ11-RJ12-RJ45
(6P-8P)

60.00 USD

TMALT-AN315



RJ10-RJ11-RJ45
(4P-6P-8P)

30.00 USD

KABLO BAĞI SIKMA PENSELERİ

TG-010



3,6-9 mm

35.00 USD

TMALT-TG328



Çelik Kablo Bağı Sıkma
4.8 - 7.5 mm

280.00 USD

HİDROLİK PANÇ DELME

TMALT-360 PANÇ



360° döner kafa panç delme
Set Ø 22.5 - 28.3 - 34.6 - 43.2 - 49.6 - 61.5 mm
Max: 3 mm sac

550.00 USD

KABLO SIYIRMA PENSELERİ**TMALT-YY-78/318**

0.5 - 6 mm

20.00 USD**TMALT-TP-700B**

0.5-6 mm

5.00 USD**TMALT-AP-6**

0.8-6 mm

30.00 USD**TMALT-ALY-25/6**

0.5 - 2.5 mm

15.00 USD**TMALT-ALCS-312B****17.00 USD****TMALT-SK-30**

Ø 15-30 mm

100.00 USD**TMALT-SK-40**

Ø 20-40 mm

300.00 USD

TORK®

Kablo bağı bizim işimiz....



TORK ELEKTROTEKNİK SAN. ve TİC. LTD. ŞTİ.

Merkez : Ferhatpaşa Mah. G-3 Sok. No: 114 /B 34758 Ataşehir - İstanbul / TÜRKİYE

Tel : +90 216 471 35 35 Faks : +90 216 471 35 34

Şube : Okçu Musa Cad. Menevşe Han No: 22 Kat: 1 D : 129 Karaköy - İstanbul / TÜRKİYE

Tel : +90 212 237 91 72 Faks : +90 212 237 91 79

tork@torkelektroteknik.com

www.torkelektroteknik.com