



Fiyatlarımıza KDV Dahil Deđildir.



www.izeltas.com.tr

www.izeltas.com.tr

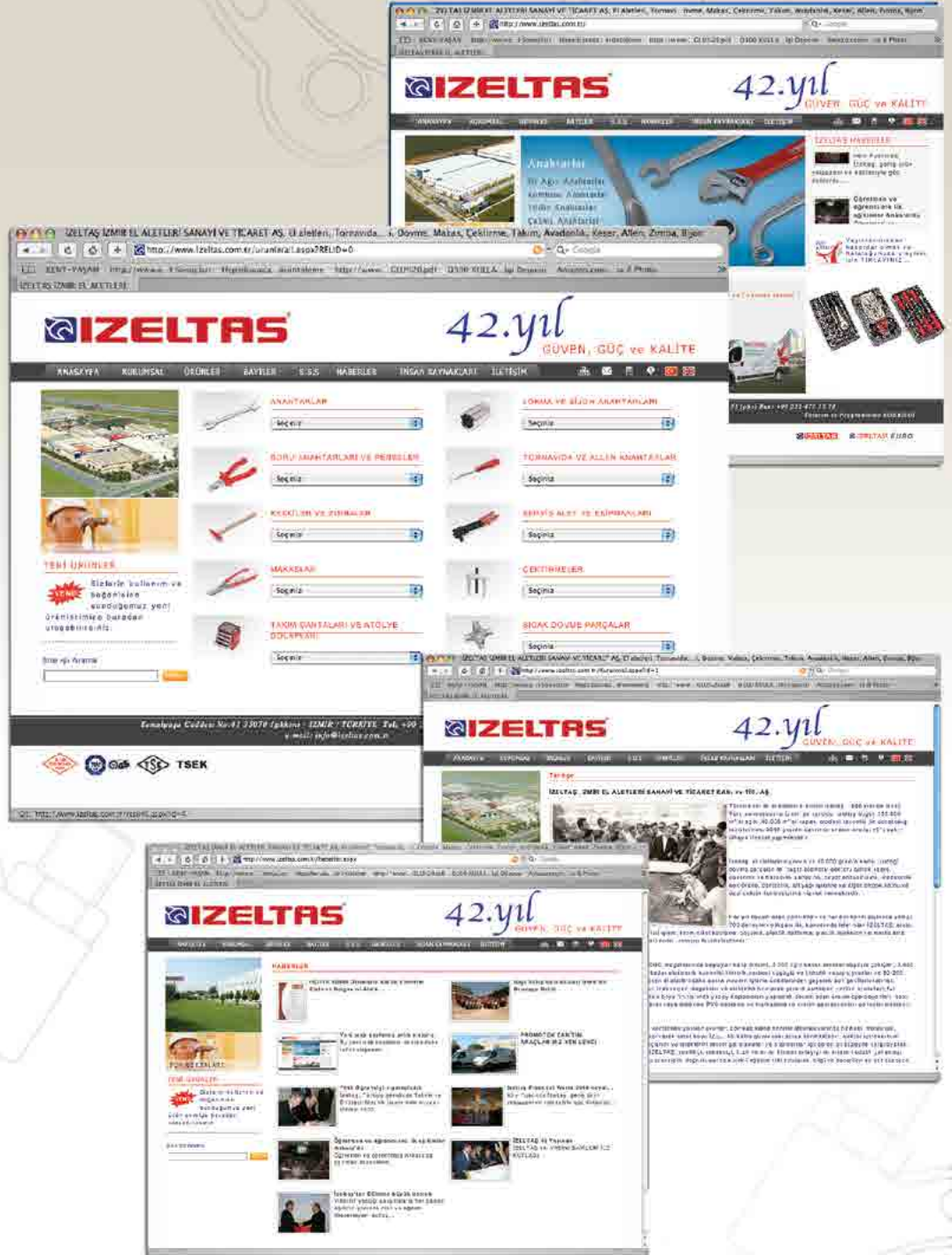

www.izeltas.com.tr
www.izeltas.com.tr





IZELTAS®

İZELTAŞ, 1968 yılında Türk – Alman teknik işbirliği ve yüzde yüz Türk sermayesi ile ilk Türk el aletleri fabrikası olarak İzmir’de kurulmuştur.

Kuruluşundan itibaren yapılan kapasite arttırıcı ve kalite iyileştirici teknolojik yatırımlarla İZELTAŞ, 155 bin metrekarelik açık alan üzerine kurulu 45 bin metrekarelik kapalı alanda faaliyet göstermektedir. Üretim tesislerinde, yıllık 4000 ton'a karşılık 16 milyon adet/yıl olarak 3 bin çeşit el aleti üretilmektedir.

İZELTAŞ, kalıphane, dövme, işleme, ısıl işlem, elektrolitik kaplama, plastik enjeksiyon ve boyama departmanlarına sahip komple bir tesistir.

Sıcak dövme metodu ile 30kg 'a kadar üretilen yüksek kaliteli el aletleri ve muhtelif sıcak dövme parçaları; otomotiv sektörü, savunma sanayi, ziraat endüstrisi, inşaat sektörü, makine imalat sanayii gibi bir çok sektörde güvenle kullanılmaktadır.

Daima yüksek kalite ve zengin ürün çeşidini hedefleyen İZELTAŞ, sahip olduğu ISO 9001, ISO/TS 16949 belgeli yönetim sistemleri, TSE ve TÜV GS kalite belgeleri ve yüksek teknolojisi ile bugün Türkiye’de olduğu kadar, Avrupa, Asya, Afrika, Kuzey ve Güney Amerika’da İZELTAŞ markası altında önemli bir pazara sahiptir.

Çevreye, insan sağlığına ve iş güvenliğine verdiğimiz önem sonucu, ilgili yönetmelik ve standartlara uygun yapılan çalışmalar ile 2009 yılında, ISO 14001 Çevre Yönetim Sistemi ve OHSAS TS 18001 İş Sağlığı ve Güvenliği Yönetim Sistemi belgesi alınmıştır.

Kurmuş olduğumuz Ar-Ge merkezi ve Kalite, Çevre ve İş Sağlığı ve Güvenliliği Yönetim Sistemleri ile en iyiyi sunabilmek ve satış sonrası sınırsız hizmet güvencesi, İZELTAŞ’ın vazgeçilmez şirket politikasıdır.

Tüm dünyaya hitap edebilecek kalitede mal üretmek ve dünya çapında aranılan bir marka olmak temel amacımızdır.

İZELTAŞ'a güven duyan ve destek veren tüm müşterilerimize ve İZELTAŞ kullanıcılarına sonsuz teşekkürler...





İZELTAŞ was established in 1968 in İzmir as the first Turkish hand tools manufacturer through Turkish and German technical collaboration.

Today, İZELTAŞ, as the result of technological investments, that increase capacity and improve quality, has a production capacity of 4000 tons a year, equivalent to 16 million pieces and 3000 types of hand tools with three manufacturing facilities covering a total area of 155.000 square meters, of which 45.000 square meter is closed.

İZELTAŞ is a complete facility, including die-tooling, forging, machining, heat treatment, electroplating, plastic injection and painting departments.

Ergonomic, high quality hand tools and various forged parts from 50 grams up to 30 kg. produced by hot forging method are used in sectors such as; automotive, defense, agriculture, aviation and construction.

İZELTAŞ, aiming high quality and a wide range of products, is certified with ISO 9001 and ISO/TS 16949 for its quality management and TSE, TUV GS quality systems. As a consequence, İZELTAŞ owns a good reputation for its high quality products and advanced technology throughout Europe, Asia, Africa, North and South America as well as in Turkey.

As a result of the importance given to the protection of environment and human health, İZELTAŞ has acquired the certificate of ISO 14001 Environmental management System and OHSAS 18001 Occupational Health and Safety Management System in 2009.

We thank a lot all İZELTAŞ users and customers who support and trust in İzeltaş.



Anahtarlar
Wrenches

6 - 21



1

Lokma ve Bijon Anahtarları
Sockets and Rim Wrenches

24 - 43



2

Boru Anahtarları ve Penseler
Pipe Wrenches and Pliers

46 - 61



3

Tornavida ve Allen Anahtarlar
Screwdrivers and Hex Key Wrenches

64 - 79



4

Keskiler ve Çekiçler
Chisels and Hammers

82 - 85



5

Servis Alet ve Ekipmanları
Maintenance Tools and Equipment

87 - 95



6

Makaslar
Shears

98 - 101



7

Çektirmeler
Pullers

104 - 110



8

Takım Çantaları ve Atölye Dolapları
Workshop Furniture

112 - 132



9

Teknik Bilgi
Technical Information

134 - 139



10

MCD



Klasik Profil
Conventional Profile

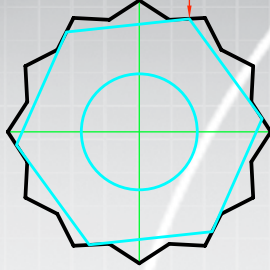

İzeltaş Yeni Jenerasyon Yıldız Anahtar Profili

MCD, Multi Contact Drive (çoklu temas), sıkma performansının geliştirilmesi amacıyla dizayn edilmiştir. Bilgisayar destekli titiz çalışmaların sonucunda geliştirilen MCD, klasik 12 köşe anahtardan çok daha kullanışlı, çok daha güçlüdür.

En önemli özelliği, yıldız kafadaki çoklu temas yüzeyleridir. Bu sayede civata ve somunla maksimum temas sağlanır. Böylece basınç tüm köşelere eşit olarak dağılarak, temas edilen yüzeylerdeki olası hasarlar önlenir, aletin ömrü uzar.

Çoklu Temas / Multi Point Contact

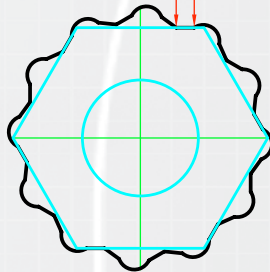

MCD Profil
MCD Profile

• Yıldız kafadaki yeni profil, düzenli bir dalga şeklindedir. Güç, civatanın köşelerine değil, yan yüzeylerine etki eder (çoklu temas). Basınç daha dengeli dağıldığından temas edilen yüzeylerde ezilme meydana gelmez.

- Tolerans dışı civatalar için de uygundur.
- Civata başlarının köşelerini ezmez.
- Geniş temas alanı, anahtar ömrünü artırır.
- Bozuk ve deforme olmuş civataları kolayca açar.

IZELTAS New Generation Ring Wrench Profile

MCD (Multi Contact Drive) is designed to improve the driving performance of the ring wrench. MCD, designed through computer aided drafting, transmits more torque and has longer life than conventional 12 edge ring profile.

Multi point contact is the source of effectiveness, where maximum surface area is in touch with fastener flats. Increased contact also maximizes tool life through decreased pressure on the contact points.

• New profile of the ring wrench is formed of curves. Torque is transmitted through these curves rather than edges. As the stress is balanced between enlarged surfaces, the risk of deformation is minimized.

- It is possible to drive off-tolerance fasteners.
- Does not deform the fastener edges.
- Larger contact area increases tool life.
- Works well with deformed fasteners.

MONTAJ ANAHTARI / SPEED WRENCH



%100 Daha Hızlı

Yeni tasarlanan montaj anahtarı, 2 kat hızını cırcır mekanizması mantığına dayanan çalışma prensibinden alır. Kullanım sırasında, montaj anahtarını civatadan ayırmadan döndürme kolaylığı kullanım hızını artırırken, civata köşelerine sağlam tutunan anahtar profili güvenli ve kaydırmaz kullanım sağlar.

Uzun Ömür

Bu yeni montaj anahtarı profili, civata ve somunlar ile köşelerinden değil düz yüzeyleri üzerinden temas ederek düzenli tork iletimini sağlarken, gerilimin artmasını da engelleyerek anahtar ömrünün uzamasını sağlar.

- Anahtarı civatadan ayırmadan hızlı kullanım.
- Güvenli tork iletimi ve uzun ömür.

100% Faster

New designed speed wrench takes its 100% faster rotational drive from the ratchet mechanism principle. Rotating the tool without the need for removing from the fastener provides faster usage, while enabling safer and slip-free usage with fully gripping upper and lower jaws.

Longer Tool Life

This new speed wrench profile contacts the fasteners from their flats rather than edges, which provides balanced torque transmission and decreases stress accumulation on the edges increasing the tool life considerably.

- Fast drive without removing the wrench from the fastener.
- Firm torque transmission and longer life.

Anahtarlar

Wrenches

1

İki Ağız Anahtarlar
Kombine Anahtarlar
Yıldız Anahtarlar
Çakma Anahtarlar
Kurbağacık Anahtarlar

Open Jaw Wrenches
Combination Wrenches
Ring Wrenches
Slugging Wrenches
Adjustable Wrenches



İki Ağız Anahtar Kısa Boy (mm)
Double Ended Open Jaw Wrench
Short Pattern (mm)

 TS 81 • DIN 895

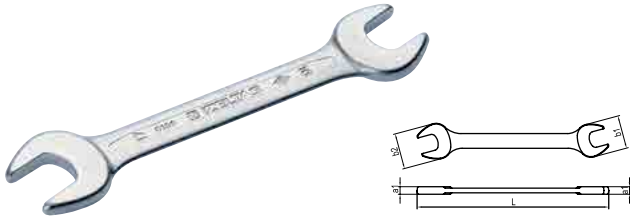

Krom vanadyum, Krom kaplı
Chrom vanadium, Chrom plated

KOD CODE	mm	L mm	a1 mm	b1 mm	b2 mm	g	TL/Ad.	
0100 01 0405	04x05	97	3.5	11	12.5	15	10	6,73
0100 01 0607	06x07	97	3.5	14	16	18	10	6,91
0100 01 0608	06x08	108	3.5	14	18	20	10	-----
0100 01 0708	07x08	108	3.5	16	18	20	10	-----
0100 01 0709	07x09	108	4	16	20	25	10	-----
0100 01 0809	08x09	108	4	18	20	30	10	7,02
0100 01 0810	08x10	117	4.6	18	22	33	10	7,25
0100 01 0910	09x10	120	4.6	20	22	30	10	-----
0100 01 0911	09x11	120	4.6	20	24	30	10	-----
0100 01 1011	10x11	120	4.6	22	24	41	10	7,70
0100 01 1012	10x12	120	4.6	22	26	35	10	7,70
0100 01 1013	10x13	120	4.6	22	28	38	10	8,23
0100 01 1014	10x14	133	5.2	22	30	50	10	-----
0100 01 1113	11x13	133	5.2	26	28	50	10	-----
0100 01 1114	11x14	133	5.2	24	30	50	10	8,46
0100 01 1213	12x13	133	5.2	26	28	57	10	8,46
0100 01 1214	12x14	147	5.2	26	30	59	10	8,46
0100 01 1314	13x14	147	5.2	28	30	66	10	8,46
0100 01 1315	13x15	147	5.8	28	32	65	10	-----
0100 01 1415	14x15	147	5.8	30	32	78	10	9,88
0100 01 1317	13x17	162	6.2	28	36	80	10	11,18
0100 01 1417	14x17	162	6.2	30	36	90	10	11,51
0100 01 1617	16x17	162	6.2	34	36	109	10	11,51
0100 01 1719	17x19	178	7	36	40	143	10	12,33
0100 01 1819	18x19	178	7	38	40	144	10	12,33
0100 01 1820	18x20	178	7	38	42	125	10	13,96
0100 01 1822	18x22	195	7.4	38	46	160	10	13,96
0100 01 1722	17x22	195	7.4	36	46	160	10	-----
0100 01 1922	19x22	195	7.4	40	46	175	10	13,96
0100 01 2022	20x22	195	7.4	42	46	196	10	13,96
0100 01 1924	19x24	213	7.7	40	50	200	10	-----
0100 01 2123	21x23	213	7.7	44	48	230	10	14,60
0100 01 2224	22x24	213	8	46	50	239	10	15,28
0100 01 2226	22x26	232	8	46	54	250	10	-----
0100 01 2227	22x27	232	8.2	46	56	260	10	-----
0100 01 2426	24x26	232	8.2	50	54	297	10	15,73
0100 01 2427	24x27	232	8.2	50	56	296	10	15,73
0100 01 2528	25x28	248	8.6	52	57.5	366	10	19,55
0100 01 2430	24x30	265	9	50	62	370	10	-----
0100 01 2730	27x30	265	9	56	62	380	10	-----
0100 01 2732	27x32	265	9	56	66	415	10	23,35
0100 01 3032	30x32	265	9	62	66	465	10	23,35

İki Ağız Anahtar Takımı Kısa Boy (mm)
Double Ended Open Jaw Wrench
Short Pattern Set (mm)





KOD CODE	İÇERİK CONTENTS	g	TL/Ad.	
0100 00 2106	6x7 - 8x9 - 10x11 12x13 - 14x15 - 16x17	406	6	51,48
0100 00 2108	6x7 - 8x9 - 10x11 12x13 - 14x15 - 16x17 18x19 - 20x22	736	8	77,77
0100 00 2110	6x7 - 8x9 - 10x11 12x13 - 14x15 - 16x17 18x19 - 20x22 - 21x23 24x26	1254	10	108,10
0100 00 2112	6x7 - 8x9 - 10x11 12x13 - 14x15 - 16x17 18x19 - 20x22 - 21x23 24x26 - 25x28 - 30x32	2110	12	151,00

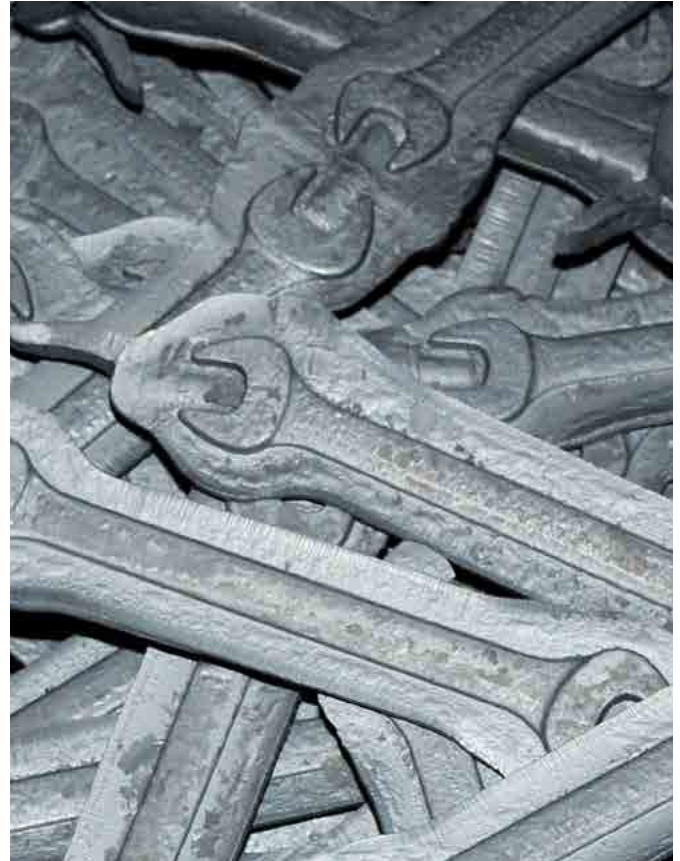

0130

İki Ağız Anahtar Uzun Boy (mm)
Double Ended Open Jaw Wrench
Long Pattern (mm)



TS ISO 10102 • DIN 3110



Krom vanadyum, Krom kaplı
Chrom vanadium, Chrom plated

KOD CODE	mm	L mm	a1 mm	b1 mm	b2 mm	g		TL/Ad.
0130 01 0555	5x5.5	125	3.5	14	16	15	10	-----
0130 01 0607	6x7	125	3.5	14	16	24	10	8,78
0130 01 0608	6x8	125	3.5	14	18	20	10	9,11
0130 01 0708	7x8	125	3.5	16	18	20	10	-----
0130 01 0709	7x9	140	4	16	20	30	10	-----
0130 01 0809	8x9	140	4	18	20	35	10	9,11
0130 01 0810	8x10	140	4	18	22	36	10	9,11
0130 01 0910	9x10	155	4.5	20	22	45	10	-----
0130 01 0911	9x11	155	4.5	20	24	45	10	-----
0130 01 1011	10x11	155	4.5	22	24	47	10	10,09
0130 01 1012	10x12	162	4.7	22	26	57	10	10,09
0130 01 1013	10x13	162	4.7	22	28	61	10	10,09
0130 01 1014	10x14	172	5	22	30	65	10	10,09
0130 01 1113	11x13	172	5	24	28	70	10	-----
0130 01 1114	11x14	172	5	24	30	65	10	10,09
0130 01 1213	12x13	172	5	26	28	67	10	10,64
0130 01 1214	12x14	172	5	26	30	65	10	10,64
0130 01 1314	13x14	188	5.5	28	30	85	10	10,64
0130 01 1315	13x15	188	5.5	30	32	93	10	-----
0130 01 1415	14x15	188	5.5	30	32	91	10	12,39
0130 01 1317	13x17	205	6.2	28	36	111	10	13,52
0130 01 1417	14x17	205	6.2	30	36	106	10	13,52
0130 01 1617	16x17	205	6.2	34	36	120	10	13,67
0130 01 1618	16x18	220	7	34	38	165	10	13,67
0130 01 1719	17x19	220	7	36	40	160	10	14,66
0130 01 1819	18x19	220	7	38	40	161	10	14,66
0130 01 1722	17x22	235	7.5	36	46	190	5	-----
0130 01 1921	19x21	235	7.5	40	44	195	5	17,02
0130 01 1922	19x22	235	7.5	40	46	195	5	17,02
0130 01 2022	20x22	235	7.5	42	46	195	5	17,02
0130 01 1724	17x24	248	8.3	36	50	240	5	-----
0130 01 1924	19x24	248	8.3	40	50	235	5	17,08
0130 01 2123	21x23	248	8.3	44	48	235	5	17,38
0130 01 2224	22x24	248	8.3	46	50	235	5	17,94
0130 01 2227	22x27	265	8.8	46	56	300	5	-----
0130 01 2426	24x26	265	8.8	50	54	300	5	20,43
0130 01 2427	24x27	265	8.8	50	56	300	5	20,43
0130 01 2430	24x30	282	9.3	50	61.5	380	5	22,90
0130 01 2528	25x28	282	9.3	52	57.5	390	5	22,90
0130 01 2729	27x29	300	9.8	56	59	400	5	28,57
0130 01 2730	27x30	300	9.8	56	61.5	440	5	28,57
0130 01 2732	27x32	300	9.8	56	65.5	460	5	28,57
0130 01 3032	30x32	300	9.8	61.5	65.5	480	5	28,57
0130 01 3036	30x36	325	10.4	61.5	76	645	5	54,42
0130 01 3236	32x36	325	10.4	65.5	76	680	5	54,42
0130 01 3436	34x36	330	10.4	71	76	690	5	-----
0130 01 3641	36x41	360	12	76	87	955	5	84,57
0130 01 4146	41x46	400	12.5	87	98	1300	5	130,42
0130 01 4650	46x50	450	13	98	107	1635	5	144,71

0130

İki Ağız Anahtar Takımı Uzun Boy (mm)
Double Ended Open Jaw Wrench
Long Pattern Set (mm)



KOD CODE	İÇERİK CONTENTS	g		TL/Ad.
0130 00 2106	6x7 - 8x9 - 10x11 12x13 - 14x15 - 16x17	450	6	64,68
0130 00 2108	6x7 - 8x9 - 10x11 12x13 14x15 - 16x17 18x19 20x22	815	8	96,36
0130 00 2110	6x7 - 8x9 - 10x11 12x13 - 14x15 - 16x17 18x19 - 20x22 - 21x23 24x26	1435	10	134,17
0130 00 2112	6x7 - 8x9 - 10x11 12x13 - 14x15 - 16x17 18x19 - 20x22 - 21x23 24x26 - 25x28 - 27x32	2315	12	185,64



0132

İki Ağız Anahtar Uzun Boy MASTER (mm) TS ISO 10102 • DIN 3110
Double Ended Open Jaw Wrench
MASTER Long Pattern (mm)

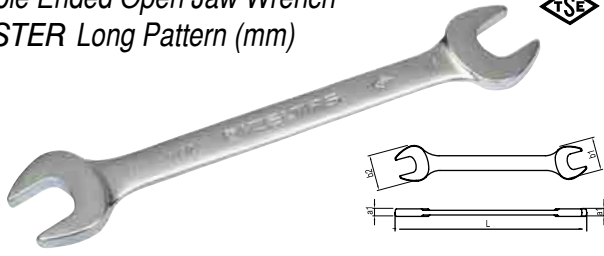

Saten krom yüzeyli, Krom vanadyum, Krom kaplı
 Satin chrom finish, Chrom vanadium, Chrom plated

KOD CODE	mm	L mm	a1 mm	b1 mm	b2 mm	g	TL/Ad.
0132 01 0607	6x07	125	3.5	14	16	20	10, 9,67
0132 01 0809	8x09	140	4	18	20	30	10, 10,03
0132 01 1011	10x11	155	4.5	22	24	45	10, 11,11
0132 01 1213	12x13	172	5	26	28	65	10, 11,72
0132 01 1415	14x15	188	5.5	30	32	85	10, 13,63
0132 01 1617	16x17	205	6.2	34	36	115	10, 15,04
0132 01 1819	18x19	220	7	38	40	160	10, 16,14
0132 01 2022	20x22	235	7.5	42	46	195	5, 18,72
0132 01 2123	21x23	248	8.3	44	48	235	5, 19,11
0132 01 2426	24x26	265	8.8	50	54	300	5, 22,47
0132 01 2528	25x28	282	9.3	52	57.5	390	5, 25,20
0132 01 2732	27x32	300	9.8	56	65.5	460	5, 31,44

0132

İki Ağız Anahtar Takımı Uzun Boy MASTER (mm)
Double Ended Open Jaw Wrench
MASTER Long Pattern Set (mm)



KOD CODE	İÇERİK CONTENTS	g	TL/Ad.
0132 00 2106	6x7 - 8x9 - 10x11 12x13 - 14x15 - 16x17	450	6
0132 00 2108	6x7 - 8x9 - 10x11 12x13 14x15 - 16x17 18x19 20x22	815	8
0132 00 2110	6x7 - 8x9 - 10x11 12x13 - 14x15 - 16x17 18x19 - 20x22 - 21x23 24x26	1435	10
0132 00 2112	6x7 - 8x9 - 10x11 12x13 - 14x15 - 16x17 18x19 - 20x22 - 21x23 24x26 - 25x28 - 27x32	2315	12

0161

İki Ağız Anahtar Uzun Boy (SAE)
Double Ended Open Jaw Wrench
Long Pattern (SAE)

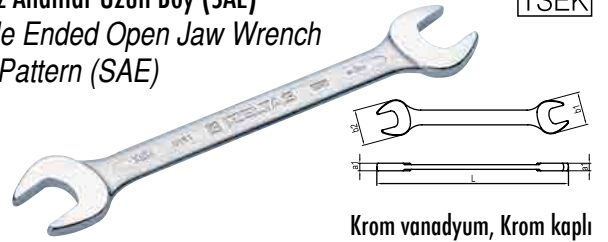

Krom vanadyum, Krom kaplı
 Chrom vanadium, Chrom plated

KOD CODE	inch	L mm	a1 mm	b1 mm	b2 mm	g	TL/Ad.
0161 01 0608	1/4"x5/16"	125	3.5	14	16	20	10, 9,57
0161 01 0809	5/16"x3/8"	140	4	18	20	30	10, 9,88
0161 01 0810	5/16"x11/32"	140	4	18	22	30	10, 10,01
0161 01 0811	5/16"x7/16"	140	4	18	22	30	10, 10,53
0161 01 0911	3/8"x7/16"	155	4.5	22	24	35	10, 11,17
0161 01 1112	7/16"x1/2"	172	5	26	28	40	10, 11,17
0161 01 1214	1/2"x9/16"	172	5	26	30	65	10, 12,57
0161 01 1416	9/16"x5/8"	188	5.5	30	32	85	10, 14,22
0161 01 1417	9/16"x11/16"	205	6.2	30	36	110	10, 14,95
0161 01 1517	19/32"x11/16"	205	6.2	34	36	115	10, 15,73
0161 01 1619	5/8"x3/4"	220	7	36	40	150	10, 17,59
0161 01 1920	3/4"x25/32"	220	7	38	40	160	10, 17,59
0161 01 2021	25/32"x13/16"	235	7.5	40	44	195	10, 17,59
0161 01 1922	3/4"x7/8"	235	7.5	40	46	195	10, 17,59
0161 01 2122	13/16"x7/8"	248	8.3	44	48	235	10, 18,44
0161 01 2325	15/16"x1"	265	8.8	50	54	300	10, 19,91
0161 01 2328	1 5/16"x1 1/8"	265	8.8	50	56	300	10, 22,99
0161 01 2628	1 1/16"x1 1/8"	300	9.8	56	59.5	460	10, 33,06
0161 01 2631	1 1/16"x1 1/4"	300	9.8	56	65.5	460	10, 34,95
0161 01 2833	1 1/8"x1 5/16"	300	9.8	56	65.5	460	10, 34,95

0161

İki Ağız Anahtar Takımı Uzun Boy (SAE)
Double Ended Open Jaw Wrench
Long Pattern Set (SAE)



KOD CODE	İÇERİK CONTENTS	g	TL/Ad.
0161 00 2106	1/4"x5/16" - 5/16"x3/8" - 7/16"x1/2" 9/16"x5/8" - 19/32"x11/16" - 3/4"x25/32"	565	6
0161 00 2108	1/4"x5/16" - 5/16"x3/8" 7/16"x1/2" - 9/16"x5/8" - 19/32"x11/16" - 3/4"x25/32" - 13/16"x7/8" - 15/16"x1"	1090	8
0161 00 2110	1/4"x5/16" - 5/16"x3/8" - 7/16"x1/2" 9/16"x5/8" - 19/32"x11/16" - 3/4"x25/32" 13/16"x7/8" - 15/16"x1" 1 1/16"x1 1/4" - 1 1/8"x1 5/16"	2045	10
0161 00 2112	1/4"x5/16" - 5/16"x3/8" - 3/8"x7/16" - 7/16"x1/2" - 1/2"x9/16" - 9/16"x5/8" 19/32"x11/16" - 3/4"x25/32" 13/16"x7/8" - 15/16"x1" - 1 1/16"x1 1/4" 1 1/8"x1 5/16"	2165	12

0220

İki Ağız Taçlı Anahtar (mm) Double Ended Open Jaw Wrench (mm)

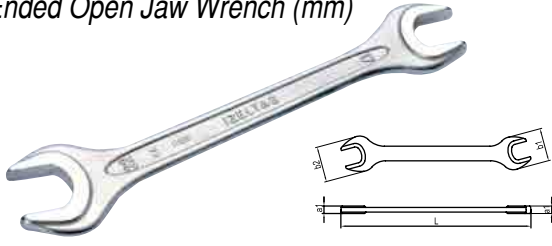

Krom vanadyum, Krom kaplı
Chrom vanadium, Chrom plated

KOD CODE	mm	L mm	a1 mm	b1 mm	b2 mm	g	TL/Ad.
0220 01 1415	14x15	155	5.8	29.6	31.5	50	10
0220 01 1317	13x17	165	6	28.6	35.5	60	10
0220 01 1417	14x17	165	6	29.6	35.5	60	10
0220 01 1617	16x17	165	6	33.5	35.5	65	10
0220 01 1819	18x19	180	7	36.5	38.5	100	10
0220 01 1722	17x22	195	7.5	35.5	44.5	120	10
0220 01 1922	19x22	195	7.5	38.5	44.5	130	10
0220 01 2022	20x22	195	7.5	40.4	44.5	135	10
0220 01 2123	21x23	225	9	42.4	46.3	180	5
0220 01 2224	22x24	225	9	44.5	48.3	180	5
0220 01 2528	25x28	255	11	50.3	56.2	280	5
0220 01 2730	27x30	270	12	54.3	60.2	380	5
0220 01 2732	27x32	270	12	54.3	64	380	5

0250

Bir Ağız Taçlı Anahtar (mm) Single Ended Open Jaw Wrench (mm)

TS 81



Krom vanadyum
Chrom vanadium

KOD CODE	mm	L mm	a1 mm	b1 mm	g	TL/Ad.
0250 01 0021	21	185	8	42.4	95	10
0250 01 0022	22	195	8	44.4	110	10
0250 01 0023	23	195	8	46.3	115	10
0250 01 0024	24	215	9	48.3	150	10
0250 01 0025	25	215	9	50.3	155	10
0250 01 0027	27	240	9.5	54.3	200	5
0250 01 0030	30	260	9.5	60.2	250	5
0250 01 0032	32	270	10	64	300	5
0250 01 0034	34	270	10	68	320	5
0250 01 0036	36	300	10.5	74.6	370	5
0250 01 0038	38	300	10.5	76.8	400	5
0250 01 0041	41	345	12.2	85.5	550	5
0250 01 0046	46	390	14	96.3	750	5
0250 01 0050	50	425	15.2	105	1000	5
0250 01 0055	55	455	16.5	113.5	1300	1
0250 01 0060	60	490	18.4	121	1600	1
0250 01 0065	65	524	19.7	130	1980	1
0250 01 0070	70	564	20.8	140	2480	1
0250 01 0075	75	608	21.8	151	3100	1

0255

Süper İzole Çatal Bir Ağız Anahtar (mm) Single Ended Open Jaw Wrench Super Insulated (mm)



Krom vanadyum, Krom kaplı, PVC izoleli
Chrom vanadium, Chrom plated, PVC insulated

KOD CODE	mm	L mm	g	TL/Ad.
0255 01 0010	10	110	40	16,74
0255 01 0011	11	120	45	17,67
0255 01 0012	12	130	50	17,67
0255 01 0013	13	140	60	19,92
0255 01 0014	14	155	75	20,69
0255 01 0017	17	170	100	25,37
0255 01 0019	19	185	150	29,79
0255 01 0022	22	200	200	40,12
0255 01 0024	24	220	280	49,09

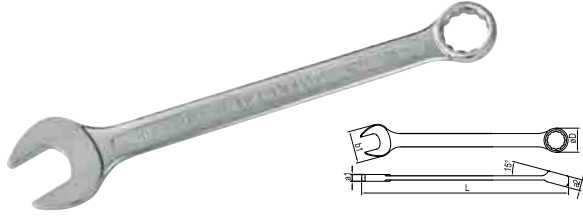

Kombine Anahtar Kısa Boy (mm)
Combination Wrench Short Pattern (mm)

 TS 3794 • DIN 3113

Krom vanadyum, Krom kaplı
Chrom vanadium, Chrom plated

KOD CODE	mm	L mm	a1 mm	a2 mm	b1 mm	øD mm	g	TL/Ad.
0320 02 0005	5	100	3.4	5.1	14	10	15	8,79
0320 02 0055	5.5	100	3.4	5.1	14	10	15	8,79
0320 02 0006	6	100	3.4	5.1	14	10	15	9,11
0320 02 0007	7	110	3.6	5.5	16	11	20	9,70
0320 02 0008	8	120	3.8	5.9	18	13	25	10,53
0320 02 0009	9	130	4	6.3	20	14	30	10,84
0320 02 0010	10	140	4.3	6.9	22	15.5	40	12,21
0320 02 0011	11	150	4.5	7.3	24	17	45	12,57
0320 02 0012	12	160	4.9	7.7	26	18.5	55	13,40
0320 02 0013	13	170	5.2	7.9	28	19.5	60	13,70
0320 02 0014	14	180	5.5	8.7	30	21.5	75	14,83
0320 02 0015	15	190	5.8	9.1	32	22.5	90	15,85
0320 02 0016	16	200	6.1	9.6	34	24	105	17,02
0320 02 0017	17	210	6.4	9.8	36	25.5	120	18,18
0320 02 0018	18	220	6.8	10.4	38	27	145	20,28
0320 02 0019	19	232	7	11	40	28.5	170	21,31
0320 02 0020	20	240	7.2	11.4	42	30	195	21,69
0320 02 0021	21	250	7.4	12	44	31.5	190	25,20
0320 02 0022	22	260	8.2	12.6	46	33	275	28,89
0320 02 0023	23	270	8.3	13	48	35	255	28,89
0320 02 0024	24	280	8.5	13.6	50	36.5	320	35,33
0320 02 0025	25	290	8.8	14	52	39	320	35,33
0320 02 0026	26	300	9	14.8	54	41	400	41,64
0320 02 0027	27	310	9.3	15	56	41.5	400	41,64
0320 02 0028	28	320	9.4	15.4	57.5	42.5	380	41,64
0320 02 0029	29	330	10	15.6	59	43.5	510	47,69
0320 02 0030	30	340	10.3	16	61.5	44	505	47,69
0320 02 0032	32	370	10.5	16.2	65.5	47	560	50,16
0320 02 0034	34	400	10.7	16.8	71	50	675	52,49

Kombine Anahtar Takımı Kısa Boy (mm)
Combination Wrench Short Pattern Set (mm)

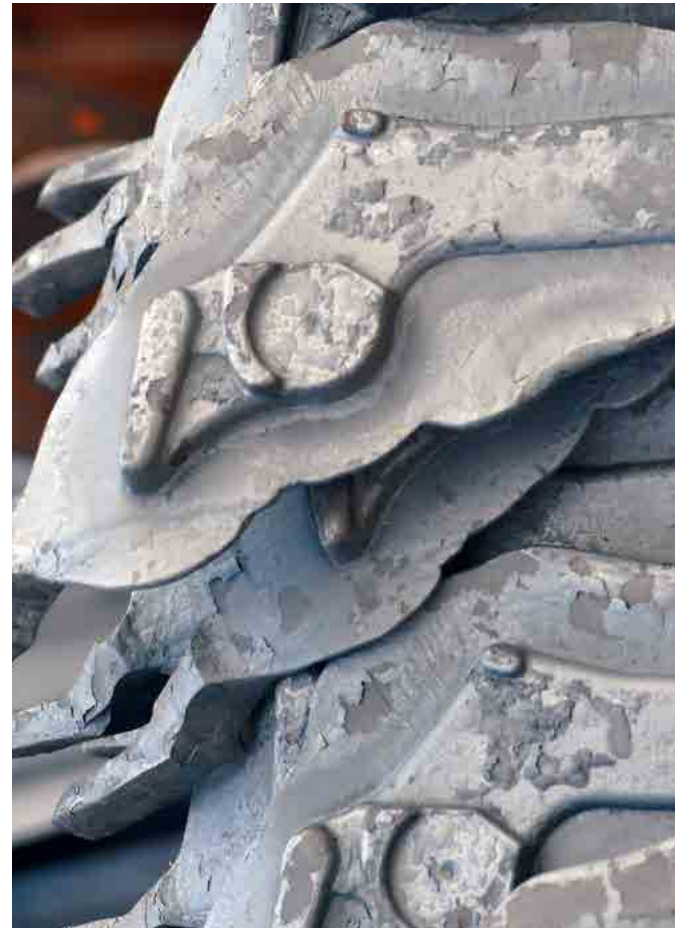
KOD CODE	İÇERİK CONTENTS	g	TL/Ad.
0320 00 2106	8 - 9 - 11 - 13 - 17 - 19	460	6 87,13
0320 00 2108	6 - 7 - 8 - 9 - 10 - 13 17 - 19	475	8 105,58
0320 00 2110	8 - 9 - 10 - 11 - 12 - 13 14 - 17 19 - 22	1015	10 156,46
0320 00 2112	8 - 9 - 10 - 11 - 12 13 - 14 - 15 - 16 17 - 19 - 22	1190	12 189,33
0320 00 2117	6 - 7 - 8 - 9 - 10 11 - 12 - 13 - 14 15 - 16 - 17 - 18 19 - 20 - 21 - 22	1760	17 275,31
0320 00 2121	6 - 7 - 8 - 9 - 10 11 - 12 - 13 - 14 15 - 16 - 17 - 18 19 - 20 - 21 - 22 24 - 27 - 30 - 32	3650	21 450,13



0322

Kombine Anahtar Kısa Boy MASTER (mm) Combination Wrench MASTER Short Pattern (mm)

TS 3794 • DIN 3113



Saten krom yüzeyli, Krom vanadyum, Krom kaplı
Satin chrom finish, Chrom vanadium, Chrom plated

KOD CODE	mm	L mm	a1 mm	a2 mm	b1 mm	øD mm	g	TL/Ad.
0322 02 0006	6	100	3.4	5.1	14	10	15	10,03
0322 02 0007	7	110	3.6	5.5	16	11	20	10,68
0322 02 0008	8	120	3.8	5.9	18	13	25	11,57
0322 02 0009	9	130	4	6.3	20	14	30	11,90
0322 02 0010	10	140	4.3	6.9	22	15.5	40	13,43
0322 02 0011	11	150	4.5	7.3	24	17	45	13,84
0322 02 0012	12	160	4.9	7.7	26	18.5	55	14,75
0322 02 0013	13	170	5.2	7.9	28	19.5	60	15,07
0322 02 0014	14	180	5.5	8.7	30	21.5	75	16,31
0322 02 0015	15	190	5.8	9.1	32	22.5	90	17,44
0322 02 0016	16	200	6.1	9.6	34	24	105	18,72
0322 02 0017	17	210	6.4	9.8	36	25.5	120	20,01
0322 02 0018	18	220	6.8	10.4	38	27	145	22,31
0322 02 0019	19	232	7	11	40	28.5	170	23,45
0322 02 0020	20	240	7.2	11.4	42	30	195	23,86
0322 02 0021	21	250	7.4	12	44	31.5	190	27,74
0322 02 0022	22	260	8.2	12.6	46	33	275	31,78

0322

Kombine Anahtar Takımı Kısa Boy MASTER (mm) Combination Wrench MASTER Short Pattern Set (mm)



KOD CODE	İÇERİK CONTENTS	g	TL/Ad.
0322 00 2106	8 - 9 - 11 - 13 - 17 - 19	460	6
0322 00 2108	6 - 7 - 8 - 9 - 10 - 13 - 17 - 19	475	8
0322 00 2110	8 - 9 - 10 - 11 - 12 - 13 - 14 - 17 - 19 - 22	1015	10
0322 00 2112	8 - 9 - 10 - 11 - 12 - 13 - 14 - 15 - 16 - 17 - 19 - 22	1190	12
0322 00 2117	6 - 7 - 8 - 9 - 10 - 11 - 12 - 13 - 14 - 15 - 16 - 17 - 18 - 19 - 20 - 21 - 22	1755	17

0325

Montaj Anahtar (mm) Speed Wrench (mm)

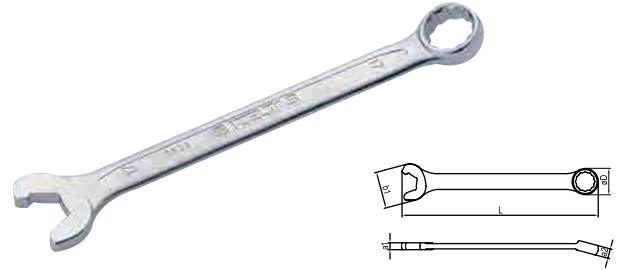

Krom vanadyum, Krom kaplı
Chrom vanadium, Chrom plated

KOD CODE	mm	L mm	a1 mm	a2 mm	b1 mm	øD mm	g	TL/Ad.	
0325 02 0010	10	130	4.3	6.9	22	15.5	35	10	15,26
0325 02 0013	13	160	5.2	7.9	28	19.5	45	10	17,13
0325 02 0017	17	200	6.4	9.8	36	25.5	110	10	22,70
0325 02 0019	19	220	7	11	40	28.5	155	10	26,61
0325 02 0020	20	235	7.2	11.4	42	30	180	10	27,10
0325 02 0021	21	245	7.4	12	44	31.5	180	10	31,50
0325 02 0022	22	255	8.2	12.6	46	33	245	10	36,12



Kombine Anahtar Uzun Boy (mm)
*Combination Wrench,
Long Pattern (mm)*

TS 3794 • DIN 3113

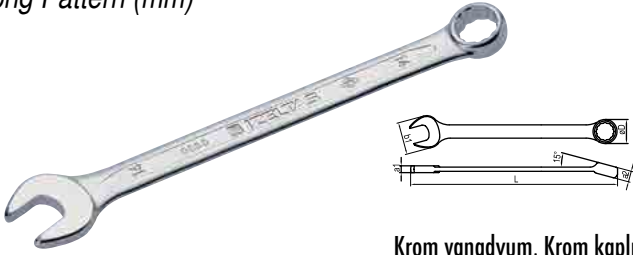

Krom vanadyum, Krom kaplı
Chrom vanadium, Chrom plated

KOD CODE	mm	L mm	a1 mm	a2 mm	b1 mm	σD mm	g	TL/Ad.
0330 02 0005	5	95	3.2	5.2	12.5	9	20	10,16
0330 02 0055	5.5	100	3.4	5.4	13.5	9.5	20	10,16
0330 02 0006	6	105	3.8	5.6	14	10.5	20	10,16
0330 02 0007	7	117	4	6.1	16	12	20	10,16
0330 02 0008	8	130	4.2	6.6	18	13.5	30	11,89
0330 02 0009	9	141	4.5	7	20	15	40	12,07
0330 02 0010	10	154	4.7	7.6	22	16	50	13,40
0330 02 0011	11	166	5	8.2	24	17.5	60	14,12
0330 02 0012	12	178	5.2	8.7	26	19	70	14,12
0330 02 0013	13	190	5.6	9.2	28	20.5	80	15,94
0330 02 0014	14	203	5.8	9.7	30	22	100	16,56
0330 02 0015	15	215	6.4	10.1	32	23.5	115	17,63
0330 02 0016	16	227	6.4	10.8	34	25	135	17,93
0330 02 0017	17	239	6.6	11.4	36	26.5	160	20,28
0330 02 0018	18	250	7	12	38	28	186	21,99
0330 02 0019	19	263	7.3	12.7	40	29.5	205	23,83
0330 02 0020	20	275	7.7	13.2	42	31	235	25,32
0330 02 0021	21	288	8.1	13.3	44	31.5	260	27,03
0330 02 0022	22	300	8.5	13.7	46	34	300	32,09
0330 02 0023	23	315	8.8	14.2	48	35.5	300	39,28
0330 02 0024	24	330	9	14.2	50	37	390	39,28
0330 02 0025	25	340	9.3	14.7	52	38.5	380	39,28
0330 02 0026	26	350	9.7	14.7	54	40	475	46,27
0330 02 0027	27	360	10	15.2	56	41	475	46,27
0330 02 0028	28	370	10.4	15.7	57.5	43	475	46,27
0330 02 0029	29	390	10.8	16.2	59	44	610	46,27
0330 02 0030	30	410	11.2	16.6	61.5	45	610	53,12
0330 02 0032	32	420	11.5	17.1	65.5	48	755	55,73
0330 02 0034	34	430	11.8	17.4	71	51	735	56,83
0330 02 0036	36	440	12.2	17.7	76	53	1000	64,39
0330 02 0038	38	450	12.5	18.7	80	56	1000	65,92
0330 02 0041	41	480	13.5	19.7	87	61	1240	75,02
0330 02 0046	46	505	14.7	20.7	95	67.5	1635	97,53
0330 02 0050	50	540	15.9	22.7	104	73.5	2100	117,02

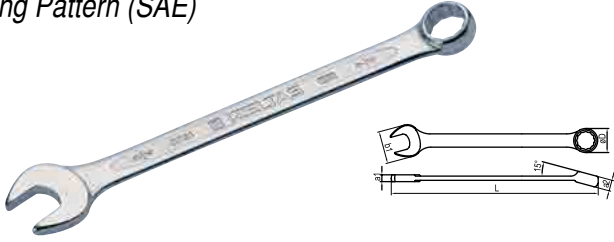

Kombine Anahtar Takımı Uzun Boy (mm)
*Combination Wrench
Long Pattern Set (mm)*

KOD CODE	İÇERİK CONTENTS	g	TL/Ad.
0330 00 2106	8 - 9 - 11 - 13 - 17 - 19	615	6 98,13
0330 00 2108	6 - 7 - 8 - 9 - 10 - 13 17 - 19	665	8 117,73
0330 00 2110	8 - 9 - 10 - 11 - 12 - 13 14 - 17 - 19 - 22	1230	10 174,30
0330 00 2112	8 - 9 - 10 - 11 - 12 13 - 14 - 15 - 16 17 - 19 - 22	1780	12 209,86
0330 00 2117	6 - 7 - 8 - 9 - 10 - 11 12 - 13 - 14 - 15 - 16 17 - 18 - 19 - 20 - 21 22	2170	17 304,52
0330 00 2121	6 - 7 - 8 - 9 - 10 - 11 12 - 13 - 14 - 15 - 16 17 - 18 - 19 - 20 - 21 22 - 24 - 27 - 30 - 32	4465	21 498,92

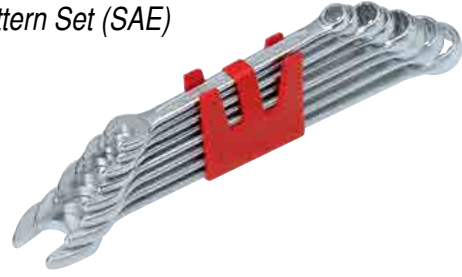

0331
Kombine Anahtar Uzun Boy (SAE)
Combination Wrench
Long Pattern (SAE)
TSEK

Krom vanadyum, Krom kaplı
Chrom vanadium, Chrom plated

KOD CODE	inch	L mm	a1 mm	a2 mm	b1 mm	σD mm	g	TL/Ad.
0331 02 0005	3/16"	95	3.2	5.2	12.5	9	15	11,66
0331 02 0006	1/4"	105	3.8	5.6	14	10.5	20	13,40
0331 02 0008	5/16"	130	4.2	6.6	18	13.5	30	15,61
0331 02 0010	3/8"	154	4.7	7.6	22	16	50	17,78
0331 02 0011	7/16"	166	5	8.2	24	17.5	60	18,71
0331 02 0013	1/2"	190	5.6	9.2	28	20.5	80	21,10
0331 02 0014	9/16"	203	5.8	9.7	30	22	100	22,25
0331 02 0015	19/32"	215	6.4	10.1	32	23.5	115	23,52
0331 02 0016	5/8"	227	6.4	10.8	34	25	135	25,31
0331 02 0017	11/16"	239	6.6	11.4	36	26.5	155	26,95
0331 02 0019	3/4"	263	7.3	12.7	40	29.5	205	31,44
0331 02 0020	25/32"	275	7.7	13.2	42	31	230	33,66
0331 02 0021	13/16"	288	8.1	13.3	44	31.5	260	5 37,17
0331 02 0022	7/8"	300	8.5	13.7	46	34	310	5 42,79
0331 02 0024	15/16"	330	9	14.2	50	37	380	5 52,39
0331 02 0025	1"	340	9.3	14.7	52	38.5	380	5 52,39
0331 02 0027	1 1/16"	360	10	15.2	56	41	470	5 61,34
0331 02 0028	1 1/8"	370	10.4	15.7	57.5	43	470	5 61,34
0331 02 0030	1 3/16"	410	11.2	16.6	61.5	45	635	5 70,28
0331 02 0032	1 1/4"	420	11.5	17.1	65.5	48	775	5 73,70
0331 02 0033	1 5/16"	430	11.8	17.4	71	51	775	5 73,70
0331 02 0035	1 3/8"	440	12.2	17.7	76	53	1015	5 ----
0331 02 0036	1 7/16"	440	12.2	17.7	76	53	1015	5 ----
0331 02 0038	1 1/2"	450	12.5	18.7	80	56	1015	5 89,07
0331 02 0041	1 5/8"	480	13.5	19.7	87	61	1325	5 ----
0331 02 0046	1 13/16"	505	14.7	20.7	95	67.5	1750	5 ----
0331 02 0050	2"	540	15.9	22.7	104	73.5	2200	5 ----

0331
Kombine Anahtar Takımı Uzun Boy (SAE)
Combination Wrench
Long Pattern Set (SAE)
TSEK

KOD CODE	İÇERİK CONTENTS	g	TL/Ad.
0331 00 2106	3/8" - 7/16" - 1/2" - 9/16" - 5/8" - 3/4"	685	6 136,59
0331 00 2108	5/16" - 3/8" - 7/16" - 1/2" 9/16" 5/8" 11/16" - 3/4"	925	8 179,15
0331 00 2110	5/16" - 3/8" - 7/16" - 1/2" - 9/16" 5/8" - 11/16" - 3/4" 13/16" - 7/8"	1250	10 259,11
0331 00 2112	5/16" - 3/8" - 7/16" - 1/2" - 9/16" 5/8" - 11/16" - 3/4" - 13/16" - 7/8" 15/16" - 1"	2320	12 363,89
0331 00 2117	1/4" - 5/16" - 3/8" - 7/16" 1/2" 9/16" - 19/32" 5/8" - 11/16" - 3/4" - 25/32" - 13/16" 7/8" - 15/16" - 1" 1 1/16" - 1 3/16"	3875	17 566,09
0331 00 2120	1/4" - 5/16" - 3/8" - 7/16" 1/2" - 9/16" - 19/32" - 5/8" 11/16" 3/4" - 25/32" 13/16" - 7/8" - 15/16" 1" - 1 1/16" - 1 1/8" 1 3/16" - 1 1/4" - 1 5/16"	5880	20 774,83

0335
Çoklu Yıldız Cırcır Anahtar (mm)
Multi-Star Wrenches

Krom vanadyum, Krom kaplı
Chrom vanadium, Chrom plated

KOD CODE	ÖLÇÜ SIZE	g	TL/Ad.
0335 02 0010	10x13x17x19	230	5 110,53

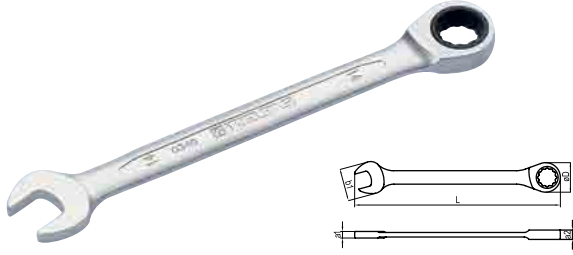

0340
Cırcır Kombine Anahtar (mm)
Combination Wrench With Ratchet (mm)

Krom vanadyum, Krom kaplı
Chrom vanadium, Chrom plated

KOD CODE	mm	L mm	a1 mm	a2 mm	b1 mm	σD mm	g	TL/Ad.
0340 02 0008	8	140	3.9	6.5	16.7	16.9	30	10 32,01
0340 02 0009	9	150	4.3	6.9	18.7	18.6	35	10 32,01
0340 02 0010	10	160	4.6	7.3	20.7	20.5	50	10 33,01
0340 02 0011	11	165	5.2	7.7	22.8	22.2	60	10 33,22
0340 02 0012	12	170	5.4	8.2	24.9	23.2	70	10 35,99
0340 02 0013	13	180	5.5	8.7	26.9	25	85	10 38,61
0340 02 0014	14	190	6	9	29.3	27.6	105	10 39,75
0340 02 0015	15	200	6.5	9.5	31.2	28.8	120	10 42,11
0340 02 0016	16	210	7.3	9.9	33.1	30.4	145	10 48,25
0340 02 0017	17	225	7.7	10.4	35.2	32.2	165	10 51,11
0340 02 0018	18	235	7.9	10.8	37.5	33.1	195	10 55,40
0340 02 0019	19	245	8.2	11.3	39.5	34.6	225	10 58,89
0340 02 0021	21	290	8.5	13	45.2	40.3	330	10 81,93
0340 02 0022	22	290	8.7	13.1	45.6	40.3	325	10 89,89
0340 02 0024	24	325	9.7	14.6	51.5	46.3	475	5 101,60

0340
Cırcır Kombine Anahtar Takımı (mm)
Combination Wrench With Ratchet, Set (mm)

KOD CODE	İÇERİK CONTENTS	g	TL/Ad.
0340 00 2108	8 - 9 - 10 - 11 12 - 13 - 17 - 19	720	8 314,85
0340 00 2112	8 - 9 - 10 - 11 12 - 13 - 14 - 15 16 - 17 - 18 - 19	1315	12 500,36
0340 00 2115	8 - 9 - 10 - 11 - 12 - 13 14 - 15 - 16 - 17 - 18 19 - 21 - 22 - 24	2445	15 773,78

0345
Mafsallı Cırcır Kombine Anahtar (mm)
Flexible Head Combination Wrench With Ratchet (mm)

Krom vanadyum, Krom kaplı
Chrom vanadium, Chrom plated

KOD CODE	mm	L mm	a1 mm	a2 mm	b mm	σD mm	g	TL/Ad.
0345 02 0008	8	127	4.3	6.5	16.2	16.7	35	10 44,98
0345 02 0009	9	131.5	4.6	6.9	18.2	18.6	40	10 45,83
0345 02 0010	10	136	5	7.3	20.3	20	55	10 47,72
0345 02 0011	11	141	5.4	7.7	22.5	21.8	65	10 49,19
0345 02 0012	12	147.5	5.8	8.2	24.3	23	80	10 52,01
0345 02 0013	13	154	6.1	8.6	26.8	25.2	90	10 54,25
0345 02 0014	14	160	6.4	9	28.7	26.8	110	10 57,05
0345 02 0015	15	169	6.9	9.4	30.5	28.3	130	10 59,86
0345 02 0016	16	179	7.2	9.9	32.9	29.8	150	10 65,14
0345 02 0017	17	190	7.6	10.3	34.5	31.8	175	10 66,02
0345 02 0018	18	200	8	10.8	37.2	32.6	195	10 71,08
0345 02 0019	19	215	8.6	11.2	39.2	33.9	240	10 74,27

0345
Mafsallı Cırcır Kombine Anahtar Takımı (mm)
Flexible Head Combination Wrench With Ratchet, Set (mm)

KOD CODE	İÇERİK CONTENTS	g	TL/Ad.
0345 00 2112	8 - 9 - 10 - 11 - 12 - 13 14 - 15 - 16 - 17 - 18 - 19	1365	12 687,40

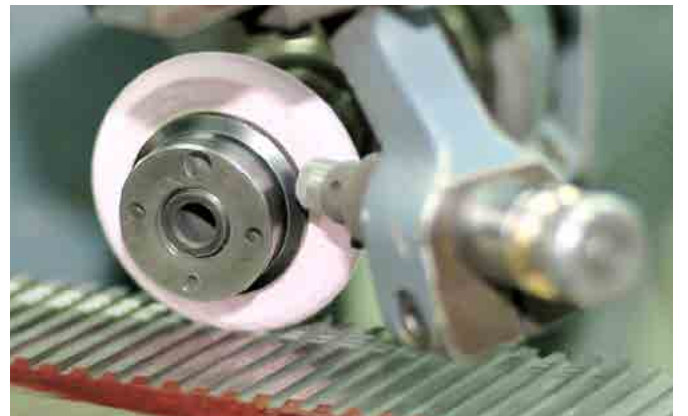

0360

XL Ekstra Uzun Kombine Anahtar (mm) Extra Long (XL) Combination Wrench (mm)

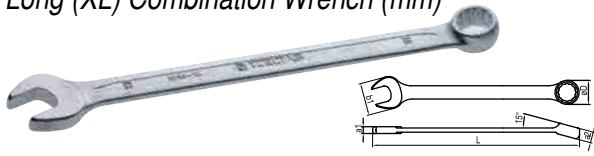

Krom vanadyum, Krom kaplı
Chrom vanadium, Chrom plated

KOD CODE	mm	L mm	a1 mm	a2 mm	b1 mm	øD mm	g	TL/Ad.
0360 02 0008	8	170	4.5	7.5	20.3	13.2	45	10, 14,28
0360 02 0009	9	180	4.5	8	22.4	14.6	55	10, 14,47
0360 02 0010	10	190	5	8.5	24.4	16	60	10, 16,07
0360 02 0011	11	200	5.5	9	26.4	17.2	75	10, 16,96
0360 02 0012	12	210	6	9.5	28.4	19	90	10, 16,96
0360 02 0013	13	225	6.5	10	30.5	20	110	10, 19,13
0360 02 0014	14	235	7	11	32.5	21.8	120	10, 19,87
0360 02 0015	15	250	7.5	12	34.5	23	150	10, 21,15
0360 02 0016	16	265	8	13	36.4	24.5	175	10, 21,48
0360 02 0017	17	280	8.5	14	38.4	26.5	210	10, 24,34
0360 02 0018	18	295	9	15	40.6	28	240	10, 26,38
0360 02 0019	19	310	9.5	16	42.6	29.5	280	10, 28,58
0360 02 0020	20	310	9.5	16	44.5	31	265	10, ---
0360 02 0021	21	340	10	17	46.6	33	370	10, 32,44
0360 02 0022	22	350	11	18	48.7	34.5	410	10, 38,52
0360 02 0023	23	350	11	18	50.7	35.7	400	5, ---
0360 02 0024	24	400	12	19	52.7	37.5	535	5, 47,14
0360 02 0025	25	400	12	19	54.6	38.5	510	5, ---
0360 02 0026	26	450	13	20	56.7	41	700	5, ---
0360 02 0027	27	450	13	20	58.9	42	680	5, 55,52
0360 02 0028	28	450	13	20	60.1	43.5	660	5, ---
0360 02 0029	29	480	14	21	62.5	45.5	890	5, ---
0360 02 0030	30	480	14	21	64.8	47	870	1, 63,73
0360 02 0032	32	500	15	22	67	49.5	1000	1, 66,86
0360 02 0034	34	520	15	23	70	53	1100	1, 68,19
0360 02 0036	36	550	16	24	73	57.2	1320	1, 77,28
0360 02 0038	38	575	16	25	76	58.5	1500	1, ---
0360 02 0041	41	600	16	26	86	63.5	1700	1, 90,01
0360 02 0046	46	640	17.4	27	96	70.9	2230	1, 104,89

0360

XL Ekstra Uzun Kombine Anahtar Takımı (mm) Extra Long (XL) Combination Wrench, Set (mm)



KOD CODE	İÇERİK CONTENTS	g	TL/Ad.
0360 00 2108	8 - 9 - 10 - 11 - 12 - 13 - 17 - 19	915	8, 150,79
0360 00 2110	8 - 9 - 10 - 11 - 12 13 - 14 - 17 - 19 - 22	1450	10, 209,18
0360 00 2112	8 - 9 - 10 - 11 - 12 - 13 - 14 15 - 16 - 17 - 19 - 22	1775	12, 251,81
0360 00 2117	8 - 9 - 10 - 11 - 12 - 13 - 14 - 15 - 16 17 - 18 - 19 - 20 - 21 - 22 - 24 - 27	3876	17, -----

0370

Boyunlu Kombine Anahtar (mm) Offset Combination Wrench (mm)

TS 3794 • DIN 3113

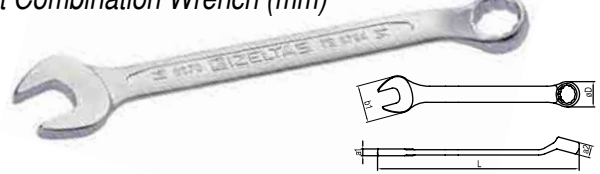

Krom vanadyum, Krom kaplı
Chrom vanadium, Chrom plated

KOD CODE	mm	L mm	a1 mm	a2 mm	b1 mm	øD mm	g	TL/Ad.
0370 02 0006	6	110	3.8	5.6	16	10.4	20	10, 10,02
0370 02 0007	7	120	4	6.2	18	11.8	25	10, 10,66
0370 02 0008	8	130	4.2	6.7	20	13.2	30	10, 11,59
0370 02 0009	9	140	4.4	7.3	22	14.6	35	10, 11,89
0370 02 0010	10	150	4.6	7.8	24	16	40	10, 13,46
0370 02 0011	11	160	4.8	8.4	26	17.2	50	10, 13,84
0370 02 0012	12	167	5	9	28	18.7	65	10, 14,75
0370 02 0013	13	175	5.4	9.6	30	20	75	10, 15,05
0370 02 0014	14	185	5.8	10.2	32	21.7	90	10, 16,29
0370 02 0015	15	195	6.2	10.8	34	23	105	10, 17,41
0370 02 0016	16	210	6.6	11.4	36	24.5	120	10, 18,68
0370 02 0017	17	225	7	12	38	26	160	10, 19,98
0370 02 0018	18	237	7.4	12.4	40	27.5	170	10, 22,31
0370 02 0019	19	250	7.8	13	42	29	200	10, 23,45
0370 02 0020	20	267	8.2	13.2	44	30.5	230	10, 23,85
0370 02 0021	21	283	8.6	13.8	46	32	265	10, 27,74
0370 02 0022	22	295	9	14.6	48	35	300	10, 31,78
0370 02 0023	23	295	9	14.6	48	35	300	5, 38,86
0370 02 0024	24	329	9.4	15.4	52	38	380	5, 38,86
0370 02 0025	25	329	9.4	15.4	52	38	380	5, 38,86
0370 02 0026	26	360	10.2	16.8	58	41.5	485	5, 45,77
0370 02 0027	27	360	10.2	16.8	58	41.5	475	5, 45,77
0370 02 0028	28	360	10.2	16.8	58	41.5	470	5, 45,77
0370 02 0029	29	394	11	18.2	64	44.5	610	5, 52,62
0370 02 0030	30	394	11	18.2	64	44.5	620	5, 52,62
0370 02 0032	32	435	11.8	19.7	66	47.5	765	5, 55,14
0370 02 0036	36	468	12.6	21.2	76	53	1020	5, 63,73

0370

Boyunlu Kombine Anahtar Takımı (mm) Offset Combination Wrench, Set (mm)



KOD CODE	İÇERİK CONTENTS	g	TL/Ad.
0370 00 2106	8 - 9 - 11 - 13 - 17 - 19	615	6, 95,80
0370 00 2108	6 - 7 - 8 - 9 - 10 - 13 - 17 - 19	665	8, 116,10
0370 00 2110	8 - 9 - 10 - 11 - 12 - 13 - 14 - 17 - 19 - 22	1200	10, 172,08
0370 00 2112	8 - 9 - 10 - 11 - 12 - 13 - 14 15 - 16 - 17 - 19 - 22	1375	12, 208,17
0370 00 2117	6 - 7 - 8 - 9 - 10 - 11 - 12 - 13 - 14 15 - 16 - 17 - 18 - 19 - 20 - 21 - 22	2100	17, 302,75
0370 00 2121	6 - 7 - 8 - 9 - 10 - 11 - 12 - 13 - 14 - 15 16 - 17 - 18 - 19 - 20 - 21 - 22 - 24 - 27 30 - 32	4425	21, 495,14

0380

Torx® - mm Kombine Anahtar
Torx® - mm Combination Wrench

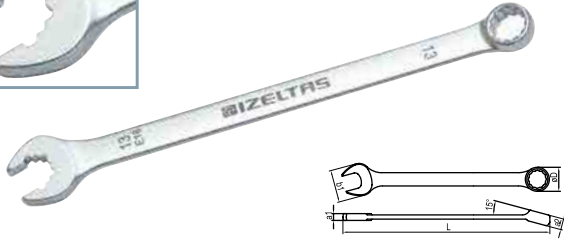

Krom vanadyum, Krom kaplı
Chrom vanadium, Chrom plated

KOD CODE	mm	☆	L mm	a1 mm	a2 mm	b1 mm	øD mm	g	□	TL/Ad.
0380 02 0008	8	E10	130	4.5	7.5	20.3	13.2	35	10	
0380 02 0009	9	E12	141	4.5	8	22.4	14.6	45	10	
0380 02 0010	10	E14	154	5	8.5	24.4	16	55	10	
0380 02 0011	11	E14	166	5.5	9	26.4	17.2	65	10	
0380 02 0012	12	E16	178	6	9.5	28.4	19	80	10	
0380 02 0013	13	E18	190	6.5	10	30.5	20	90	10	
0380 02 0014	14	E18	203	7	11	32.5	21.8	110	10	
0380 02 0015	15	E20	215	7.5	12	34.5	23	130	10	
0380 02 0017	17	E22	239	8.5	14	38.4	26.5	180	10	
0380 02 0018	18	E24	350	9	15	40.6	28	210	10	
0380 02 0019	19	E24	263	9.5	16	42.6	29.5	240	10	
0380 02 0022	22	E26	300	11	18	48.7	34.5	350	10	

0380

Torx® - mm Kombine Anahtar Takımı
Torx® - mm Combination Wrench Set



KOD CODE	İÇERİK CONTENTS	g	□	TL/Ad.
0380 00 2106	8 - 9 - 11 - 13 - 17 - 19	655	6	
0380 00 2108	8 - 9 - 10 - 11-12-13 - 17 - 19	790	8	
0380 00 2110	8 - 9 - 10 - 11 - 12 - 13 - 14 17 - 19 - 22	1250	10	
0380 00 2112	8 - 9 - 10 - 11 - 12 - 13 - 14 - 15 - 17 - 18 - 19 - 22	1590	12	

0430

Yıldız İki Ağız Anahtar (mm)
Double Ended Ring Wrench (mm)



TS 3794 • DIN 838

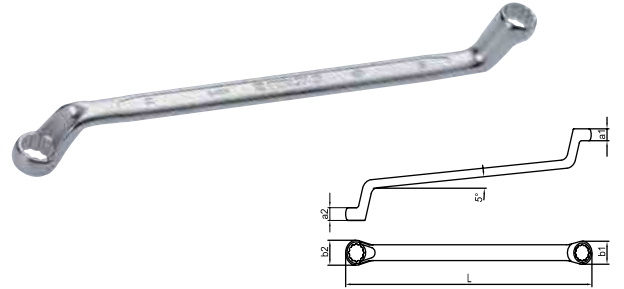

Krom vanadyum, Krom kaplı
Chrom vanadium, Chrom plated

KOD CODE	mm	L mm	a1 mm	a2 mm	b1 mm	b2 mm	g	□	TL/Ad.
0430 03 0607	6x7	176	5.6	6	10	11.5	55	10	15,92
0430 03 0809	8x9	190	6.4	6.8	13	14.5	75	10	16,12
0430 03 0810	8x10	190	6.4	7.3	13	15.5	70	10	16,12
0430 03 1011	10x11	206	7.3	7.6	15.5	17	105	10	17,92
0430 03 1012	10x12	206	7.3	8.5	15.5	18.5	105	10	17,92
0430 03 1013	10x13	220	7.3	9	15.5	20	120	10	----
0430 03 1014	10x14	220	7.3	9.5	15.5	21.5	120	10	----
0430 03 1113	11x13	220	7.6	9	17	20	130	10	20,28
0430 03 1213	12x13	220	8.5	9	18.5	20	135	10	20,28
0430 03 1214	12x14	220	8.5	9.5	18.5	21.5	145	10	20,28
0430 03 1315	13x15	236	9	10	20	23	170	10	----
0430 03 1415	14x15	236	9.5	10	21.5	23	180	10	21,31
0430 03 1317	13x17	250	9	11.5	20	26.5	215	10	24,16
0430 03 1417	14x17	250	9.5	11.5	21.5	26.5	210	10	24,16
0430 03 1617	16x17	250	10.8	11.5	25	26.5	220	10	24,16
0430 03 1618	16x18	250	10.8	12	25	27.5	210	10	28,84
0430 03 1719	17x19	271	11.5	12.5	26.5	29	270	10	28,84
0430 03 1819	18x19	271	12	12.5	27.5	29	270	10	28,84
0430 03 1922	19x22	291	12.5	13.5	29	33	330	5	31,59
0430 03 1924	19x24	311	12.5	14.2	29	36.5	345	5	31,59
0430 03 2022	20x22	291	12.9	13.5	30.5	33	330	5	31,59
0430 03 2123	21x23	311	13.1	14	32	35	410	5	36,28
0430 03 2224	22x24	321	13.5	14.2	33	36.5	410	5	36,28
0430 03 2227	22x27	331	14.2	15	36.5	40.5	500	5	----
0430 03 2426	24x26	331	14.2	14.6	36.5	39.5	495	5	42,24
0430 03 2427	24x27	331	14.2	15	36.5	40.5	495	5	42,24
0430 03 2430	24x30	352	14.2	16.7	36.5	40	530	5	46,27
0430 03 2528	25x28	352	14.5	15.5	38	42.5	550	5	46,27
0430 03 2729	27x29	371	15	16.7	40.5	45	660	5	50,91
0430 03 2730	27x30	371	15	16.7	40.5	45	660	5	50,91
0430 03 2732	27x32	371	15	16.7	40.5	47.5	660	5	50,91
0430 03 3032	30x32	371	16.4	16.7	45	47.5	660	5	50,91
0430 03 3034	30x34	379	16.4	16.9	45	50	690	5	----
0430 03 3036	30x36	402	16.4	17.5	45	53	880	5	78,60
0430 03 3236	32x36	402	16.7	17.5	47.5	53	890	5	78,60
0430 03 3436	34x36	420	17.1	17.5	50	53	1000	5	96,06
0430 03 3641	36x41	438	17.5	19.5	53	61	1150	5	106,81
0430 03 4146	41x46	485	19.5	20.5	61	67.5	1430	5	146,41
0430 03 4650	46x50	535	20.5	22.4	67.5	73.5	1960	5	233,00

0430

Yıldız İki Ağz Anahtar Takımı (mm) Double Ended Ring Wrench Set (mm)



KOD CODE	İÇERİK CONTENTS	g	TL/Ad.
0430 00 2106	6x7 - 8x9 - 10x11 12x13 - 14x15 - 16x17	820	6 115,71
0430 00 2108	6x7 - 8x9 - 10x11 - 12x13 - 14x15 16x17 - 18x19 - 20x22	1450	8 176,14
0430 00 2110	6x7 - 8x9 - 10x11 - 12x13 - 14x15 16x17 18x19 - 20x22 - 21x23-24x26	2405	10 254,66
0430 00 2112	6x7 - 8x9 - 10x11 - 12x13 - 14x15 16x17 - 18x19 - 20x22 - 21x23 24x26 - 25x28 - 27x32	3610	12 351,84

0431

Yıldız İki Ağz Anahtar (SAE) Double Ended Ring Wrench (SAE)

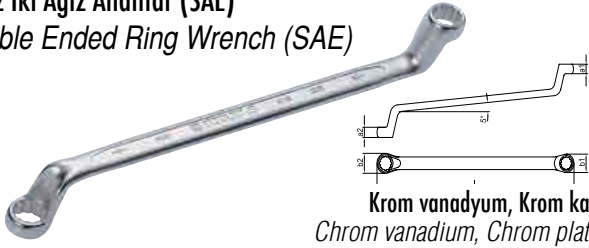

Krom vanadyum, Krom kaplı
Chrom vanadium, Chrom plated

KOD CODE	inch	L mm	a1 mm	a2 mm	b1 mm	b2 mm	g	TL/Ad.
0431 03 0608	1/4"x5/16"	176	5.6	6	10	11.5	55	10 20,66
0431 03 0809	5/16"x3/8"	190	6.4	6.8	13	14.5	75	10 21,46
0431 03 0811	5/16"x7/16"	190	6.4	7.3	13	15.5	115	10 22,52
0431 03 0911	3/8"x7/16"	206	7.3	7.6	15.5	17	115	10 23,67
0431 03 1112	7/16"x1/2"	220	8.5	9	18.5	20	135	10 24,34
0431 03 1214	1/2"x9/16"	220	8.5	9.5	18.5	21.5	145	10 25,67
0431 03 1415	9/16"x19/32"	236	9.5	10	21.5	23	165	10 25,67
0431 03 1416	9/16"x5/8"	236	9.5	10	21.5	23	165	10 27,20
0431 03 1217	1/2"x11/16"	250	9	10	20	26.5	185	10 ---
0431 03 1417	9/16"x11/16"	250	9.5	11.5	21.5	26.5	185	10 ---
0431 03 1517	19/32"x11/16"	250	10.8	11.5	25	26.5	210	10 29,21
0431 03 1617	5/8"x11/16"	250	10.8	11.5	25	26.5	210	10 ---
0431 03 1619	5/8"x3/4"	271	11.5	12.5	26.5	29	270	10 ---
0431 03 1920	3/4"x25/32"	271	12	12.5	27.5	29	270	10 37,91
0431 03 2021	25/32"x13/16"	291	12.9	13.5	30.5	33	270	5 ---
0431 03 1922	3/4"x7/8"	291	12.9	13.5	30.5	33	400	5 ---
0431 03 2122	13/16"x7/8"	311	13.1	14	32	35	400	5 39,85
0431 03 2223	7/8"x15/16"	321	13.5	14.2	33	36.5	400	5 ---
0431 03 2325	15/16"x1"	331	14.2	14.6	36.5	39.5	495	5 52,90
0431 03 2328	15/16"x1 1/8"	331	14.2	15	36.5	40.5	500	5 ---
0431 03 2528	1"x1 1/8"	352	14.5	15.5	38	42.5	570	5 ---
0431 03 2631	1 1/16"x1 1/4"	371	15	16.7	40.5	48	640	5 63,25
0431 03 2833	1 1/8"x1 5/16"	371	15	16.7	40.5	48	660	5 63,25
0431 03 3033	1 3/16"x1 5/16"	371	16.4	16.7	45	48	670	5 68,46
0431 03 3036	1 3/16"x1 3/8"	402	16.4	17.5	45	53	880	5 ---
0431 03 3236	1 1/4"x1 7/16"	402	16.7	17.5	48	53	890	5 ---
0431 03 3641	1 7/16"x1 5/8"	438	17.5	19.5	53	61	1100	5 ---
0431 03 4146	1 11/16"x1 7/8"	485	19.5	20.5	61	67.5	1390	5 ---
0431 03 4650	1 13/16"x2"	535	20.5	22.5	67.5	73.5	1955	5 ---

0431

Yıldız İki Ağz Anahtar Takımı (SAE) Double Ended Ring Wrench, Set (SAE)



KOD CODE	İÇERİK CONTENTS	g	TL/Ad.
0431 00 2106	3/8"x7/16" - 9/16"x5/8" 19/32"x11/16" 3/4"x25/32" - 13/16"x7/8" 15/16"x1"	1780	6 210,74
0431 00 2108	1/4"x5/16" - 5/16"x3/8" 7/16"x1/2" - 9/16"x5/8" 19/32"x11/16" 3/4"x25/32" - 13/16"x7/8" 15/16"x1"	1915	8 253,53
0431 00 2110	1/4"x5/16" - 5/16"x3/8" 7/16"x1/2" - 9/16"x5/8" 19/32"x11/16" 3/4"x25/32" - 13/16"x7/8" 15/16"x 1" - 1 1/16"x1 1/4" 1 1/8"x1 5/16"	3275	10 380,03
0431 00 2112	1/4"x5/16" - 5/16"x3/8" 3/8"x7/16" - 7/16"x1/2" 9/16"x5/8" - 19/32"x11/16" 3/4"x25/32" - 1 3/16"x7/8" 15/16"x 1" - 1 1/16"x1 1/4" 1 1/8"x1 5/16" 1 3/16"x1 5/16"	3985	12 472,16

0432

Yıldız İki Ağz Anahtar MASTER (mm) Double Ended Ring Wrench (mm) MASTER



TS 3794 • DIN 838

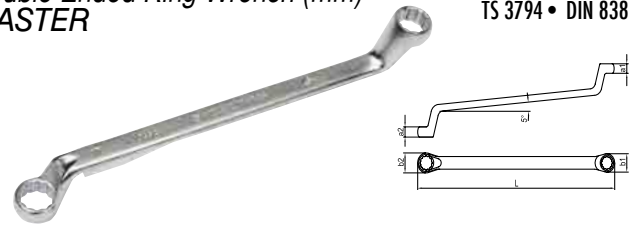

Saten krom yüzeyli, Krom vanadyum, Krom kaplı
Satin chrom finish, Chrom vanadium, Chrom plated

KOD CODE	mm	L mm	a1 mm	a2 mm	b1 mm	b2 mm	g	TL/Ad.
0432 03 0607	6x7	176	5.6	6	10	11.5	55	10 17,51
0432 03 0809	8x9	190	6.4	6.8	13	14.5	75	10 17,74
0432 03 1011	10x11	206	7.3	7.6	15.5	17	105	10 19,72
0432 03 1213	12x13	220	8.5	9	18.5	20	135	10 22,31
0432 03 1415	14x15	236	9.5	10	21.5	23	180	10 23,45
0432 03 1617	16x17	250	10.8	11.5	25	26.5	220	10 26,57
0432 03 1719	17x19	271	11.5	12.5	26.5	29	270	10 31,75
0432 03 1819	18x19	271	12	12.5	27.5	29	270	10 31,75
0432 03 2022	20x22	291	12.9	13.5	30.5	33	330	5 34,75
0432 03 2123	21x23	311	13.1	14	32	35	410	5 39,91
0432 03 2426	24x26	331	14.2	14.6	36.5	39.5	495	5 46,46
0432 03 2528	25x28	352	14.5	15.5	38	42.5	550	5 50,91
0432 03 2732	27x32	371	15	16.7	40.5	47.5	660	5 56,00

0432
Yıldız İki Ağız Anahtar Takımı MASTER (mm)
Double Ended Ring Wrench Set MASTER (mm)



KOD CODE	İÇERİK CONTENTS	g		TL/Ad.
0432 00 2106	6x7 - 8x9 - 10x11 12x13 - 14x15 - 16x17	820	6	-----
0432 00 2108	6x7 - 8x9 - 10x11 12x13 - 14x15 - 16x17 18x19 - 20x22	1450	8	-----
0432 00 2110	6x7 - 8x9 - 10x11 12x13 - 14x15 - 16x17 18x19 - 20x22 - 21x23 24x26	2405	10	-----
0432 00 2112	6x7 - 8x9 - 10x11 12x13 - 14x15 - 16x17 18x19 - 20x22 - 21x23 24x26 - 25x28 - 27x32	3610	12	387,08

0435
Süper İzoleli Bir Ağız Yıldız Anahtar (mm)
Single Ended Ring Wrench Super
Insulated (mm)

Krom vanadyum, Krom kaplı, PVC izoleli
Chrom vanadium, Chrom plated, PVC insulated

KOD CODE	mm	L mm	g		TL/Ad.
0435 03 0010	10	170	100	10	22,39
0435 03 0011	11	180	110	10	22,39
0435 03 0012	12	190	130	10	25,37
0435 03 0013	13	200	150	10	25,37
0435 03 0014	14	215	180	10	26,64
0435 03 0017	17	230	220	10	30,20
0435 03 0019	19	245	270	10	36,06
0435 03 0022	22	260	310	10	39,49
0435 03 0024	24	280	420	10	52,80

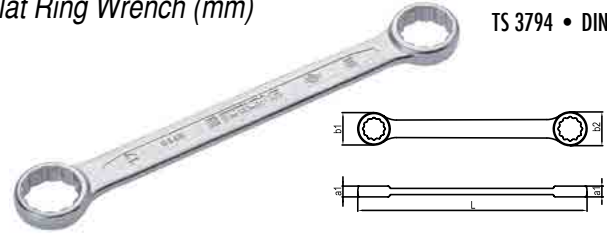
0440
Düz Yıldız Anahtar (mm)
Flat Ring Wrench (mm)

TS 3794 • DIN 837

Krom vanadyum, Krom kaplı
Chrom vanadium, Chrom plated

KOD CODE	mm	L mm	a1 mm	b1 mm	b2 mm	g		TL/Ad.
0440 03 0607	6x7	99	4.4	9.5	11	10	10	14,66
0440 03 0809	8x9	113	5.2	12.5	14	25	10	15,26
0440 03 0810	8x10	120	5.6	12.5	15.5	30	10	----
0440 03 1011	10x11	125	6	15.5	16.5	30	10	16,96
0440 03 1013	10x13	140	6.6	15.5	20	45	10	----
0440 03 1213	12x13	140	6.8	18.5	20	45	10	18,29
0440 03 1315	13x15	156	7.2	20	22.5	55	10	----
0440 03 1415	14x15	156	7.2	21	22.5	60	10	21,31
0440 03 1317	13x17	170	8	20	25	85	10	----
0440 03 1617	16x17	170	8	24	25	80	10	25,31
0440 03 1618	16x18	175	8.6	24	26.5	90	10	----
0440 03 1719	17x19	188	8.8	25	27.5	105	10	----
0440 03 1819	18x19	188	8.8	26.5	27.5	105	10	26,50
0440 03 2022	20x22	208	9.6	29	32	135	10	30,82
0440 03 2123	21x23	230	10.6	30	33	170	10	36,49
0440 03 2224	22x24	230	10.8	32	35	170	10	----
0440 03 2426	24x26	256	10.8	35	37.5	225	10	36,93
0440 03 2427	24x27	256	10.8	35	38.5	225	10	----
0440 03 2528	25x28	280	11.8	36	40.5	270	10	43,15
0440 03 2729	27x29	290	12.8	38.5	42.5	285	10	----
0440 03 2732	27x32	310	12.8	38.5	45.5	355	10	53,39
0440 03 3032	30x32	310	12.8	43	45.5	360	10	----

0440
Düz Yıldız Anahtar Takımı (mm)
Flat Ring Wrench, Set (mm)

KOD CODE	İÇERİK CONTENTS	g		TL/Ad.
0440 00 2106	6x7 - 8x9 - 10x11 - 12x13 14x15 - 16x17	315	6	111,79
0440 00 2108	6x7 - 8x9 - 10x11 - 12x13 - 14x15 16x17 - 18x19 - 20x22	560	8	169,11
0440 00 2110	6x7 - 8x9 - 10x11 - 12x13 - 14x15 16x17 18x19 - 20x22 - 21x23 24x26	895	10	242,53
0440 00 2112	6x7 - 8x9 - 10x11 - 12x13 - 14x15 16x17 - 18x19 - 20x22 - 21x23 24x26 - 25x28 - 27x32	1540	12	339,07

0530

Yarım Ay Anahtar Yıldız İki Ağzı (mm)
Double - Hex Starter and Block Wrench (mm)

TSEK

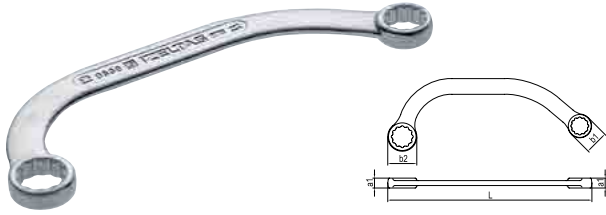

Krom vanadyum, Krom kaplı
Chrom vanadium, Chrom plated

KOD CODE	mm	L mm	a1 mm	b1 mm	b2 mm	g		TL/Ad.
0530 04 0810	8x10	120	6	12.5	15.5	30	10	22,83
0530 04 1011	10x11	150	7	17	20	55	10	----
0530 04 1012	10x12	150	7	17	20	55	10	26,85
0530 04 1113	11x13	150	7	17	20	55	10	26,85
0530 04 1315	13x15	185	9	21.5	26	110	10	32,07
0530 04 1317	13x17	185	9	21.5	26	105	10	32,07
0530 04 1417	14x17	185	9	21.5	26	110	10	32,07
0530 04 1517	15x17	185	9	21.5	26	100	10	32,07
0530 04 1922	19x22	230	11	29	33	195	10	41,67

0531

Yarım Ay Anahtar Yıldız İki Ağzı (SAE)
Double - Hex Starter and Block Wrench (SAE)

TSEK

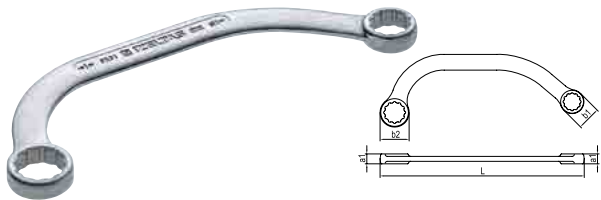

Krom vanadyum, Krom kaplı
Chrom vanadium, Chrom plated

KOD CODE	inch	L mm	a1 mm	b1 mm	b2 mm	g		TL/Ad.
0531 04 0809	5/16"x3/8"	120	6	12.5	15.5	30	10	----
0531 04 0911	3/8"x7/16"	150	7	17	20	50	10	----
0531 04 1112	7/16"x1/2"	150	7	17	20	50	10	34,83
0531 04 1214	1/2"x9/16"	185	9	21.5	26	110	10	38,27
0531 04 1416	9/16"x5/8"	185	9	21.5	26	115	10	41,71
0531 04 1417	9/16"x11/16"	185	9	21.5	26	110	10	----
0531 04 1517	9/32"x11/16"	185	9	21.5	26	105	10	----
0531 04 1922	3/4"x7/8"	230	11	29	33	195	10	50,86



0540

Rekor Anahtar (mm)
Flarenut Wrench (mm)

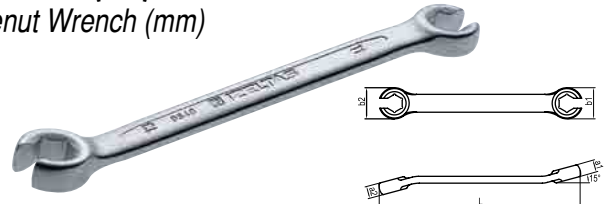

Krom vanadyum, Krom kaplı
Chrom vanadium, Chrom plated

KOD CODE	mm	L mm	a1 mm	a2 mm	b1 mm	b2 mm	g		TL/Ad.
0540 01 0810	8x10	130	7	8.5	18	20	60	10	29,98
0540 01 1011	10x11	150	8.5	9.3	20	22	75	10	31,10
0540 01 1012	10x12	150	8.5	9.3	20	22	75	10	31,10
0540 01 1113	11x13	170	9.3	10.8	22	25.5	105	10	33,32
0540 01 1214	12x14	170	9.3	10.8	22	25.5	105	10	33,32
0540 01 1417	14x17	190	10.8	11.8	25	30.5	140	10	----
0540 01 1719	17x19	210	11.8	13	30.5	33.5	185	10	48,17
0540 01 1922	19x22	230	12.8	14.9	33.5	39.5	235	10	57,76

0550

Boru Uzatmalı Yıldız Anahtar (mm)
Offset Ring Wrench (mm)

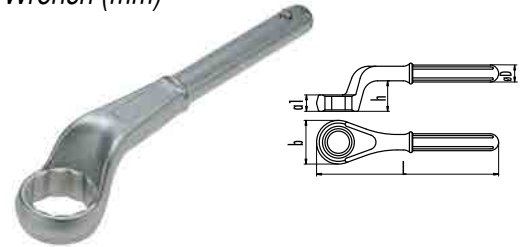

Krom vanadyum, Krom kaplı
Chrom vanadium, Chrom plated

KOD CODE	mm	L mm	a1 mm	b mm	øD mm	h mm	g		TL/Ad.
0550 05 0022	22	180	17	37	18.5	30	400	1	----
0550 05 0024	24	180	17	37	18.5	30	400	1	63,83
0550 05 0027	27	190	18	42	18.5	33	450	1	76,14
0550 05 0030	30	200	20	46	18.5	34	520	1	90,99
0550 05 0032	32	235	21.5	49	21.2	37	700	1	104,46
0550 05 0034	34	235	21.5	49	21.2	37	750	1	----
0550 05 0036	36	245	23	53.5	21.2	42	830	1	118,23
0550 05 0038	38	270	25	60.5	21.2	42	965	1	136,41
0550 05 0041	41	270	25	60.5	21.2	43	950	1	154,62
0550 05 0046	46	280	26	68	24.2	45	1240	1	184,91
0550 05 0050	50	290	28	74	24.2	47	1410	1	218,43
0550 05 0055	55	300	30	79	24.2	50	1550	1	307,24
0550 05 0060	60	345	32	89	29	50.5	2390	1	333,45
0550 05 0065	65	355	35	98	29	53	2730	1	361,01
0550 05 0070	70	365	37	104	29	55	2900	1	----
0550 05 0075	75	375	40	109	29	57.5	3100	1	----
0550 05 0080	80	385	43	124	29	59	3900	1	----
0550 05 0085	85	385	43	124	29	59	3750	1	----
0550 05 0090	90	410	46	140	29	63	5100	1	----
0550 05 0095	95	410	46	140	29	63	4950	1	----
0550 05 0100	100	420	46	150	29	65	4800	1	----

0551
Döndürme Kolu Borusu
Tubular Handle

Krom vanadyum, Krom kaplı
Chrom vanadium, Chrom plated

KOD CODE	mm	L mm	Ø mm	g		TL/Ad.
0551 05 0001	22 - 30	460	19	700	1	49,34
0551 05 0002	32 - 41	610	22	1220	1	66,89
0551 05 0003	46 - 55	760	25	1880	1	100,30
0551 05 0004	60 - 100	860	30	2975	1	135,40

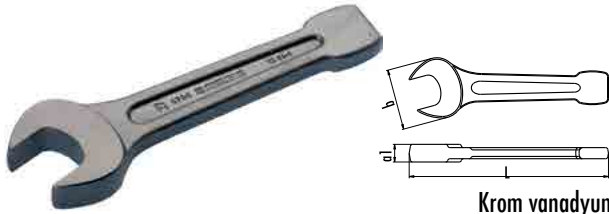
0700
Çatal Çakma Anahtar (mm)
Slugging Open Jaw Wrench (mm)

TS 81 • DIN 133
Krom vanadyum
Chrom vanadium

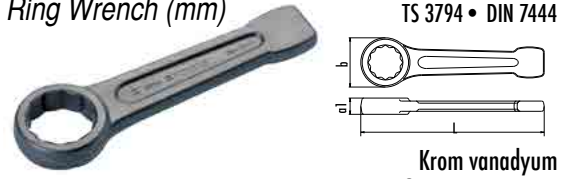
KOD CODE	mm	L mm	a1 mm	b mm	g		TL/Ad.
0700 05 0024	24	160	15	42	280	1	37,92
0700 05 0027	27	180	16	45	385	1	47,11
0700 05 0030	30	190	17	50	525	1	57,86
0700 05 0032	32	190	17	50	530	1	64,96
0700 05 0036	36	205	19	58	755	1	72,99
0700 05 0038	38	205	19	58	760	1	87,82
0700 05 0041	41	225	20	62	920	1	95,38
0700 05 0042	42	225	20	62	930	1	110,21
0700 05 0046	46	240	22	72	1305	1	121,33
0700 05 0047	47	240	22	72	1320	1	141,71
0700 05 0050	50	255	23	78	1565	1	151,60
0700 05 0055	55	272	25	88	2305	1	203,29
0700 05 0060	60	272	25	88	2310	1	220,63
0700 05 0065	65	300	28	98	3300	1	317,47
0700 05 0070	70	330	32	108	4555	1	406,44
0700 05 0075	75	330	32	108	4460	1	430,63
0700 05 0080	80	360	35	126	6115	1	547,65
0700 05 0085	85	360	35	126	5740	1	726,07
0700 05 0090	90	390	40	140	8040	1	747,01
0700 05 0095	95	390	40	140	8160	1	796,59
0700 05 0100	100	420	44	148	12355	1	1129,14
0700 05 0105	105	420	44	148	11785	1	1164,27
0700 05 0110	110	450	48	166	15000	1	1328,58
0700 05 0115	115	450	48	166	14830	1	1526,20
0700 05 0120	120	490	54	178	18865	1	1610,96
0700 05 0125	125	490	54	178	17250	1	-----
0700 05 0130	130	518	59	196	20000	1	-----
0700 05 0135	135	518	59	196	19700	1	-----
0700 05 0140	140	518	59	196	19400	1	-----
0700 05 0145	145	580	62	223	28000	1	-----
0700 05 0150	150	580	62	223	27600	1	-----

0750
Yıldız Çakma Anahtar (mm)
Slugging Ring Wrench (mm)

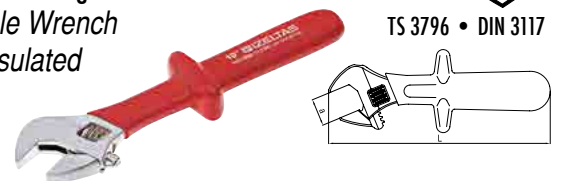
TS 3794 • DIN 7444
Krom vanadyum
Chrom vanadium

KOD CODE	mm	L mm	a1 mm	b mm	g		TL/Ad.
0750 05 0024	24	160	15	42	235	1	53,20
0750 05 0027	27	180	16	46	325	1	63,47
0750 05 0030	30	190	17	52	435	1	75,82
0750 05 0032	32	190	17	52	425	1	87,07
0750 05 0036	36	205	19	59	550	1	98,54
0750 05 0038	38	205	19	59	530	1	118,06
0750 05 0041	41	225	20	64	730	1	128,85
0750 05 0042	42	225	20	64	700	1	147,39
0750 05 0046	46	240	22	73	970	1	154,12
0750 05 0047	47	240	22	73	930	1	170,08
0750 05 0050	50	255	23	78	1160	1	182,03
0750 05 0055	55	272	25	88	1520	1	256,03
0750 05 0060	60	272	25	88	1460	1	277,86
0750 05 0065	65	300	28	100	2025	1	363,28
0750 05 0070	70	330	32	109	2890	1	415,91
0750 05 0075	75	330	32	109	2755	1	445,14
0750 05 0080	80	360	35	123	4000	1	632,34
0750 05 0085	85	360	35	123	3620	1	711,50
0750 05 0090	90	390	40	142	5465	1	875,24
0750 05 0095	95	390	40	142	5250	1	986,88
0750 05 0100	100	420	44	152	6755	1	1140,92
0750 05 0105	105	420	44	152	6445	1	1177,69
0750 05 0110	110	450	46	165	8500	1	1258,95
0750 05 0115	115	450	46	165	8460	1	1411,25
0750 05 0120	120	480	48	185	11425	1	1939,66
0750 05 0125	125	543	54	254	17250	1	-----
0750 05 0130	130	570	55	275	20000	1	-----
0750 05 0135	135	570	55	275	19700	1	-----
0750 05 0140	140	570	55	275	19400	1	-----
0750 05 0145	145	640	60	307	28000	1	-----
0750 05 0150	150	640	60	307	27600	1	-----
0750 05 0155	155					1	-----
0750 05 0165	165					1	-----
0750 05 0170	170					1	-----
0750 05 0180	180					1	-----

0600
Süper İzole Kurbağacık Anahtar
Adjustable Wrench
Super Insulated

TS 3796 • DIN 3117
Krom vanadyum, Krom kaplı, Kalın PVC izoleli
Chrom vanadium, Chrom plated, Double PVC insulated

KOD CODE	L mm	L inch	a mm	g		TL/Ad.
0600 01 0010	260	10"	28	480	5	93,38

0600

Kurbağacık Anahtar Adjustable Wrench



TS 3796 • DIN 3117

Krom vanadyum, Krom kaplı, PVC izoleli
Chrom vanadium, Chrom plated, PVC insulated

KOD CODE	L mm	L inch	a mm	g	TL/Ad.
0600 01 1006	160	6"	18	120	5 38,73
0600 01 1008	208	8"	23	230	5 57,11
0600 01 1010	260	10"	28	400	5 73,60
0600 01 1012	308	12"	34	670	5 101,84
0600 01 1015	388	15"	43	1555	1 159,61

0600

Somun Nut



KOD CODE	L mm	L inch	g	TL/Ad.
0600 01 0206	160	6"	5	10 3,63
0600 01 0208	208	8"	10	10 4,94
0600 01 0210	260	10"	10	10 6,66
0600 01 0212	308	12"	20	10 9,12
0600 01 0215	388	15"	65	10 13,20

0600

Vida Bolt



KOD CODE	L mm	L inch	g	TL/Ad.
0600 01 0306	160	6"	3	10 0,94
0600 01 0308	208	8"	5	10 1,54
0600 01 0310	260	10"	5	10 1,88
0600 01 0312	308	12"	10	10 2,56
0600 01 0315	388	15"	20	10 3,31

0600

Yay Spring



KOD CODE	L mm	L inch	g	TL/Ad.
0600 01 0406	160	6"	1	10 0,58
0600 01 0408	208	8"	1	10 0,58
0600 01 0410	260	10"	1	10 0,58
0600 01 0412	308	12"	1	10 0,58
0600 01 0415	388	15"	3	10 0,58

0600

Kurbağacık Anahtar Armatür Adjustable Wrench for Plumbers



TS 3796 • DIN 3117

Krom vanadyum, Krom kaplı, PVC izoleli
Chrom vanadium, Chrom plated, PVC insulated

KOD CODE	L mm	L inch	a mm	g	TL/Ad.
0600 01 2012	308	12"	34	660	5 118,32

0600

Kurbağacık Anahtar Sehpa (29 Parça) Adjustable Wrench Set (29 Pcs)



KOD CODE	İÇERİK CONTENTS	g	TL/Ad.
0600 00 6129	6" - 8" - 10" - 12" - 15"	16865	6 5 2506,23

0610

Armatür Anahtar Adjustable Wrench for Plumbers



KOD CODE	L mm	L inch	g	TL/Ad.
0610 01 0275	275	11"	715	5 198,92

0615

Ayarlı Montaj Anahtarı Adjustable, Speed Wrench



Krom vanadyum, Krom kaplı, PVC izoleli
Chrom vanadium, Chrom plated, PVC insulated

KOD CODE	L mm	L inch	a mm	g	TL/Ad.
0615 01 0200	200	8"	6-22	220	5 94,57



KALİTE YÖNETİM SİSTEMİ BELGESİ

QUALITY MANAGEMENT SYSTEM CERTIFICATE



TÜRK STANDARLARI ENSTİTÜSÜ
bu belge ile

İZELTAŞ İZMİR EL-ALETLERİ SAN. VE TİC. A.Ş.
MERKEZ FAB. : KEMALPAŞA CAD. NO:303
IŞIKKENT/İZMİR
II.İTİSİS : SUTÇULER MAH. FABRİKA KÜMEEVLERİ
NO:3 KEMALPAŞA -
İZMİR / TÜRKİYE

kuruluşunun TS EN ISO 9001:2008 şartlarına uygun bir KALİTE YÖNETİM SİSTEMİNE sahip olduğunu onaylar.

TURKISH STANDARDS INSTITUTION
hereby certifies that the organization

İZELTAŞ İZMİR EL-ALETLERİ SAN. VE TİC. A.Ş.
MERKEZ FAB. : KEMALPAŞA CAD. NO:303
IŞIKKENT/İZMİR
II.İTİSİS : SUTÇULER MAH. FABRİKA KÜMEEVLERİ
NO:3 KEMALPAŞA -
İZMİR / TÜRKİYE

has a QUALITY MANAGEMENT SYSTEM which fulfills the requirements of the TS EN ISO 9001:2008



Belge kapsamı Ek'te verilmiştir

Scope of the certificate is given in annex

Belge No / Certificate No	KY-677-03/KG-98/09-R
Belge Tarihi / Date of Certificate	12.11.2015
Geçerlilik Tarihi / Valid Until	12.11.2018
Revizyon Tarihi / Date of Revision	12.11.2015
İlk Belge Tarihi / Initial Certification Date	09.03.1998

This certificate is valid provided that compliance with the certification requirement is maintained.

TÜRK STANDARLARI ENSTİTÜSÜ

TURKISH STANDARDS INSTITUTION

Izmir Belgelendirme Müdürü
Izmir Certification Director

Ahmet NAMLI

Türk Standartları Enstitüsü Türk Akreditasyon Kurumu TÜRKAKK tarafından akredite edilmiştir.
Turkish Standards Institution, has been accredited by the Turkish Accreditation Agency TÜRKAKK.

Bu belge belgelendirme şartlarına uygunluk sağlandığı sürece geçerlidir.

351811201511281596

Lokma ve Bijon Anahtarları

2

Socket and Rim Wrenches

Lokma Anahtarlar
Lokma Aparatları
Lokma Takımları
Kovan Anahtarlar
Bijon Anahtarlar
Tork Anahtarları

Socket Wrenches
Socket Wrench Set
Tubular Socket Wrenches
Rim Wrenches
Torque Wrenches



1107

1/4" Altı Köşe Lokma Anahtar (mm)
Socket Wrench 6 Points (mm)

TS ISO 2725 • DIN 3124

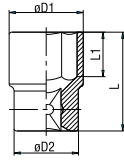

1/4"

Krom vanadyum, Krom kaplı , Polisajlı
Chrom vanadium, Chrom plated, Polished

KOD CODE	mm	ø D1 mm	ø D2 mm	L mm	L1 mm	g		TL/Ad.
1107 06 0004	4	6.8	11.8	24.5	4	10	10	2,90
1107 06 0045	4.5	7.4	11.8	24.5	5	10	10	2,90
1107 06 0005	5	8	11.8	24.5	6	10	10	2,90
1107 06 0055	5.5	8.7	11.8	24.5	6	10	10	2,90
1107 06 0006	6	9.2	11.8	24.5	7	10	10	2,90
1107 06 0007	7	10.3	11.8	24.5	7	10	10	2,90
1107 06 0008	8	11.4	11.8	24.5	8	10	10	2,90
1107 06 0009	9	12.9	12.2	24.5	8	15	10	3,04
1107 06 0010	10	14.3	13	24.5	9	20	10	3,04
1107 06 0011	11	15.8	14.2	24.5	9	20	10	3,83
1107 06 0012	12	16.8	15.5	24.5	9	25	10	3,83
1107 06 0013	13	17.8	16.5	24.5	9	30	10	4,36

1107

1/4" Altı Köşe Derin Lokma Anahtar (mm)
Deep Socket Wrench 6 Points (mm)

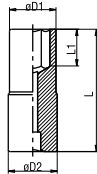

1/4"

Krom vanadyum, Krom kaplı , Polisajlı
Chrom vanadium, Chrom plated, Polished

KOD CODE	mm	ø D1 mm	ø D2 mm	L mm	L1 mm	g		TL/Ad.
1107 06 4004	4	6.8	11.8	50	6	10	10	5,81
1107 06 4045	4.5	7.4	11.8	50	7	10	10	----
1107 06 4005	5	8	11.8	50	7	20	10	5,81
1107 06 4055	5.5	8.7	11.8	50	9	20	10	5,81
1107 06 4006	6	9.2	11.8	50	9	25	10	6,46
1107 06 4007	7	10.3	11.8	50	15	25	10	6,46
1107 06 4008	8	11.8	11.8	50	15	25	10	6,46
1107 06 4009	9	13	13	50	15	30	10	6,46
1107 06 4010	10	14.5	14.5	50	15	40	10	6,46
1107 06 4011	11	15.8	15.8	50	21	45	10	7,03
1107 06 4012	12	16.8	16.8	50	21	50	10	7,03
1107 06 4013	13	17.8	17.8	50	21	55	10	7,03

1207

1/4" Sekiz Köşe Lokma Anahtar (mm)
Socket Wrench 8 Points (mm)

TS ISO 2725 • DIN 3124

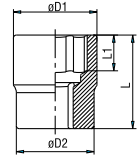

1/4"

Krom vanadyum, Krom kaplı , Polisajlı
Chrom vanadium, Chrom plated, Polished

KOD CODE	mm	ø D1 mm	ø D2 mm	L mm	L1 mm	g		TL/Ad.
1207 06 8008	8	12.2	12.2	24.5	6	15	10	4,36
1207 06 8010	10	14.7	14.7	24.5	7	25	10	5,13

1507

1/4" Cırcır Kolu
Ratchet Handle

TS ISO 3315 • DIN 3122



1/4"

Krom vanadyum, Krom kaplı , Polisajlı
Chrom vanadium, Chrom plated, Polished

KOD CODE	L mm	g		TL/Ad.
1507 06 0140	140	140	5	30,09

1507

1/4" Ara Kol
Extension Bar

TS ISO 1174 • DIN 3123



1/4"

Krom vanadyum, Krom kaplı , Polisajlı
Chrom vanadium, Chrom plated, Polished

KOD CODE	L mm	g		TL/Ad.
1507 06 0050	50	25	5	7,70
1507 06 0100	100	45	5	8,40

1507

1/4" Mafsallı
Universal Joint

TS ISO 1174 • DIN 3123



1/4"

Krom vanadyum, Krom kaplı , Polisajlı
Chrom vanadium, Chrom plated, Polished

KOD CODE	L mm	g		TL/Ad.
1507 06 0038	38	25	5	14,10

1507

1/4" T Kol
Sliding T - Handle

TS ISO 3315 • DIN 3122

1/4"

Krom vanadyum, Krom kaplı, Polisajlı
Chrom vanadium, Chrom plated, Polished

KOD CODE	L mm	g		TL/Ad.
1507 06 4115	115	45	5	12,87

1507

1/4" Mafsallı Kol
Flexible Handle

TS ISO 3315 • DIN 3122

1/4"

Krom vanadyum, Krom kaplı, Polisajlı
Chrom vanadium, Chrom plated, Polished

KOD CODE	L mm	g		TL/Ad.
1507 06 0130	130	85	5	34,91

1507

1/4" Derin Lokma Tornavida Adaptörü
Spindle Handle

DIN 3122

1/4"

Krom vanadyum, Krom kaplı, Polisajlı
Chrom vanadium, Chrom plated, Polished

KOD CODE	L mm	L1 mm	g		TL/Ad.
1507 06 4080	150	65	100	10	14,84

1507

1/4" Lokma Adaptörü
Adapter

TS ISO 1174 • DIN 3123

1/4"

Krom vanadyum, Krom kaplı, Polisajlı
Chrom vanadium, Chrom plated, Polished

KOD CODE	inch	g		TL/Ad.
1507 06 0004	1/4"Fx3/8"M	20	5	10,54

1107

1/4" Karbüratör Lokma Takımı
(18 parça, mm)
Socket Wrench Set
(18 pcs, mm)

1/4"

KOD CODE	LOKMLAR Sockets	AVADANLIKLAR Accessories	g		TL/Ad.
1107 00 6018	4 - 5 - 6 7 - 8 - 9 - 10 11 - 12 - 13 Altı Köşe Six Points 8 - 10 Sekiz Köşe Eight Points	1/4" Cırcır kolu Ratchet Handle	960	18	172,15
		1/4" Mafsal Universal Joint			
		1/4" T Kol Sliding T Handle			
		1/4" Ara Kol Extension Bar 50 mm			
		1/4" Ara Kol Extension Bar 100 mm			
		1/4" Mafsallı Kol Flexible Handle			



1110

3/8" Altı Köşe Lokma Anahtar (mm)
Socket Wrench 6 Points (mm)

TS ISO 2725 • DIN 3124

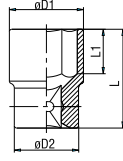

3/8"
Krom vanadyum, Krom kaplı, Polisajlı
Chrom vanadium, Chrom plated, Polished

KOD CODE	mm	Ø D1 mm	Ø D2 mm	L mm	L1 mm	g	TL/Ad.
1110 06 0006	6	9.8	17.8	27	9	25	10, 8,94
1110 06 0007	7	10.8	17.8	27	9	25	10, 8,94
1110 06 0008	8	12	17.8	27	9	25	10, 8,94
1110 06 0009	9	13.2	17.8	27	9	25	10, 8,94
1110 06 0010	10	14.5	17.8	27	9	25	10, 8,94
1110 06 0011	11	15.8	17.8	27	9	30	10, 8,94
1110 06 0012	12	16.8	17.8	27	9	30	10, 8,94
1110 06 0013	13	17.8	16.8	27	9	30	10, 9,63
1110 06 0014	14	19.6	17.5	29	11	35	10, 9,63
1110 06 0015	15	20.8	18	29	11	45	10, 9,63
1110 06 0016	16	21.8	19	29	11	45	10, 10,07
1110 06 0017	17	23.4	20	29	11	55	10, 10,07
1110 06 0018	18	24.7	21	29	13	60	10, 10,07
1110 06 0019	19	25.8	22	29	13	65	10, 10,51
1110 06 0020	20	27.1	24	32	13	75	10, ----
1110 06 0021	21	27.8	24	32	13	80	10, 10,51
1110 06 0022	22	29.7	26	32	15	85	10, 10,51
1110 06 0023	23	29.7	26	32	15	90	10, ----

1110

3/8" Buji Lokma Anahtar Lastikli
Spark Plug Socket with Rubber

TS ISO 2725 • DIN 3124



3/8"
Krom vanadyum, Krom kaplı, Polisajlı
Chrom vanadium, Chrom plated, Polished

KOD CODE	mm	L mm	g	TL/Ad.
1110 06 9208	21	70	145	10, 8,60



1510

3/8" Cırcır Kolu
Ratchet Handle

TS ISO 3315 • DIN 3122



3/8"
Krom vanadyum, Krom kaplı, Polisajlı
Chrom vanadium, Chrom plated, Polished

KOD CODE	L mm	g	TL/Ad.
1510 06 0200	200	295	5, 79,42

1510

3/8" Ara Kol
Extension Bar

TS ISO 1174 • DIN 3123



3/8"
Krom vanadyum, Krom kaplı, Polisajlı
Chrom vanadium, Chrom plated, Polished

KOD CODE	L mm	g	TL/Ad.
1510 06 0075	75	75	5, 16,14
1510 06 0150	150	145	5, 20,88

1510

3/8" Mafsal
Universal Joint

TS ISO 1174 • DIN 3123



3/8"
Krom vanadyum, Krom kaplı, Polisajlı
Chrom vanadium, Chrom plated, Polished

KOD CODE	L mm	g	TL/Ad.
1510 06 0056	56.5	60	5, 26,39

1510

3/8" T Kol
Sliding T - Handle

TS ISO 3315 • DIN 3122



3/8"
Krom vanadyum, Krom kaplı, Polisajlı
Chrom vanadium, Chrom plated, Polished

KOD CODE	L mm	g	TL/Ad.
1510 06 1200	200	180	5, 27,79

1510

3/8" Mafsallı Kol
Flexible Handle

TS ISO 3315 • DIN 3122



3/8"

Krom vanadyum, Krom kaplı, Polisajlı
Chrom vanadium, Chrom plated, Polished

KOD CODE	L mm	g	TL/Ad.
1510 06 0215	215	310	5 50,02

1510

3/8" Lokma Adaptörü
Adapter

TS ISO 1174 • DIN 3123



3/8"

Krom vanadyum, Krom kaplı, Polisajlı
Chrom vanadium, Chrom plated, Polished

KOD CODE	inch	g	TL/Ad.
1510 06 0006	3/8"Fx1/4"M	25	5 ----
1510 06 0007	3/8"Fx1/2"M	45	5 15,98

1110

3/8" Altı Köşe Lokma Takımı (20 parça, mm)
6 Points Socket Wrench Set (20 Pcs, mm)



3/8"

KOD CODE	LOKMARLAR Sockets	AVADANLIKLAR Accessories	g	TL/Ad.
1110 00 6020	6 - 7 - 8 - 9 - 10	3/8" Cırcır Kolu Ratchet Handle	2500	20 369,13
	11 - 12 - 13 - 14	3/8" Mafsallı Universal Joint		
	17 - 19 - 21 22	3/8" T Kol Sliding T Handle		
	Altı Köşe Six Points	3/8" Ara Kol Extension Bar 75 mm		
	20.8 Buji Lokma Lastikli Altı Köşe Rubber Six Points	3/8" Ara Kol Extension Bar 150 mm		
		3/8" Mafsallı Kol Flexible Handle		

1108

1/2" Derin Lokma Altı Köşe (mm)
Deep Socket Wrench 6 Points (mm)

TS ISO 2725 • DIN 3124

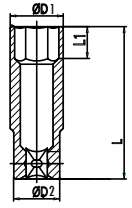

1/2"

Krom vanadyum, Krom kaplı
Chrom vanadium, Chrom plated

KOD CODE	mm	ØD1 mm	ØD2 mm	L mm	L1 mm	g	TL/Ad.
1108 06 0010	10	15,5	24	75	6	110	10 29,83
1108 06 0011	11	16,7	24	75	7	110	10 29,83
1108 06 0012	12	18	24	75	8	110	10 29,83
1108 06 0013	13	19,2	24	75	8	120	10 32,05
1108 06 0014	14	20,5	24	75	10	120	10 32,05
1108 06 0015	15	21,7	24	75	10	140	10 32,05
1108 06 0016	16	23	25,5	75	10	140	10 33,54
1108 06 0017	17	24,2	25,5	75	10	140	10 33,54
1108 06 0018	18	25,5	25,5	75	12	150	10 33,54
1108 06 0019	19	26,7	26,7	75	12	150	10 35,05

1108

1/2" Derin Lokma Takımı
Deep Socket Set



1/2"



KOD CODE	L mm	g	TL/Ad.
1108 00 6010	10-11-12-13-14-15 16-17-18-19	1290	10 321,31



1113

1/2" Altı Köşe Lokma Anahtar (mm)
Socket Wrench 6 Points (mm)

TS ISO 2725 • DIN 3124

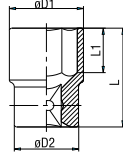

1/2"

Krom vanadyum, Krom kaplı
Chrom vanadium, Chrom plated,

KOD CODE	mm	ø D1 mm	ø D2 mm	L mm	L1 mm	g	TL/Ad.
1113 06 1008	8	13.2	21.8	38	7	55	10, 9,00
1113 06 1009	9	14	21.8	38	7	55	10, 9,00
1113 06 1010	10	15	23.3	38	8	55	10, 14,92
1113 06 1011	11	16.4	23.3	38	8	60	10, 14,92
1113 06 1012	12	17.8	23.3	38	9	60	10, 14,92
1113 06 1013	13	19	23.3	38	10	65	10, 16,04
1113 06 1014	14	20.4	23.3	38	11	65	10, 16,04
1113 06 1015	15	21.6	23.3	38	11	65	10, 16,04
1113 06 1016	16	22.9	24	38	11	70	10, 16,79
1113 06 1017	17	24	22.5	38	12	70	10, 16,79
1113 06 1018	18	25.2	23	38	13	75	10, 16,79
1113 06 1019	19	26.8	23	38	13	75	10, 17,52
1113 06 1020	20	28	23	38	13	80	10, 17,52
1113 06 1021	21	29.2	23	38	13	85	5, 17,52
1113 06 1022	22	30.2	24	40	15	95	5, 17,52
1113 06 1023	23	31.4	25	40	15	100	5, 18,28
1113 06 1024	24	32.6	26	42	17	115	5, 18,28
1113 06 1025	25	34	27	42	17	125	5, 18,28
1113 06 1026	26	35.3	28	42	17	135	5, 18,28
1113 06 1027	27	36.6	28	42	19	140	5, 20,97
1113 06 1028	28	37.8	30	42	20	160	5, 20,97
1113 06 1029	29	39	30	44	21	170	5, 20,97
1113 06 1030	30	40	29.5	44	21	180	5, 20,97
1113 06 1032	32	42.5	30	44	23	190	5, 20,97

1114

1/2" Oniki Köşe Lokma Anahtar (mm)
Socket Wrench 12 Points (mm)

TS ISO 2725 • DIN 3124

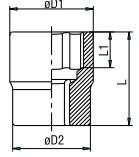

1/2"

Krom vanadyum, Krom kaplı , Polished
Chrom vanadium, Chrom plated, Polished

KOD CODE	mm	ø D1 mm	ø D2 mm	L mm	L1 mm	g	TL/Ad.
1114 06 1010	10	15	23.3	38	8	60	10, 15,95
1114 06 1011	11	16.4	23.3	38	8	60	10, 15,95
1114 06 1012	12	17.8	23.3	38	9	60	10, 15,95
1114 06 1013	13	19	23.3	38	10	60	10, 17,16
1114 06 1014	14	20.4	23.3	38	11	60	10, 17,16
1114 06 1015	15	21.6	23.3	38	11	65	10, 17,16
1114 06 1016	16	22.9	24	38	11	70	10, 17,94
1114 06 1017	17	24	22.5	38	12	70	10, 17,94
1114 06 1018	18	25.2	23	38	13	70	10, 17,94
1114 06 1019	19	26.8	23	38	13	75	10, 18,74
1114 06 1020	20	28	23	38	13	80	10, 18,74
1114 06 1021	21	29.2	23	38	13	80	5, 18,74
1114 06 1022	22	30.2	24	40	15	95	5, 18,74
1114 06 1023	23	31.4	25	40	15	100	5, 19,56
1114 06 1024	24	32.6	26	42	17	105	5, 19,56
1114 06 1025	25	34	27	42	17	125	5, ----
1114 06 1026	26	35.3	28	42	17	135	5, 19,56
1114 06 1027	27	36.6	28	42	19	135	5, 22,43
1114 06 1028	28	37.8	30	42	20	155	5, 22,43
1114 06 1029	29	39	30	44	21	165	5, ----
1114 06 1030	30	40	30	44	21	165	5, 22,43
1114 06 1032	32	42.5	30	44	23	180	5, 22,43



1413

1/2" Oniki Köşe Lokma Anahtar (SAE) Socket Wrench 12 Points (SAE)

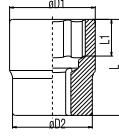

1/2"

Krom vanadyum, Krom kaplı , Polisajlı
Chrom vanadium, Chrom plated, Polished

KOD CODE	inch	Ø D1 mm	Ø D2 mm	L mm	L1 mm	g	TL/Ad.
1413 06 1008	5/16"	13.2	21.8	37	6	45	10, 17,06
1413 06 1095	3/8"	15	21.8	37	8	50	10, 17,06
1413 06 1010	7/16"	16.4	23.3	37	9	60	10, 17,06
1413 06 1011	15/32"	18	23.3	37	9	60	10, 17,06
1413 06 1012	1/2"	19	23.3	37	9	60	10, 18,35
1413 06 1013	9/16"	20.4	23.3	37	11	60	10, 18,35
1413 06 1014	19/32"	21.6	23.3	37	11	65	10, 18,35
1413 06 1015	5/8"	23.1	22	38	11	70	10, 19,21
1413 06 1016	11/16"	24.5	22.5	38	11	70	10, 19,21
1413 06 1017	3/4"	26.8	23	38	13	75	10, 20,08
1413 06 1020	25/32"	28	23	38	13	75	10, 20,08
1413 06 1021	13/16"	28.6	23	38	13	80	10, 20,08
1413 06 1022	7/8"	30.2	24	40	15	90	5, 20,08
1413 06 1024	15/16"	32.6	26	42	17	115	5, 20,92
1413 06 1025	1"	35	28	42	17	130	5, 20,92
1413 06 1027	1 1/16"	36.6	28	42	19	135	5, 23,98
1413 06 1029	1 1/8"	38.8	30	42	19	170	5, 23,98
1413 06 1030	1 3/16"	40	29.5	44	20	170	5, 23,98
1413 06 1032	1 1/4"	42.5	30	44	22	185	5, 23,98

1113

1/2" Manyetik Lokma (mm) Socket Wrench 6 Points (mm)

TS ISO 2725 • DIN 3124

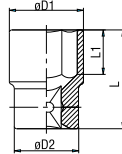

1/2"

Krom vanadyum, Krom kaplı , Polisajlı
Chrom vanadium, Chrom plated, Polished

KOD CODE	mm	Ø D1 mm	Ø D2 mm	L mm	L1 mm	g	TL/Ad.
1113 06 3008	8	13.2	21.8	38	7	55	10, 10,80
1113 06 3010	10	15	23.3	38	8	55	10, 17,91
1113 06 3012	12	17.8	23.3	38	9	60	10, 17,91
1113 06 3014	14	20.4	23.3	38	11	65	10, 19,23

1113

1/2" Manyetik Lokma ve Torx® Uç (mm) Magnetic Socket Wrench 6 Points (mm) - Torx® Bits

TS ISO 2725 • DIN 3124



1/2"

Krom vanadyum, Krom kaplı , Polisajlı
Chrom vanadium, Chrom plated, Polished

KOD CODE	UYUMLU UÇLAR COMPATIBLE DIMENSIONS	g	TL/Ad.
1113 06 3008	8 Manyetik Lokma Socket Wrench	55	10, 10,80
1113 06 3120	T20 Torx® Uçlar	9	10, 4,70
1113 06 3125	T25 Torx® Uçlar	9	10, 4,70
1113 06 3127	T27 Torx® Uçlar	9	10, 4,70
1113 06 3130	T30 Torx® Uçlar	9.4	10, 4,70
1113 06 3140	T40 Torx® Uçlar	10.2	10, 4,70
1113 06 3145	T45 Torx® Uçlar	11	10, 5,71
1113 06 3150	T50 Torx® Uçlar	11.7	10, 6,07
1113 06 3010	10 Manyetik Lokma Socket Wrench	55	10, 17,91
1113 06 3155	T55 Torx® Uç/Torx® Bits	18.2	10, 6,58
1113 06 3014	14 Manyetik Lokma Socket Wrench	65	10, 19,23
1113 06 3160	T60 Torx® Uç/Torx® Bits	31.6	10, 7,12



1113

1/2" Manyetik Lokma ve Allen Uç (mm) TS ISO 2725 • DIN 3124
Magnetic Socket Wrench 6 Points (mm) - Hex Bits



1/2"

Krom vanadyum, Krom kaplı , Polisajlı
Chrom vanadium, Chrom plated, Polished

KOD CODE	mm	UYUMLU UÇLAR COMPATIBLE DIMENSIONS	g	TL/Ad.
1113 06 3008	8	Manyetik Lokma Socket Wrench	55	10,80
1113 06 3205	5	Allen Uçlar Hex Bits	12	4,70
1113 06 3206	6		13	4,70
1113 06 3207	7		14	4,70
1113 06 3208	8		14	4,70
1113 06 3010	10	Manyetik Lokma Socket Wrench	55	17,91
1113 06 3210	10	Allen Uç/Hex Bits	24	4,83
1113 06 3012	12	Manyetik Lokma Socket Wrench	60	17,91
1113 06 3212	12	Allen Uç/Hex Bits	37	4,97
1113 06 3014	14	Manyetik Lokma Socket Wrench	65	19,23
1113 06 3214	14	Allen Uç/Hex Bits	42	5,56

1113

1/2" Manyetik Lokmalı Uç Takımı (20 Parça)
Magnetic Hex Bit Sockets - Torx® Bit Sockets Set
(20 Pcs)



1/2"

KOD CODE	İÇERİK CONTENTS	TL/Ad.
1113 00 3020	Manyetik Lokma (1/2") 8 - 10 - 12 - 14	20 148,99
	Allen Uç Hex Bit Socket 5-6-7-8-10-12-14	
	Torx® Uçlar T20 - T25 - T27 T30 - T40 T45 - T50 - T55 - T60	

1113

1/2" Star Lokma Anahtar
Star Socket



1/2"

Krom vanadyum, Krom kaplı , Polisajlı
Chrom vanadium, Chrom plated, Polished

KOD CODE	mm	Ø D1 mm	Ø D2 mm	L mm	L1 mm	g	TL/Ad.
1113 06 0210	E10	13.2	23.8	37	7.5	60	10, 13,23
1113 06 0212	E12	15	23.8	37	9	65	10, 13,23
1113 06 0214	E14	16.4	23.8	37	10	65	10, 13,23
1113 06 0216	E16	18.8	23.8	37	11	70	10, 13,23
1113 06 0218	E18	20.5	23.8	39	12.5	75	10, 13,23
1113 06 0220	E20	23	23.8	39	14	75	10, 14,84

1113

1/2" Buji Lokma Anahtar (Lastikli)
Spark Plug Socket with Rubber



1/2"

Krom vanadyum, Krom kaplı , Polisajlı
Chrom vanadium, Chrom plated, Polished

KOD CODE	mm	L mm	g	TL/Ad.
1113 06 9160	16	70	80	10, 18,63
1113 06 9208	21	70	155	10, 20,42



1113

1/2" Lokma Anahtar Sehpası
Display Frame for Sockets

1/2"

KOD CODE	İÇERİK CONTENTS	g	□	TL/Ad.
1113 00 6145	Dolu (10-11-12-13-14-15 16-17-18-19) x 10 (21-22-23-24-26-27 28-30-32) x 5	18.236	1	2603,31

1113

1/2" Lokmalı Allen Uç ve Star (Torx)® Uç Takımı (17 Parça)
Hex Bit Sockets - Torx Bit Sockets Set (17 Pcs)

1/2"

KOD CODE	İÇERİK CONTENTS	□	TL/Ad.
1113 00 6017	T KOL (1/2") Sliding T Handle 5 - 6 - 7 - 8 - 10 12 - 14 Lokmalı Allen Uç Hex Bit Socket T20 - T25 - T27 T30 - T40 T45 - T50 - T55 - T60 Lokmalı Torx Allen Uç Torx Bit Socket	17	364,48

1113

1/2" Lokmalı Allen Uçlar (mm)
Hexagonal Bits Socket (mm)

1/2"

KOD CODE	mm	L mm	g	□	TL/Ad.
1113 06 1104	4	60	70	10	-----
1113 06 1105	5	60	70	10	17,63
1113 06 1106	6	60	70	10	17,63
1113 06 1107	7	60	75	10	17,63
1113 06 1108	8	60	75	10	17,63
1113 06 1110	10	60	85	10	17,63
1113 06 1112	12	60	100	10	17,63
1113 06 1114	14	60	115	10	20,11

1113

1/2" Lokmalı Star (Torx)® Uçlar
Star Bits Socket

1/2"

KOD CODE	★	L mm	g	□	TL/Ad.
1113 06 1220	T20	60	70	10	21,76
1113 06 1225	T25	60	70	10	21,76
1113 06 1227	T27	60	70	10	21,76
1113 06 1230	T30	60	70	10	21,76
1113 06 1240	T40	60	70	10	21,76
1113 06 1245	T45	60	70	10	21,76
1113 06 1250	T50	60	75	10	21,76
1113 06 1255	T55	60	80	10	21,76
1113 06 1260	T60	60	100	10	21,76



1114

1/2" Oniki Köşe Lokmalı Bits Uç
Kısa Boy Yivli (mm)
Hex Bit Socket Short 12 Points (mm)



1/2"

Krom vanadyum, Krom kaplı , Polisajlı
Chrom vanadium, Chrom plated, Polished

KOD CODE		L mm	g		TL/ Ad.
1114 06 4005	5	60	60	10	13,40
1114 06 4006	6	60	62	10	13,40
1114 06 4008	8	60	62	10	13,40
1114 06 4010	10	60	78	10	13,40
1114 06 4012	12	60	84	10	13,40

1114

1/2" Oniki Köşe Lokmalı Bits Uç Orta Boy Yivli (mm)
Hex Bit Socket 12 Points (mm)



1/2"

Krom vanadyum, Krom kaplı , Polisajlı
Chrom vanadium, Chrom plated, Polished

KOD CODE		L mm	g		TL/ Ad.
1114 06 4106	6	80	69	10	14,71
1114 06 4108	8	80	70	10	14,71
1114 06 4110	10	80	84	10	16,25
1114 06 4112	12	80	103	10	18,00
1114 06 4114	14	80	133	10	19,10

1114

1/2" Oniki Köşe Lokmalı Bits Uç Uzun Boy Yivli (mm)
Hex Bit Socket Long 12 Points (mm)

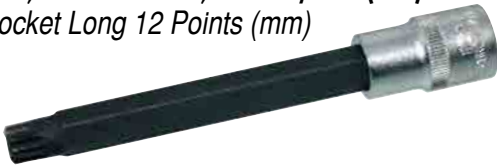

1/2"

Krom vanadyum, Krom kaplı , Polisajlı
Chrom vanadium, Chrom plated, Polished

KOD CODE		L mm	g		TL/ Ad.
1114 06 4208	8	140	96	10	20,65
1114 06 4210	10	140	125	10	25,26
1114 06 4212	12	140	161	10	28,55
1114 06 4214	14	140	210	10	32,05
1114 06 4216	16	140	281	10	46,54

1114

1/2" Lokmalı (RİBE) Bits Uç (mm)
Socket Wrench 6 Points (mm)



1/2"

Krom vanadyum, Krom kaplı , Polisajlı
Chrom vanadium, Chrom plated, Polished

KOD CODE		L mm	g		TL/ Ad.
1114 06 5004	4	100	75	10	18,88
1114 06 5005	5	100	76	10	18,88
1114 06 5006	6	100	76	10	18,88
1114 06 5007	7	100	77	10	18,88
1114 06 5008	8	100	78	10	18,88
1114 06 5009	9	100	85	10	19,10
1114 06 5010	10	100	96	10	19,10
1114 06 5011	10.5	100	96	10	19,55
1114 06 5012	12	100	121	10	24,37
1114 06 5013	13	100	148	10	26,77
1114 06 5014	14	100	150	10	26,77
1114 06 5016	16	100	198	10	36,22

1513

1/2" T Kol
Sliding T - Handle

TS ISO 3315 • DIN 3122



1/2"

Krom vanadyum, Krom kaplı , Polisajlı
Chrom vanadium, Chrom plated, Polished

KOD CODE	L mm	g		TL/ Ad.
1513 06 2250	250	355	5	42,75

1513

1/2" U Kol
Speed brace with revolving rubber handle

TS ISO 3315 • DIN 3122



1/2"

Krom vanadyum, Krom kaplı , Polisajlı
Chrom vanadium, Chrom plated, Polished

KOD CODE	L mm	g		TL/ Ad.
1513 06 4420	420	500	5	74,21

1513
1/2" Lokma Adaptörü
Adapter

TS ISO 1174 • DIN 3123

1/2"

 Krom vanadyum, Krom kaplı, Polisajlı
Chrom vanadium, Chrom plated, Polished

KOD CODE	inch	g		TL/Ad.
1513 06 0002	1/2"Fx3/8"M	55	5	11,73
1513 06 0003	1/2"Fx3/4"M	115	5	17,13

1513
1/2" Cırcır Kolu (32 Diş)
Ratchet Handle

TS ISO 3315 • DIN 3122

1/2"

 Krom vanadyum, Krom kaplı, Polisajlı
Chrom vanadium, Chrom plated, Polished

KOD CODE	L mm	g		TL/Ad.
1513 06 0032	250	580	5	97,04

1513
1/2" Cırcır Kolu (72 Diş)
Max Gear Raichet Handle

TS ISO 3315 • DIN 3122

1/2"

 Krom vanadyum, Krom kaplı, Polisajlı
Chrom vanadium, Chrom plated, Polished

KOD CODE	L mm	g		TL/Ad.
1513 06 0072	250	460	5	126,06

1513
1/2" Ara Kol
Extension Bar

TS ISO 1174 • DIN 3123

1/2"

 Krom vanadyum, Krom kaplı, Polisajlı
Chrom vanadium, Chrom plated, Polished

KOD CODE	L mm	g		TL/Ad.
1513 06 4125	125	215	5	26,91
1513 06 4250	250	420	5	45,17

1513
1/2" Mafsal
Universal Joint

TS ISO 1174 • DIN 3123

1/2"

 Krom vanadyum, Krom kaplı, Polisajlı
Chrom vanadium, Chrom plated, Polished

KOD CODE	L mm	g		TL/Ad.
1513 06 4070	70	140	5	43,97

1113
1/2" Altı Köşe Lokma Anahtar Takımı (18 Parça, mm)
Socket Wrench Set 6 Points (18 pcs, mm)

1/2"

KOD CODE	LOKMALAR Sockets	AVADANLIKLAR Accessories	g		TL/ Ad.
1113 00 6018	10 - 11 - 12 13 - 14 - 15 17 - 19 - 22 24 - 27 - 30 32	1/2" Cırcır Kolu Ratchet Handle	3300	18	538,18
		1/2" U Kol Speed Brace with Revolving Rubber Handle			
		1/2" T Kol Sliding T Handle			
		1/2" Mafsal Universal Joint			
		1/2" Ara Kol Extension Bar 250 mm			



1113

1/2" Altı Köşe Lokma Anahtar Takımı (17 Parça, mm)
Socket Wrench Set 1/2" 6 Points (17 pcs, mm)

1/2"

KOD CODE	LOKMALAR Sockets	AVADANLIKLAR Accessories	g	TL/Ad.	
1113 00 2017	10 - 11 - 12 13 - 14 - 15 17 - 19 - 22 24 - 27 - 30 32	1/2" Cırcır Kolu Ratchet Handle	2880	17	476,05
		1/2" T Kol Sliding T Handle			
		1/2" Mafsal Universal Joint			
		1/2" Ara Kol Extension Bar 250 mm			

1113

1/2" Altı Köşe Lokma Anahtar Takımı (25 Parça, mm)
Socket Wrench Set 6 Points (25 pcs, mm)

1/2"

KOD CODE	LOKMALAR Sockets	AVADANLIKLAR Accessories	g	TL/Ad.	
1113 00 6025	10 - 11 - 12 13 - 14 - 15 16 - 17 - 18 19 - 21 - 22 23 - 24 - 26 27 - 28 - 30 32	1/2" Cırcır Kolu Ratchet Handle	4150	25	679,28
		1/2" U Kol Speed Brace with Revolving Rubber Handle			
		1/2" Mafsal Universal Joint			
		1/2" T Kol Sliding T Handle			
		1/2" Ara Kol Extension Bar 125 mm			
		1/2" Ara Kol Extension Bar 250 mm			

1113

1/2" Altı Köşe Lokma Anahtar Takımı (24 Parça, mm)
Socket Wrench Set 1/2" 6 Points (24 pcs, mm)

1/2"

KOD CODE	LOKMALAR Sockets	AVADANLIKLAR Accessories	g	TL/Ad.	
1113 00 2024	10 - 11 - 12 13 - 14 - 15 16 - 17 - 18 19 - 21 - 22 23 - 24 - 26 27 - 28 - 30 32	1/2" Cırcır Kolu Ratchet Handle	3650	24	649,74
		1/2" Mafsal Universal Joint			
		1/2" T Kol Sliding T Handle			
		1/2" Ara Kol Extension Bar 125 mm			
		1/2" Ara Kol Extension Bar 250 mm			

1114

1/2" Oniki Köşe Lokma Anahtar Takımı (25 Parça, mm)
Socket Wrench Set 12 Points (25 pcs, mm)

1/2"

KOD CODE	LOKMALAR Sockets	AVADANLIKLAR Accessories	g	TL/Ad.	
1114 00 6025	10 - 11 - 12 13 - 14 - 15 16 - 17 - 18 19 - 21 - 22 23 - 24 - 26 27 - 28 - 30 32	1/2" Cırcır Kolu Ratchet Handle	4150	25	711,87
		1/2" U Kol Speed Brace with Revolving Rubber Handle			
		1/2" Mafsal Universal Joint			
		1/2" T Kol Sliding T Handle			
		1/2" Ara Kol Extension Bar 125 mm			
		1/2" Ara Kol Extension Bar 250 mm			

1413

1/2" Oniki Köşe Lokma Anahtar Takımı (25 parça, SAE)
Socket Wrench Set 12 Points (25 pcs, SAE)



1/2"

KOD CODE	LOKMALAR Sockets	AVADANLIKLAR Accessories	g		TL/Ad.
1413 00 6025		1/2" Cırcır Kolu Ratchet Handle	4150	25	726,84
	5/16" - 3/8"	1/2" U Kol Speed Brace with Revolving Rubber Handle			
	7/16" - 15/32"				
	1/2" - 9/16"				
	19/32" - 5/8"				
	11/16" - 3/4"	1/2" Mafsals Universal Joint			
	25/32" - 13/16"				
	7/8" - 15/16"	1/2" T Kol Sliding T Handle			
	1" - 1 1/16"				
	1 1/8" - 1 3/16"	1/2" Ara Kol Extension Bar 125 mm			
1 1/4"	1/2" Ara Kol Extension Bar 250 mm				



1113

1/2" Altı Köşe Havalı Lokma Anahtar (mm)
Impact Socket Wrench 6 Points (mm)

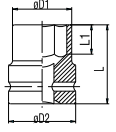

1/2"

Krom molibden, Fosfat kaplamalı
Chrom molybdenum, Phosphate finish

KOD CODE	mm	ø D1 mm	ø D2 mm	L mm	L1 mm	g		TL/Ad.
1113 06 7008	8	14	25	38	7	65	10	-----
1113 06 7009	9	15	25	38	7	65	10	-----
1113 06 7010	10	17	25	38	8	70	10	17,16
1113 06 7011	11	18	25	38	8	70	10	17,16
1113 06 7012	12	19	25	38	9	70	10	17,16
1113 06 7013	13	20	25	38	10	70	10	18,43
1113 06 7014	14	22	25	38	10	75	10	18,43
1113 06 7015	15	23	30	38	11	110	10	18,43
1113 06 7016	16	24	30	38	11	110	10	19,28
1113 06 7017	17	26	30	38	12	115	10	19,33
1113 06 7018	18	27	30	38	13	115	10	19,39
1113 06 7019	19	28	30	38	13	120	10	19,76
1113 06 7020	20	29	30	38	13	120	10	-----
1113 06 7021	21	30	30	40	14	125	5	20,15
1113 06 7022	22	32	30	40	14	145	5	20,15
1113 06 7023	23	33	30	40	15	150	5	-----
1113 06 7024	24	34	30	42	15	150	5	21,02
1113 06 7025	25	36	30	42	15	170	5	-----
1113 06 7026	26	37	30	42	15	175	5	-----
1113 06 7027	27	38	30	44	16	175	5	24,10
1113 06 7028	28	41	30	44	16	195	5	-----
1113 06 7029	29	41	30	44	17	195	5	-----
1113 06 7030	30	42	30	44	17	200	5	-----
1113 06 7032	32	44	30	44	18	205	5	-----

1513

1/2" Havalı Lokma Adaptörü
Impact Socket Adapter



1/2"

Krom molibden, Fosfat kaplamalı
Chrom molybdenum, Phosphate finish

KOD CODE	inch	g		TL/Ad.
1513 06 7002	1/2"Fx3/8" M	95	5	29,90
1513 06 7003	1/2"Fx3/4" M	175	5	31,58

1513

1/2" Havalı Lokma Ara Kol
Impact Socket Extension Bar



1/2"

Krom molibden, Fosfat kaplamalı
Chrom molybdenum, Phosphate finish

KOD CODE	L mm	g	□	TL/Ad.
1513 06 7125	125	275	5	42,21
1513 06 7250	250	450	5	69,08

1513

1/2" Havalı Lokma Mafsals
Impact Socket Universal Joint



1/2"

Krom molibden, Fosfat kaplamalı
Chrom molybdenum, Phosphate finish

KOD CODE	L mm	g	□	TL/Ad.
1513 06 7075	75	220	5	52,88

1113

1/2" Alaşımli Jant 7'li Lokma Takımı
7 Pcs. Combination Lug Nut Socket Set



1/2"

KOD CODE	LOKMA LAR Sockets	g	□	TL/Ad.
1113 00 9007	17 - 19 - 21 - 22 23 - 24 - 27	2250	7	323,71

1119

3/4" Altı Köşe Lokma Anahtar (mm)
Socket Wrench 6 Points (mm)

TS ISO 2725 • DIN 3124

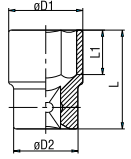

3/4"

Krom vanadyum, Krom kaplı, Polisajlı
Chrom vanadium, Chrom plated, Polished

KOD CODE	○ mm	ø D1 mm	ø D2 mm	L mm	L1 mm	g	□	TL/Ad.
1119 06 1018	18	28	36	52	14	220	5	-----
1119 06 1019	19	30	36	52	14	225	5	-----
1119 06 1021	21	32	36	52	16	225	5	-----
1119 06 1022	22	33	36	52	16	225	5	26,74
1119 06 1024	24	35	36	52	16	230	5	26,74
1119 06 1027	27	38	36	52	19	235	5	27,59
1119 06 1030	30	42	38	54	21	300	5	29,72
1119 06 1032	32	44	38	56	23	320	5	29,72
1119 06 1033	33	46	38	56	23	350	5	-----
1119 06 1034	34	47	42	58	24	400	5	38,82
1119 06 1036	36	50	42	58	25	440	5	38,82
1119 06 1038	38	52	45	60	27	500	5	38,82
1119 06 1041	41	56	45	64	29	580	1	59,88
1119 06 1046	46	62	48	68	33	730	1	63,68
1119 06 1050	50	68	48	72	34	885	1	76,92
1119 06 1055	55	76	48	76	37	1070	1	91,59
1119 06 1060	60	80	48	78	38	1170	1	109,90

1120

3/4" Oniki Köşe Lokma Anahtar (mm)
Socket Wrench 12 Points (mm)

TS ISO 2725 • DIN 3124

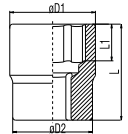

3/4"

Krom vanadyum, Krom kaplı, Polisajlı
Chrom vanadium, Chrom plated, Polished

KOD CODE	○ mm	ø D1 mm	ø D2 mm	L mm	L1 mm	g	□	TL/Ad.
1120 06 1022	22	33	36	52	16	220	5	28,07
1120 06 1024	24	35	36	52	17	225	5	28,07
1120 06 1027	27	38	36	52	19	225	5	28,95
1120 06 1030	30	42	38	54	21	285	5	31,22
1120 06 1032	32	44	38	56	23	310	5	31,22
1120 06 1034	34	47	42	57	24	385	5	40,77
1120 06 1036	36	50	42	58	25	435	5	40,77
1120 06 1041	41	56	45	64	29	560	1	62,90
1120 06 1046	46	62	47	68	34	685	1	66,88
1120 06 1050	50	68	48	72	34	840	1	80,78

1419

3/4" Oniki Köşe Lokma Anahtar (SAE) Socket Wrench 12 Points (SAE)

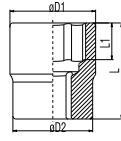

3/4"
Krom vanadyum, Krom kaplı, Polisajlı
Chrom vanadium, Chrom plated, Polished

KOD CODE	inch	ØD1 mm	ØD2 mm	L mm	L1 mm	g	TL/Ad.
1419 06 1022	7/8"	33	36	52	16	220	5 29,48
1419 06 1024	15/16"	35	36	52	16	220	5 29,48
1419 06 1025	1"	35	36	52	17	220	5 29,48
1419 06 1027	1 1/16"	38	36	52	19	225	5 30,40
1419 06 1028	1 1/8"	40	38	52	19	225	5 30,40
1419 06 1032	1 1/4"	44	38	56	23	315	5 32,78
1419 06 1033	1 5/16"	46	38	56	23	355	5 42,80
1419 06 1035	1 3/8"	48	42	58	25	400	5 42,80
1419 06 1036	1 7/16"	50	42	58	25	425	5 42,80
1419 06 1038	1 1/2"	52	45	60	27	475	5 42,80
1419 06 1041	1 5/8"	56	45	64	29	555	1 66,04
1419 06 1044	1 3/4"	60	47	66	31	660	1 70,21
1419 06 1046	1 13/16"	62	47	68	34	685	1 70,21
1419 06 1047	1 7/8"	64	48	70	34	730	1 84,82
1419 06 1050	2"	68	48	72	34	805	1 84,82

1519

3/4" Cırcır Kolu Ratchet Handle

TS ISO 3315 • DIN 3122



3/4"

Krom vanadyum, Krom kaplı, Polisajlı
Chrom vanadium, Chrom plated, Polished

KOD CODE	L mm	g	TL/Ad.
1519 06 4510	510	2230	5 272,12

1519

3/4" Ara Kol Extension Bar

TS ISO 1174 • DIN 3123



3/4"

Krom vanadyum, Krom kaplı, Polisajlı
Chrom vanadium, Chrom plated, Polished

KOD CODE	L mm	g	TL/Ad.
1519 06 4200	200	730	5 83,49
1519 06 4400	400	1370	5 151,38

1519

3/4" T Kol Sliding T - Handle

TS ISO 3315 • DIN 3122



3/4"

Krom vanadyum, Krom kaplı, Polisajlı
Chrom vanadium, Chrom plated, Polished

KOD CODE	L mm	g	TL/Ad.
1519 06 4500	500	1485	5 185,25

1519

3/4" Lokma Adaptörü Adapter

TS ISO 1174 • DIN 3123



3/4"

Krom vanadyum, Krom kaplı, Polisajlı
Chrom vanadium, Chrom plated, Polished

KOD CODE	inch	g	TL/Ad.
1519 06 0008	3/4"Fx1/2"M	140	5 22,50
1519 06 0001	3/4"Fx1"M	300	5 37,24

1119

3/4" Altı Köşe Lokma Anahtar Takımı (14 parça, mm) Socket Wrench Set 6 Points (14 pcs, mm)



3/4"

KOD CODE	LOKMALAR Sockets	AVADANLIKLAR Accessories	g	TL/Ad.
1119 00 6114	22 - 24 - 27 30 - 32 - 34 36 - 41 - 46 50	3/4" Cırcır Kolu Ratchet Handle	10180	14 1141,92
		3/4" T Kol Sliding T Handle		
		3/4" Ara Kol Extension Bar 200 mm		
		3/4" Ara Kol Extension Bar 400 mm		

1120

3/4" Oniki Köşe Lokma Anahtar Takımı (14 parça, mm)
Socket Wrench Set 12 Points (14 pcs, mm)



3/4"

KOD CODE	LOKMALAR Sockets	AVADANLIKLAR Accessories	g	TL/Ad.
1120 00 6014	22 - 24 - 27	3/4" Cırcır Kolu Ratchet Handle	13700	14 1176,05
	30 - 32 - 34	3/4" T Kol Sliding T Handle		
	36 - 41 - 46	3/4" Ara Kol Extension Bar 200 mm		
	50	3/4" Ara Kol Extension Bar 400 mm		

1419

3/4" Oniki Köşe Lokma Takımı (14 parça SAE)
Socket Wrench Set 12 Points (14 pcs, SAE)



3/4"

KOD CODE	LOKMALAR Sockets	AVADANLIKLAR Accessories	g	TL/Ad.
1419 00 6114	15/16" - 1 1/6"	3/4" Cırcır Kolu Ratchet Handle	10180	14 1234,70
	1 1/8" - 1 1/4"	3/4" T Kol Sliding T Handle		
	1 5/16" - 1 3/8"	3/4" Ara Kol Extension Bar 200 mm		
	1 1/2" - 1 5/8"	3/4" Ara Kol Extension Bar 400 mm		

1119

3/4" Altı Köşe Havalı Lokma Anahtar (mm)
Impact Socket Wrench 6 Points (mm)

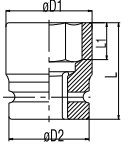

3/4"

Krom molibden, Fosfat kaplamalı
Chrom molybdenum, Phosphate finish

KOD CODE	mm	Ø D1 mm	Ø D2 mm	L mm	L1 mm	g	TL/Ad.
1119 06 7017	17	29	44	50	12	315	5 -----
1119 06 7019	19	32	44	50	13	330	5 35,21
1119 06 7021	21	35	44	50	15	340	5 35,21
1119 06 7022	22	36	44	50	15	345	5 35,21
1119 06 7023	23	37	44	50	16	350	5 -----
1119 06 7024	24	38	44	50	16	350	5 35,21
1119 06 7027	27	42	44	53	17	380	5 36,22
1119 06 7030	30	46	44	53	20	410	1 39,01
1119 06 7032	32	48	44	57	20	460	1 39,01
1119 06 7033	33	50	44	57	20	480	1 -----
1119 06 7034	34	51	44	57	22	490	1 50,94
1119 06 7035	35	52	44	57	22	500	1 -----
1119 06 7036	36	53	44	57	22	520	1 50,94
1119 06 7038	38	56	44	57	22	540	1 -----
1119 06 7041	41	59	44	58	24	580	1 78,62
1119 06 7046	46	66	44	62	24	715	1 83,59
1119 06 7050	50	71	54	65	26	955	1 -----

1519

3/4" Havalı Lokma Adaptörü
Impact Socket Adapter



3/4"

Krom molibden, Fosfat kaplamalı
Chrom molybdenum, Phosphate finish

KOD CODE	inch	g	TL/Ad.
1519 06 7011	3/4"Fx1/2"M	315	5 50,99
1519 06 7021	3/4"Fx1"M	345	5 -----



1519
3/4" Havalı Lokma Mafsal
Impact Socket Universal Joint

3/4"
Krom molibden, Fosfat kaplamalı
Chrom molybdenum, Phosphate finish

KOD CODE	L mm	g	□	TL/Ad.
1519 06 7108	108	735	5	139,78

1519
3/4" Havalı Lokma Ara Kol
Impact Socket Extension Bar

3/4"
Krom molibden, Fosfat kaplamalı
Chrom molybdenum, Phosphate finish

KOD CODE	L mm	g	□	TL/Ad.
1519 06 7175	175	865	5	101,51
1519 06 7250	250	1155	5	145,20
1519 06 7330	330	1425	5	181,53

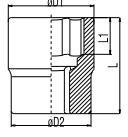
1225
1" Oniki Köşe Lokma Anahtar (mm)
Socket Wrench 12 Points (mm)

1"
Krom vanadyum, Krom kaplı, Polisajlı
Chrom vanadium, Chrom plated, Polished

KOD CODE	mm	Ø D1 mm	Ø D2 mm	L mm	L1 mm	g	□	TL/Ad.
1225 06 0035	35	50	48	63	26	360	1	-----
1225 06 0036	36	52	48	65	26	525	1	55,81
1225 06 0038	38	54	48	65	26	560	1	-----
1225 06 0041	41	58	50	70	29	665	1	60,85
1225 06 0046	46	65	54	75	32	900	1	73,77
1225 06 0050	50	70	57	75	34	1040	1	87,37
1225 06 0054	54	74	57	80	38	1145	1	-----
1225 06 0055	55	76	57	83	42	1250	1	102,11
1225 06 0058	58	79	57	83	42	1300	1	-----
1225 06 0060	60	82	60	87	46	1505	1	132,28
1225 06 0063	63	86	60	87	46	1555	1	-----
1225 06 0065	65	88	65	90	49	1670	1	-----
1225 06 0067	67	91	70	91	49	1670	1	-----
1225 06 0070	70	94	70	93	50	2100	1	-----
1225 06 0071	71	95	70	93	50	2070	1	-----
1225 06 0075	75	100	70	97	50	2310	1	-----
1225 06 0077	77	103	80	100	52	2555	1	-----
1225 06 0080	80	107	80	103	52	2580	1	-----

1525
1" Lokma Adaptörü
Adapter

TS ISO 1174 • DIN 3123

1"
Krom vanadyum, Krom kaplı, Polisajlı
Chrom vanadium, Chrom plated, Polished

KOD CODE	inch	g	□	TL/Ad.
1525 06 0005	1"Fx3/4"M	330	5	40,87

1525
1" Havalı Lokma Mafsal
Impact Socket Universal Joint

1"
Krom molibden, Fosfat kaplamalı
Chrom molybdenum, Phosphate finish

KOD CODE	L mm	g	□	TL/Ad.
1525 06 7128	128	1530	1	231,35

1125

1" Altı Köşe Havalı Lokma Anahtar (mm) Impact Socket Wrench 6 Points (mm)

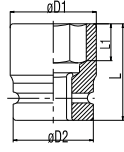

1"

Krom molibden, Fosfat kaplamalı
Chrom molybdenum, Phosphate finish

KOD CODE	mm	Ø D1 mm	Ø D2 mm	L mm	L1 mm	g	TL/Ad.
1125 06 7022	22	38	54	58	17	520	1
1125 06 7024	24	41	54	58	17	560	1
1125 06 7027	27	44	54	58	19	565	1
1125 06 7030	30	48	54	60	21	605	1
1125 06 7032	32	51	54	62	21	650	1
1125 06 7033	33	52	54	62	21	660	1
1125 06 7034	34	53	54	62	24	765	1
1125 06 7036	36	56	54	65	24	720	1
1125 06 7038	38	58	54	65	26	735	1
1125 06 7041	41	61	54	70	28	845	1
1125 06 7042	42	64	54	70	28	890	1
1125 06 7046	46	68	54	75	30	1075	1
1125 06 7050	50	73	54	75	32	1170	1
1125 06 7055	55	79	54	83	37	1435	1
1125 06 7060	60	86	54	87	37	1760	1
1125 06 7065	65	92	54	90	39	1760	1
1125 06 7070	70	97	54	93	39	2110	1
1125 06 7075	75	104	86	95	41	3190	1
1125 06 7080	80	110	86	95	43	3350	1

1525

1" Havalı Lokma Adaptörü Impact Socket Adapter



1"

Krom molibden, Fosfat kaplamalı
Chrom molybdenum, Phosphate finish

KOD CODE	inch	g	TL/Ad.
1525 06 7015	1"Fx3/4"M	560	5

1525

1" Havalı Lokma Ara Kol Impact Socket Extension Bar



1"

Krom molibden, Fosfat kaplamalı
Chrom molybdenum, Phosphate finish

KOD CODE	L mm	g	TL/Ad.
1525 06 7175	175	1395	5
1525 06 7250	250	1890	5
1525 06 7330	330	2455	5

1800

Kovan Anahtar İki Ağız (mm) Double Ended Tubular Socket Wrench (mm)

TS ISO 3793 • DIN 896

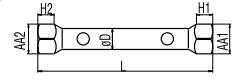

Dikişsiz çelik boru, Çinko kaplı
Seamless steel tube, Zinc plated.

KOD CODE	mm	L mm	AA1 mm	AA2 mm	H1 mm	H2 mm	Ø D mm	g	TL/Ad.
1800 07 0607	6x7	105	8.6	9.6	7	8	8	25	5
1800 07 0809	8x9	105	11.2	12.2	9	10	10	35	5
1800 07 1011	10x11	120	13.6	14.6	11	11.5	12	55	5
1800 07 1213	12x13	135	16	17	12	12.5	14	80	5
1800 07 1415	14x15	135	18.5	19.5	13	13.5	16	110	5
1800 07 1617	16x17	150	21	22	14	14.5	18	150	5
1800 07 1819	18x19	150	23	24	15	15.5	20	170	5
1800 07 2022	20x22	165	25.4	27.4	16	18	22	220	5
1800 07 2123	21x23	165	26.4	28.4	17	19	24	240	5
1800 07 2224	22x24	180	27.4	29.4	18	20	24	330	5
1800 07 2426	24x26	180	30.4	32.4	20	22	26	340	5
1800 07 2427	24x27	180	30.4	33.4	20	23	26	400	5
1800 07 2528	25x28	200	31.4	34.4	21	24	28	400	5
1800 07 2732	27x32	200	33.4	38.4	23	26	30	435	5

1850

Kovan Anahtar Mili Tommy Bar

TS ISO 3793 • DIN 900

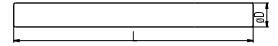

KOD CODE	ØDxL mm	g	TL/Ad.
1850 07 5125	5x125	20	10
1850 07 8180	8x180	70	10
1850 07 1120	10x120	75	10
1850 07 1200	10x200	120	10

1841

Kovan Anahtar Bir Ağız (mil dahil) Single Ended Tubular Socket Wrench with Handle Bar

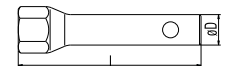

Dikişsiz çelik boru, Çinko kaplı
Seamless steel tube, Zinc plated.

KOD CODE	mm		L mm	ØD mm	Mil Handle bar mm	g	TL/Ad.
	mm	inch					
1841 07 0021	21	13/16"	120	20	10x120	215	5

1800

Kovan Anahtar Takımı İki Ağz (mil dahil, mm)
Double Ended Tubular Socket Wrench Set
with Handle Bars (mm)



KOD CODE	mm	g		TL/Ad.
1800 00 2106	6x7 - 8x9 - 10x11 12x13 - 14x15 - 16x17	525	6	136,26
1800 00 2108	6x7 - 8x9 - 10x11 12x13 - 14x15 - 16x17 18x19 - 20x22	920	8	195,87
1800 00 2110	6x7 - 8x9 - 10x11 12x13 - 14x15 - 16x17 18x19 - 20x22 - 21x23 24x26	1615	10	283,79
1800 00 2112	6x7 - 8x9 - 10x11 12x13 - 14x15 - 16x17 18x19 - 20x22 - 21x23 24x26 - 25x28 - 27x32	2445	12	399,55

1870

Ağır Tip Bijon Anahtarı İki Ağz Uzun
Double Ended Rim Wrench (long)

TSEK

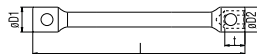

Yüksek alaşımlı çelik, Krom kaplı
Special steel, Chrom plated

KOD CODE	mm	L mm	t mm	øD1 mm	øD2 mm	g		TL/Ad.
1870 09 2224	22x24	400	34.5	34	36	1000	10	-----
1870 09 2227	22x27	400	34.5	34	40	1050	10	-----
1870 09 2427	24x27	400	34.5	36	40	1135	10	68,08
1870 09 2430	24x30	400	34.5	36	44	1250	10	-----
1870 09 2727	27x27	400	34.5	40	40	1170	10	-----
1870 09 2730	27x30	400	34.5	40	44	1380	10	73,07
1870 09 2732	27x32	400	34.5	40	46	1380	10	78,05
1870 09 3032	30x32	400	34.5	44	46	1380	10	80,93
1870 09 3233	32x33	400	34.5	46	47	1450	10	89,83

1874

Ağır Tip Bijon Anahtarı İki Ağz Kısa
Double Ended Rim Wrench with Handle Bar (short)

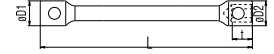

Yüksek alaşımlı çelik, Krom kaplı
Special steel, Chrom plated

KOD CODE	mm	L mm	t mm	øD1 mm	øD2 mm	g		TL/Ad.
1874 09 2224	22x24	170	34.5	34	36	720	10	39,52
1874 09 2427	24x27	200	34.5	36	40	800	10	44,94

1872

Ağır Tip Bijon Anahtarı Bir Ağz Uzun
Single Ended Rim Wrench with Handle Bar (long)

TSEK

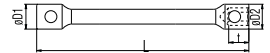

Yüksek alaşımlı çelik, Krom kaplı
Special steel, Chrom plated

KOD CODE	mm	L mm	t mm	øD1 mm	øD2 mm	g		TL/Ad.
1872 09 1735	17x35	450	30	36	50	1900	10	-----
1872 09 1938	19x38	450	34	40	54	1950	10	-----
1872 09 2138	21x38	450	34	40	54	1950	10	-----
1872 09 2141	21x41	450	34	40	56	2000	10	-----

1873

Ağır Tip Bijon Anahtarı Bir Ağz Kısa
Single Ended Rim Wrench with Handle Bar (short)

TSEK

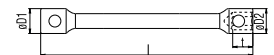

Yüksek alaşımlı çelik, Krom kaplı
Special steel, Chrom plated

KOD CODE	mm	L mm	t mm	øD1 mm	øD2 mm	g		TL/Ad.
1873 09 1735	17x35	300	30	36	50	1450	10	-----
1873 09 1941	19x41	300	34	40	56	1550	10	-----
1873 09 2141	21x41	300	34	40	56	1550	10	-----

1850

Bijon Anahtar Mili
Tommy Bar

TS ISO 3793 • DIN 900

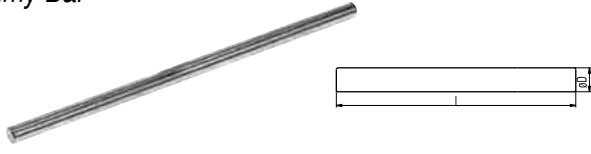

KOD CODE	ØDxL mm	g	TL/Ad.
1850 09 1630	18x630	1260	1 31,10

1940

Bijon Anahtarı Pipo Tipi (Tornavida Ağızlı)
Offset Socket Wrench with Screwdriver

TSEK

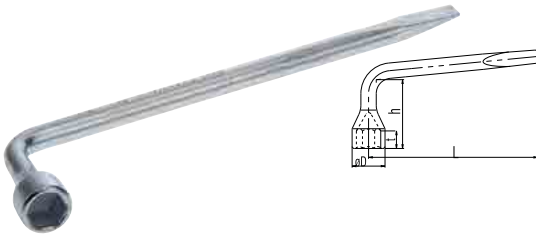

Yüksek alaşımli çelik, Krom kaplı
Special steel, Chrom plated

KOD CODE	mm	inch	L mm	ØD mm	h mm	t mm	g	TL/Ad.
1940 09 0017	17	11/16"	270	28	65	12	380	10 ----
1940 09 0019	19	3/4"	285	28	65	14	470	10 24,93
1940 09 0021	21	13/16"	320	30	85	16	575	10 30,82
1940 09 0022	22	7/8"	335	30	85	17	530	10 ----

1945

Bijon Anahtarı Pipo Tipi
Offset Socket Wrench

TSEK

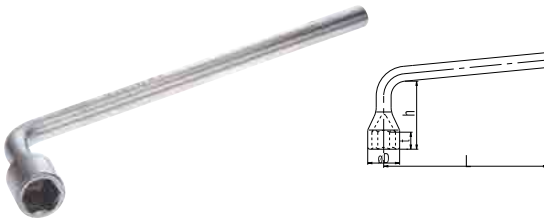

Yüksek alaşımli çelik, Krom kaplı
Special steel, Chrom plated

KOD CODE	mm	inch	L mm	ØD mm	h mm	t mm	g	TL/Ad.
1945 09 0023	23	29/32"	320	35	80	27	815	10 35,24
1945 09 0024	24	15/16"	320	36	80	27	825	10 ----
1945 09 0027	27	1 1/16"	425	40	100	34.5	1850	10 ----
1945 09 0030	30	1 3/16"	425	44	100	34.5	1875	10 ----
1945 09 0032	32	1 1/4"	425	46	100	34.5	1900	10 ----
1945 09 0033	33	1 5/16"	425	47	100	34.5	1925	10 ----
1945 09 0036	36	1 7/16"	630	50	100	36	2000	10 ----

1975

Bijon Anahtarı İstavroz Tipi
Cross Rim Wrench

TS ISO 6788

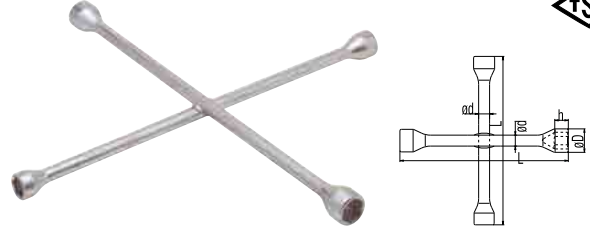

Yüksek alaşımli çelik, Krom kaplı
Special steel, Chrom plated

KOD CODE	mm	inch	ØD mm	h mm	L mm	Ød mm	g	TL/Ad.
1975 09 1719	17	11/16"	26	12	420	16	1422	10 54,23
	19	3/4"	28	14				
	21	13/16"	30	16				
	22	7/8"	32	17				

1975

1/2" Adaptörlü Bijon Anahtarı İstavroz Tipi
Cross Rim Wrench (with 1/2" adapter)

TS ISO 6788

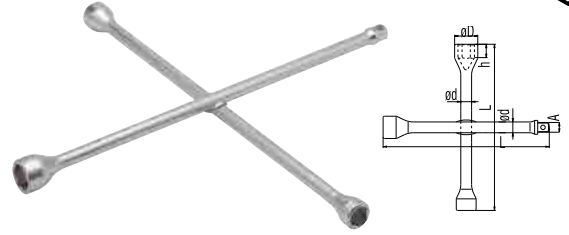

Yüksek alaşımli çelik, Krom kaplı
Special steel, Chrom plated

KOD CODE	mm	inch	ØD mm	h mm	L mm	A mm	Ød mm	g	TL/Ad.
1975 09 1322	17	11/16"	26	12	420	12.65	16	1375	10 53,43
	19	3/4"	28	14					
	22	7/8"	32	17					
		1/2"							

1959

T Tipi Bijon Anahtarı
Rim Wrench T - Handle

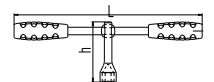

Yüksek alaşımli çelik, Çinko kaplı
Special steel, Zinc plated

KOD CODE	mm	L mm	h mm	g	TL/Ad.
1959 09 0019	19	350	110	645	10 ----

1845

Mafsallı Buji Lokma
Spark Plug Wrench with Universal Joint



Özel alaşım çelik, Krom kaplı
Special steel, Chrom plated

KOD CODE	mm	L mm	g	TL/Ad.
1845 08 0160	16	500	525	10 117,69
1845 08 0208	20.8	520	960	10 143,24

1855

Mafsallı T Kol Lokma
T - Handle Wrench with Universal Joint



Özel alaşım çelik, Krom kaplı
Special steel, Chrom plated

KOD CODE	mm	L mm	g	TL/Ad.
1855 08 0008	8	400	225	10 65,57
1855 08 0010	10	450	405	10 91,61
1855 08 0012	12	450	410	10 91,61
1855 08 0013	13	450	425	10 91,61
1855 08 0017	17	500	485	10 102,03
1855 08 0019	19	510	895	10 129,75

1857

T Kol Lokma
T - Handle Hexagonal Socket Wrench



Özel alaşım çelik, Krom kaplı
Special steel, Chrom plated

KOD CODE	mm	L mm	g	TL/Ad.
1857 08 0010	10	240	260	10 48,61
1857 08 0013	13	260	315	10 50,18
1857 08 0017	17	280	470	10 66,92
1857 08 0019	19	300	590	10 69,45

1610

3/8" Tork Anahtarı
Torque Wrench



KOD CODE	ÖLÇÜ SIZE	g	TL/Ad.
1610 06 0100	2.5 - 11 Nm - 0.3 - 1.2 Kg	515	1 489,50
1610 06 0300	5 - 33 Nm - 0.5 - 3.4 Kg	640	1 506,08

1613

1/2" Tork Anahtarı
Torque Wrench



KOD CODE	ÖLÇÜ SIZE	g	TL/Ad.
1613 06 1200	25 - 135 Nm - 3 - 14 Kg	1430	1 522,61
1613 06 2000	50 - 225 Nm - 5 - 23 Kg	2165	1 539,44
1613 06 3000	70 - 330 Nm - 7 - 35 Kg	2870	1 656,43





ÇEVRE YÖNETİM SİSTEMİ BELGESİ

ENVIRONMENTAL MANAGEMENT SYSTEM CERTIFICATE



TÜRK STANDARLARI ENSTİTÜSÜ
bu belge ile

İZELTAŞ İZMİR EL ALETLERİ SAN. VE TİC. A.Ş.
KEMALPAŞA CAD. NO:303 İŞIKKENT - BORNOVA
İZMİR / TÜRKİYE

koşullarında TS EN ISO 14001:2004 şartlarına uygun bir ÇEVRE
YÖNETİM SİSTEMİNE sahip olduğunu onaylar.

Belge kapsamı Ek'te verilmiştir



TURKISH STANDARDS INSTITUTION
hereby certifies that the organization

İZELTAŞ İZMİR EL ALETLERİ SAN. VE TİC. A.Ş.
KEMALPAŞA CAD. NO:303 İŞIKKENT - BORNOVA
İZMİR / TÜRKİYE

has an ENVIRONMENTAL MANAGEMENT SYSTEM
which fulfills the requirements of the TS EN ISO
14001:2004

Scope of the certificate is given in annex

Belge No / Certificate No	CY-592/09
Belge Tarihi / Date of Certificate	12.11.2015
Geçerlilik Tarihi / Valid Until	12.11.2018
Revizyon Tarihi / Date of Revision	12.11.2015
İlk Belge Tarihi / Initial Certification Date	26.10.2009

The certificate is valid provided that compliance
with the certification requirement is maintained

TÜRK STANDARLARI ENSTİTÜSÜ

TURKISH STANDARDS INSTITUTION

İzmir Belgelendirme Müdürü
İzmir Certification Director

Ahmet NAMLI

Türk Standartları Enstitüsü Türk Akreditasyon Kurumu TÜRKAK tarafından akredite edilmiştir.
Turkish Standards Institution, has been accredited by the Turkish Accreditation Agency TÜRKAK.

Bu belge, belgelendirme şartlarına
uygunluk sağlandığı sürece geçerlidir.

351911201509311871

Boru Anahtarları ve Penseler

3

Pipe Wrenches and Pliers

*Boru Anahtarları
Ford Penseler
Ayarlı Penseler
Penseler
Kerpetenler
Elektronikçi Penseler*

*Pipe Wrenches
Water Pump Pliers
Grip Wrenches
Pliers
Carpenter Pincers
Electronic Pliers*

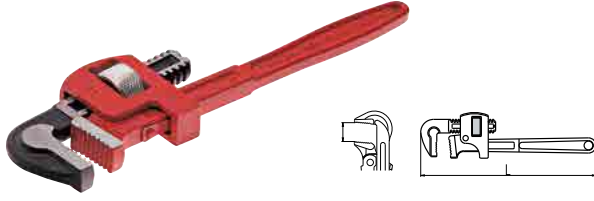

2100
Stilson Boru Anahtarı
Pipe Wrench, Stilson

Krom vanadyum, Dişler indüksiyonda sertleştirilmiş, Elektrostatik boyanmış
Chrom vanadium, Teeth induction hardened, Electrostatically painted

KOD CODE	L mm	L inch	mm	ÖLÇÜ SIZE Inch	g	TL/Ad.
2100 10 0008	200	8"	27	3/4"	280	1 58,58
2100 10 0010	250	10"	34	1"	550	1 81,53
2100 10 0012	300	12"	42	1 1/4"	725	1 91,73
2100 10 0014	350	14"	50	1 1/2"	1030	1 109,53
2100 10 0018	450	18"	60	2"	1775	1 148,95
2100 10 0024	600	24"	76	2 1/2"	2775	1 240,98
2100 10 0036	900	36"	100	3 1/2"	6000	1 -----

2100
Çene
Jaw

KOD CODE	ÖLÇÜ FOR	g	TL/Ad.
2100 10 0108	8"	80	5 19,06
2100 10 0110	10"	180	5 28,30
2100 10 0112	12"	320	5 31,55
2100 10 0114	14"	400	5 38,06
2100 10 0118	18"	575	5 51,23
2100 10 0124	24"	980	5 73,43
2100 10 0136	36"	1900	5 -----

2100
Bağlantı Parçası
Connection Part

KOD CODE	ÖLÇÜ FOR	g	TL/Ad.
2100 10 0208	8"	60	5 14,64
2100 10 0210	10"	95	5 21,74
2100 10 0212	12"	100	5 23,82
2100 10 0214	14"	195	5 28,78
2100 10 0218	18"	345	5 39,29
2100 10 0224	24"	445	5 59,08
2100 10 0236	36"	650	5 -----

2100
Somun
Nut

KOD CODE	ÖLÇÜ FOR	g	TL/Ad.
2100 10 0308	8"	10	5 5,20
2100 10 0310	10"	30	5 7,45
2100 10 0312	12"	25	5 8,26
2100 10 0314	14"	45	5 9,94
2100 10 0318	18"	75	5 13,02
2100 10 0324	24"	105	5 20,25
2100 10 0336	36"	300	5 -----

2110
Ağır Tip Boru Anahtarı
Pipe Wrench, Heavy Duty

Krom vanadyum, Dişler indüksiyonda sertleştirilmiş, Elektrostatik boyanmış
Chrom vanadium, Teeth induction hardened, Electrostatically painted

KOD CODE	L mm	L inch	mm	ÖLÇÜ SIZE Inch	g	TL/Ad.
2110 10 0008	200	8"	34	1"	425	1 66,83
2110 10 0010	250	10"	42	1 1/4"	795	1 87,26
2110 10 0012	300	12"	50	1 1/2"	1245	1 101,65
2110 10 0014	350	14"	60	2"	1710	1 116,51
2110 10 0018	450	18"	75	2 1/2"	2685	1 165,20
2110 10 0024	600	24"	90	3"	4370	1 261,76
2110 10 0036	900	36"	140	5"	7600	1 590,33
2110 10 0048	1200	48"	165	6"	15600	1 1095,22

2110
Çene
Jaw

KOD CODE	ÖLÇÜ FOR	g	TL/Ad.
2110 10 0108	8"	100	5 22,84
2110 10 0110	10"	205	5 29,83
2110 10 0112	12"	235	5 36,82
2110 10 0114	14"	400	5 43,15
2110 10 0118	18"	675	5 67,32
2110 10 0124	24"	900	5 104,45
2110 10 0136	36"	1820	5 198,99
2110 10 0148	48"	3410	5 291,86

2110

Somun
Nut



KOD CODE	ÖLÇÜ FOR	g		TL/Ad.
2110 10 0308	8"	10	5	8,11
2110 10 0310	10"	25	5	8,79
2110 10 0312	12"	35	5	9,76
2110 10 0314	14"	40	5	11,28
2110 10 0318	18"	65	5	16,10
2110 10 0324	24"	115	5	24,20
2110 10 0336	36"	230	5	45,21
2110 10 0348	48"	305	5	62,56

2200

Maşalı Boru Anahtarı (45°)
Pipe Wrench (45°)

DIN 5234

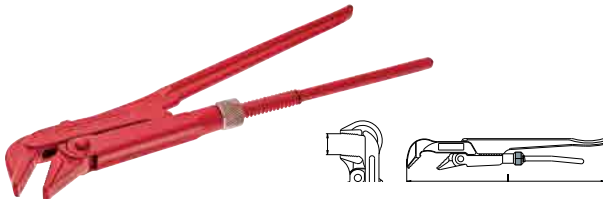

Krom vanadyum, Dişler induksiyonda sertleştirilmiş, Elektrostatik boyanmış
Chrom vanadium, Teeth induction hardened, Electrostatically painted

KOD CODE	L mm	mm	ÖLÇÜ SIZE Inch	g		TL/Ad.
2200 10 0005	255	22	1/2"	385	1	90,39
2200 10 0010	335	35	1"	720	1	107,40
2200 10 0015	470	46	1 1/2"	1345	1	151,71
2200 10 0020	630	65	2"	2470	1	241,66

2201

Maşalı Boru Anahtarı (85°)
Pipe Wrench (85°)

TS 3796

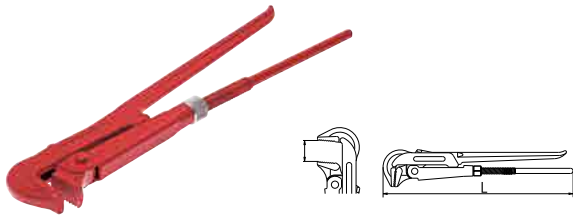

Krom vanadyum, Dişler induksiyonda sertleştirilmiş, Elektrostatik boyanmış
Chrom vanadium, Teeth induction hardened, Electrostatically painted

KOD CODE	L mm	mm	ÖLÇÜ SIZE Inch	g		TL/Ad.
2201 10 0010	325	40	1"	870	1	79,09
2201 10 0015	430	60	1 1/2"	1585	1	122,54
2201 10 0020	585	70	2"	2700	1	183,58
2201 10 0030	690	100	3"	4270	1	278,30
2201 10 0040	760	130	4"	5800	1	417,45

2200 - 2201

Somun
Nut



KOD CODE	ÖLÇÜ FOR	g		TL/Ad.
2201 10 0110	1"	25	10	4,19
2201 10 0115	1 1/2"	40	10	5,31
2201 10 0120	2"	60	10	7,02
2201 10 0130	3"	75	10	9,45
2201 10 0140	4"	75	10	11,15

2202

İsveç Tip Maşalı Boru Anahtarı
Pipe Wrench, Swedish Pattern

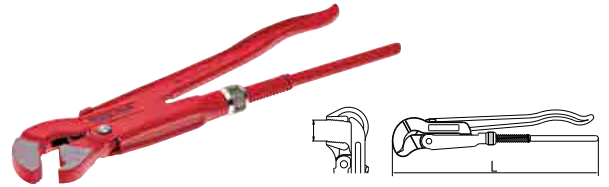

Krom vanadyum, Dişler induksiyonda sertleştirilmiş, Elektrostatik boyanmış
Chrom vanadium, Teeth induction hardened, Electrostatically painted

KOD CODE	L mm	mm	ÖLÇÜ SIZE Inch	g		TL/Ad.
2202 10 0010	320	40	1"	845	1	109,16
2202 10 0015	410	60	1 1/2"	1465	1	157,87
2202 10 0020	535	70	2"	2345	1	243,47
2202 10 0030	700	100	3"	4200	1	-----

2300

Zincirli Boru Anahtarı
Chain Pipe Wrench Heavy Duty

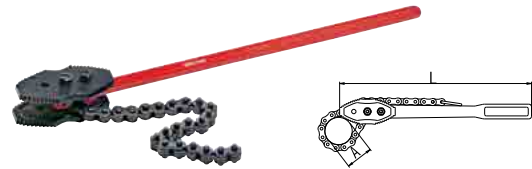

Özel alaşımli çelik, Dişler induksiyonda sertleştirilmiş, Elektrostatik boyanmış
Special steel, Teeth induction hardened, Electrostatically painted

KOD CODE	L mm	A mm	A inch	g		TL/Ad.
2300 10 0015	350	50	1 1/2"	1345	1	186,67
2300 10 0025	685	75	2 1/2"	3500	1	331,21
2300 10 0040	940	115	4"	6700	1	470,79
2300 10 0060	1125	165	6"	12600	1	933,31
2300 10 0080	1280	220	8"	17165	1	1205,89
2300 10 0120	1625	325	12"	24400	1	2213,53

2300

Zincir
Chain



KOD CODE	ÖLÇÜ FOR	g		TL/Ad.
2300 10 1015	1 1/2"	240	1	70,83
2300 10 1025	2 1/2"	400	1	113,53
2300 10 1040	4"	600	1	149,88
2300 10 1060	6"	2610	1	400,60
2300 10 1080	8"	3285	1	499,14
2300 10 1120	12"	4625	1	741,64

2400

Üniversal Fort Pense
Waterpump Pliers Universal

TS 60 • DIN ISO 8976



Krom vanadyum, Krom kaplı, PVC izoleli
Chrom vanadium, Chrom plated, PVC insulated

KOD CODE	L mm	L inch	mm	g		TL/Ad.
2400 11 0160	160	6 1/4"	30	125	5	52,17
2400 11 0240	240	9 1/2"	35	355	5	66,98
2400 11 0315	315	12 1/2"	40	530	5	125,00

2400

Süper İzoleli Üniversal Fort Pense
Waterpump Pliers Universal Super insulated

TS 60 • DIN ISO 8976



Krom vanadyum, Krom kaplı, Kalın PVC izoleli
Chrom plated, Chrom vanadium, Double PVC insulated

KOD CODE	L mm	L inch	mm	g		TL/Ad.
2400 11 1240	240	9 1/2"	35	435	5	78,93

2405

Standart Fort Pense
Waterpump Pliers Standard

TS 60 • DIN ISO 8976

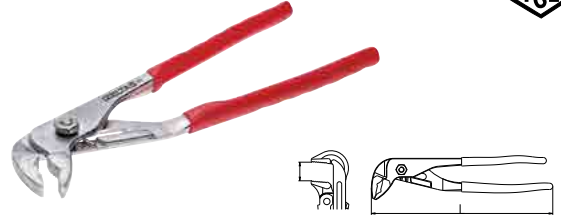

Krom vanadyum, Krom kaplı, PVC izoleli
Chrom vanadium, Chrom plated, PVC insulated

KOD CODE	L mm	L inch	mm	g		TL/Ad.
2405 11 0160	160	6 1/4"	24	125	5	-----
2405 11 0240	240	9 1/2"	30	295	5	-----
2405 11 0315	315	12 1/2"	50	525	5	-----

2410

Special Fort Pense
Waterpump Pliers Special

TS 60 • DIN ISO 8976



Krom vanadyum, Elektrostatik boyanmış
Chrom vanadium, Electrostatically painted

KOD CODE	L mm	L inch	mm	g		TL/Ad.
2410 11 0160	160	6 1/4"	30	160	5	-----
2410 11 0240	240	9 1/2"	35	270	5	-----
2410 11 0315	315	12 1/2"	40	450	5	-----

2415

Yaylı Fort Pense
Waterpump Pliers With Spring

TS 60 • DIN ISO 8976



Krom vanadyum, Krom kaplı, PVC izoleli
Chrom vanadium, Chrom plated, PVC insulated

KOD CODE	L mm	L inch	mm	g		TL/Ad.
2415 11 0240	240	6 1/4"	30	160	5	-----

2500

Üniversal Ayarlı Pense Universal Grip



TSEK

Çeneler krom vanadyum çeliğinden dövülmüştür, Nikel kaplama,
Kullanım sahası: Yuvarlak ve düz malzemeler
Jaws Chrom vanadium forged, Nickel plated
Application field : Flat and round materials

KOD CODE	L mm	L inch	mm	g		TL/Ad.
2500 11 0250	250	10"	30	560	5	82,35

2511

C tipi Ayarlı Pense C Clamp Grip

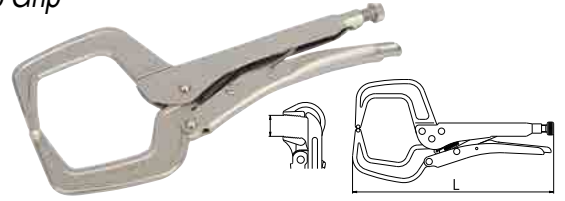

Çeneler krom vanadyum çeliğinden dövülmüştür, Nikel kaplama,
Kullanım sahası : Açılı profillerin tutulmasında
Jaws Chrom vanadium forged, Nickel plated
Application field : For Gripping angled sheet metal

KOD CODE	L mm	L inch	mm	g		TL/Ad.
2511 11 0280	280	11"	70	700	1	110,79

2505

Standart Ayarlı Pense Standard Grip

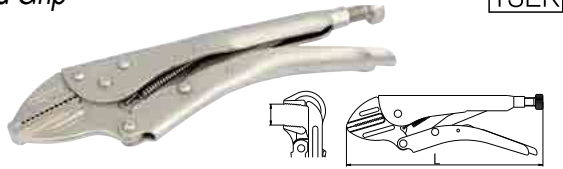

TSEK

Çeneler krom vanadyum çeliğinden dövülmüştür, Nikel kaplama
Kullanım sahası: Düz malzemeler
Jaws, Chrom vanadium forged, Nickel plated
Application field : Flat materials

KOD CODE	L mm	L inch	mm	g		TL/Ad.
2505 11 0250	250	10"	30	535	5	82,35

2512

Kaynakçı Ayarlı Pense (Düz Ağız) Lock Grip With Flat Jaws



Özel alaşımli çelikten imal edilmiş, Nikel kaplama,
Kullanım sahası : 80 mm düz çeneleri ile kıvrık metal levhaları
Made from special alloy steel, Nickel plated, Application field :
Gripping sheet metals with 80mm Flat jaws

KOD CODE	L mm	L inch	mm	g		TL/Ad.
2512 11 0200	200	8"	30	485	1	107,72

2510

Special Ayarlı Pense Special Grip

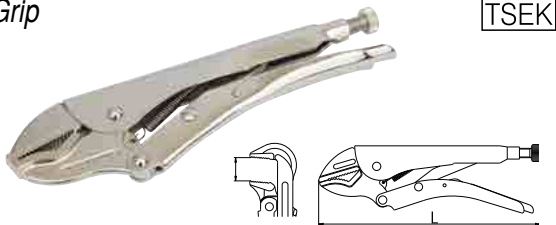

TSEK

Çeneler krom vanadyum çeliğinden dövülmüştür, Nikel kaplama,
Kullanım sahası: Yuvarlak ve düz malzemeler
Jaws Chrom vanadium forged, Nickel plated
Application field : Flat and round materials

KOD CODE	L mm	L inch	mm	g		TL/Ad.
2510 11 0250	250	10"	30	550	5	82,35

2513

Kaynakçı Ayarlı Pense (Boru İçin) Grip For Tubes

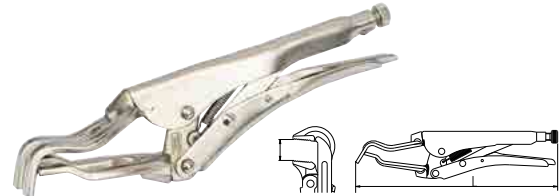

Özel alaşımli çelikten imal edilmiş, Nikel kaplama,
Kullanım sahası : Boru malzemeler
Made from special alloy steel, Nickel plated, Application field : Tubes

KOD CODE	L mm	L inch	mm	g		TL/Ad.
2513 11 0280	280	11"	50	800	1	107,72

2515

Kaportacı Ayarlı Pense
Welding Grip

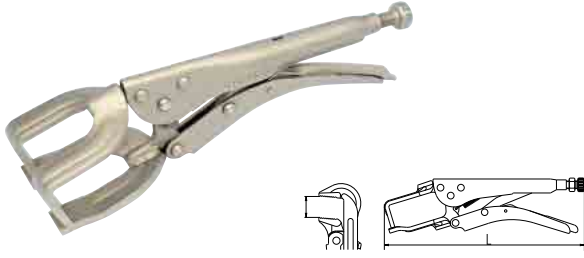

Özel alaşımlı çelikten imal edilmiş- Nikel kaplama,
Kullanım sahası : Yassı ve köşeli malzemelerde
Made from special alloy steel, Nickel plated
Application field : Angled corners and edges

KOD CODE	L mm	L inch	FAİL mm	g	TL/Ad.
2515 11 0270	270	10 5/8"	50	765	1 110,33

3020

Kombine Pense Opak
Combination Pliers

TS 60 • TS 11068 • DIN ISO 5744
DIN ISO 5746



Özel alaşımlı çelik, Kesici ağızlar indüksiyonda sertleştirilmiş,
Special steel, Cutters induction hardened,

KOD CODE	L mm	L inch	MODEL	g	TL/Ad.
3020 12 2160	160	6 1/4"	OPAK	205	5 47,40
3020 12 2180	180	7 1/8"	OPAK	275	5 54,00
3020 12 2200	200	8"	OPAK	315	5 60,60

3020

180mm Kombine Pense Opak
Mini Satış Standı
180mm Combination Pliers
Opaque Mini Display Frame



KOD CODE	L mm	L inch	MODEL	g	TL/Ad.
3020 00 2180	180	7 1/8"	OPAK	4125	15 810,00

3020

Kombine Pense Kraft
Combination Pliers

TS 60 • TS 11068 • DIN ISO 5744
DIN ISO 5746



Özel alaşımlı çelik, Kesici ağızlar indüksiyonda sertleştirilmiş,
Krom kaplı, *Special steel, Cutters induction hardened,*
Chrom plated,

KOD CODE	L mm	L inch	MODEL	g	TL/Ad.
3020 12 3160	160	6 1/4"	KRAFT	225	5 58,54
3020 12 3180	180	7 1/8"	KRAFT	285	5 64,98
3020 12 3200	200	8"	KRAFT	380	5 72,99



3020

Kombine Pense Rod Combination Pliers

TS 60 • TS 11068 • DIN ISO 5744
DIN ISO 5746



1000 V
E DIN EN 60900:2005



Özel alaşımli çelik, Kesici ağızlar indüksiyonda sertleştirilmiş,
Krom kaplı, *Special steel, Cutters induction hardened,
Chrom plated,*

KOD CODE	L mm	L inch	MODEL	g	TL/Ad.
3020 12 4160	160	6 1/4"	ROD - TUV GS	230	5 53,85
3020 12 4180	180	7 1/8"	ROD - TUV GS	285	5 61,34
3020 12 4200	200	8"	ROD - TUV GS	380	5 68,86

3020

Kombine Pense Ergonomik Combination Pliers

TS 60 • TS 11068 • DIN ISO 5744
DIN ISO 5746



Özel alaşımli çelik, Kesici ağızlar indüksiyonda sertleştirilmiş,
Krom kaplı, *Special steel, Cutters induction hardened,
Chrom plated,*

KOD CODE	L mm	L inch	MODEL	g	TL/Ad.
3020 12 5160	160	6 1/4"	ERGONOMİK	205	5 59,26
3020 12 5180	180	7 1/8"	ERGONOMİK	260	5 67,46
3020 12 5200	200	8"	ERGONOMİK	345	5 75,77

3020

Süper İzole Kombine Pense Combination Pliers Super Insulated

TS 60 • TS 11068 • DIN ISO 5744



1000 V
E DIN EN 60900:2005



Özel alaşımli çelik, Kesici ağızlar indüksiyonda sertleştirilmiş,
Krom kaplı, Kalın PVC izoleli
*Special steel, Cutters induction hardened,
Chrom plated, triple PVC insulated*

KOD CODE	L mm	L inch	g	TL/Ad.
3020 12 0180	180	7 1/8"	315	5 78,98
3020 12 0200	200	8"	445	5 89,97

3030

Kombine Pense Ağır Tip (çelik tel için) Combination Pliers (Opaque) Heavy Duty (for piano wire)

TS 60 • TS 11068 • DIN ISO 5744



Özel alaşımli çelik, Kesici ağızlar indüksiyonda sertleştirilmiş,
Krom kaplı
*Special steel, Cutters induction hardened,
Chrom plated*

KOD CODE	L mm	L inch	g	TL/Ad.
3030 12 2160	160	6 1/4"	225	5 -----
3030 12 2180	180	7 1/8"	285	5 68,24
3030 12 2200	200	8"	380	5 -----



3050

Standart Pense
Standard Pliers

TS 60 • TS 11068 • DIN 5744



Özel alaşımli çelik, Kesici ağızlar indüksiyonda sertleştirilmiş,
Krom kaplı, PVC saplı
Special steel, Cutters induction hardened, Chrom plated, PVC handle

KOD CODE	L mm	L inch	MODEL	g	TL/Ad.
3050 12 0160	160	6 1/4"	OPAK	220	39,41
3050 12 0180	180	7 1/8"	OPAK	280	45,09
3050 12 0200	200	8"	OPAK	370	58,95

3110

Amerikan Pense
Slip Joint Pliers

TS 60



Özel alaşımli çelik, Krom kaplı
Special steel, Chrom vanadyum

KOD CODE	L mm	L inch	g	TL/Ad.
3110 12 0200	200	8"	260	-----
3110 12 0250	250	10"	400	75,94

3220

Uzun Kargaburun Düz Uçlu Opak
Long Nose Pliers (Flat)

TS 60 • TS 11067



Özel alaşımli çelik, Kesici ağızlar indüksiyonda sertleştirilmiş,
Special steel, Cutters induction hardened,

KOD CODE	L mm	L inch	MODEL	g	TL/Ad.
3220 13 2140	140	5 1/2"	OPAK	110	48,74
3220 13 2160	160	6 1/4"	OPAK	135	54,65
3220 13 2180	180	7 1/8"	OPAK	170	59,62
3220 13 2200	200	8"	OPAK	205	63,68

3220

Uzun Kargaburun Düz Uçlu Kraft
Long Nose Pliers (Flat)

TS 60 • TS 11067



Özel alaşımli çelik, Kesici ağızlar indüksiyonda sertleştirilmiş,
Krom kaplı
Special steel, Cutters induction hardened,
Chrom plated

KOD CODE	L mm	L inch	MODEL	g	TL/Ad.
3220 13 3140	140	5 1/2"	KRAFT	120	58,70
3220 13 3160	160	6 1/4"	KRAFT	155	65,80
3220 13 3180	180	7 1/8"	KRAFT	185	71,39
3220 13 3200	200	8"	KRAFT	210	76,69



3220

Uzun Kargaburun Düz Uçlu Rod Long Nose Pliers (Flat)

TS 60 • TS 11067



△ 1000 V
E DIN EN 60900:2005



Özel alaşımli çelik, Kesici ağızlar indüksiyonda sertleştirilmiş,
Krom kaplı
Special steel, Cutters induction hardened,
Chrom plated

KOD CODE	L mm	L inch	MODEL	g	□	TL/Ad.
3220 13 4140	140	5 1/2"	ROD - TUV GS	120	5	55,39
3220 13 4160	160	6 1/4"	ROD - TUV GS	160	5	62,10
3220 13 4180	180	7 1/8"	ROD - TUV GS	185	5	67,35
3220 13 4200	200	8"	ROD - TUV GS	195	5	72,37

3220

Süper izole Uzun Kargaburun Düz Uçlu Long Nose Pliers Flat, Super Insulated

TS 60 • DIN 5236



△ 1000 V
E DIN EN 60900:2005



Özel alaşımli çelik, Kesici ağızlar indüksiyonda sertleştirilmiş,
Krom kaplı, Kalın PVC izoleli
Special steel, Cutters induction hardened,
Chrom plated, triple PVC insulated

KOD CODE	L mm	L inch	g	□	TL/Ad.
3220 13 0200	200	8"	230	5	90,19

3220

Uzun Kargaburun Düz Uçlu Ergonomik Nose Pliers (Flat)

TS 60 • TS 11067



Özel alaşımli çelik, Kesici ağızlar indüksiyonda sertleştirilmiş,
Krom kaplı
Special steel, Cutters induction hardened,
Chrom plated

KOD CODE	L mm	L inch	MODEL	g	□	TL/Ad.
3220 13 5140	140	5 1/2"	ERGONOMİK	110	5	60,91
3220 13 5160	160	6 1/4"	ERGONOMİK	140	5	68,31
3220 13 5180	180	7 1/8"	ERGONOMİK	160	5	74,09
3220 13 5200	200	8"	ERGONOMİK	170	5	79,60

3225

Uzun Kargaburun Eğri Uçlu Opak Long Nose Pliers (Bent)

TS 60 • TS 11067



Özel alaşımli çelik, Kesici ağızlar indüksiyonda sertleştirilmiş,
Special steel, Cutters induction hardened,

KOD CODE	L mm	L inch	MODEL	g	□	TL/Ad.
3225 13 2140	140	5 1/2"	OPAK	125	5	-----
3225 13 2160	160	6 1/4"	OPAK	140	5	58,37
3225 13 2180	180	7 1/8"	OPAK	170	5	66,83
3225 13 2200	200	8"	OPAK	175	5	71,39



3225

Uzun Kargaburun Eğri Uçlu Kraft
Long Nose Pliers (Bent)

TS 60 • TS 11067



Özel alaşımli çelik, Kesici ağızlar indüksiyonda sertleştirilmiş,
Krom kaplı
Special steel, Cutters induction hardened,
Chrom plated

KOD CODE	L mm	L inch	MODEL	g	TL/Ad.
3225 13 3140	140	5 1/2"	KRAFT	120	5
3225 13 3160	160	6 1/4"	KRAFT	150	5
3225 13 3180	180	7 1/8"	KRAFT	190	5
3225 13 3200	200	8"	KRAFT	195	5

3225

Uzun Kargaburun Eğri Uçlu Ergonomik
Long Nose Pliers (Bent)

TS 60 • TS 11067



Özel alaşımli çelik, Kesici ağızlar indüksiyonda sertleştirilmiş,
Krom kaplı
Special steel, Cutters induction hardened,
Chrom plated

KOD CODE	L mm	L inch	MODEL	g	TL/Ad.
3225 13 5140	140	5 1/2"	ERGONOMİK	110	5
3225 13 5160	160	6 1/4"	ERGONOMİK	140	5
3225 13 5180	180	7 1/8"	ERGONOMİK	160	5
3225 13 5200	200	8"	ERGONOMİK	170	5

3225

Uzun Kargaburun Eğri Uçlu Rod
Long Nose Pliers (Bent)

TS 60 • TS 11067



Özel alaşımli çelik, Kesici ağızlar indüksiyonda sertleştirilmiş,
Krom kaplı
Special steel, Cutters induction hardened,
Chrom plated

KOD CODE	L mm	L inch	MODEL	g	TL/Ad.
3225 13 4140	140	5 1/2"	ROD	160	5
3225 13 4160	160	6 1/4"	ROD - TUV GS	160	5
3225 13 4180	180	7 1/8"	ROD - TUV GS	190	5
3225 13 4200	200	8"	ROD - TUV GS	190	5

3225

Süper İzole Uzun Kargaburun Eğri Uçlu
Long Nose Bent, Super Insulated

TS 60 • DIN 5236



1000 V
E DIN EN 60900:2005



Özel alaşımli çelik, Kesici ağızlar indüksiyonda sertleştirilmiş,
Krom kaplı, Kalın PVC izoleli
Special steel, Cutters induction hardened, Chrom plated,
triple PVC insulated

KOD CODE	L mm	L inch	g	TL/Ad.
3225 13 0200	200	8"	230	5



3300

Çakma Uçlu Dış Segman Pense (Düz)
Circlip Pliers,
External Driven Tips (Flat)

TS 60 • DIN 5254



Krom vanadyum, Siyah oksit kaplı, PVC izoleli
Chrom vanadium, Black finish, PVC insulated

KOD CODE	L mm	⌀	g	□	TL/Ad.
3300 12 0140	140	10 - 25	90	5	58,47
3300 12 0180	180	19 - 60	195	5	61,55
3300 12 0225	225	40 - 100	235	5	77,00
3300 12 0295	295	85 - 165	445	5	130,58

3311

Dış Segman Pense (Yaylı Eğri)
Circlip Pliers, External (Bent)

TS 60 • DIN 5254



Krom vanadyum, Krom kaplı, PVC izoleli
Chrom vanadium, Chrom plated, PVC insulated

KOD CODE	L mm	⌀	g	□	TL/Ad.
3311 12 0125	125	10 - 25	105	5	62,15
3311 12 0170	170	19 - 60	190	5	65,47
3311 12 0210	210	40 - 100	250	5	69,36
3311 12 0275	275	85 - 165	445	5	130,76

3301

Dış Segman Pense (Yaylı Düz)
Circlip Pliers, External (Flat)

TS 60 • DIN 5254



Krom vanadyum, Krom kaplı, PVC izoleli
Chrom vanadium, Chrom plated, PVC insulated

KOD CODE	L mm	⌀	g	□	TL/Ad.
3301 12 0140	140	10 - 25	90	5	55,66
3301 12 0180	180	19 - 60	195	5	58,60
3301 12 0225	225	40 - 100	235	5	73,33
3301 12 0295	295	85 - 165	445	5	124,37

3320

Çakma Uçlu İç Segman Pense (Düz)
Circlip Pliers, Inside Driven Tips (Flat)

TS 60 • DIN 5254



Krom vanadyum, Siyah oksit kaplı, PVC izoleli
Chrom vanadium, Black finish, PVC insulated

KOD CODE	L mm	⌀	g	□	TL/Ad.
3320 12 0140	140	8 - 25	100	5	53,75
3320 12 0180	180	19 - 60	185	5	56,72
3320 12 0225	225	40 - 100	250	5	70,69
3320 12 0310	310	85 - 165	445	5	121,31

3310

Çakma Uçlu Dış Segman Pense (Eğri)
Circlip Pliers, External (Flat)

TS 60 • DIN 5254



Krom vanadyum, Siyah oksit kaplı, PVC izoleli
Chrom vanadium, Black finish, PVC insulated

KOD CODE	L mm	⌀	g	□	TL/Ad.
3310 12 0125	125	10 - 25	105	5	65,26
3310 12 0170	170	19 - 60	190	5	68,75
3310 12 0210	210	40 - 100	250	5	85,76
3310 12 0275	275	85 - 165	445	5	137,29

3321

İç Segman Pensi (Yaysız Düz)
Circlip Pliers Internal (Flat)

TS 60 • DIN 5256



Krom vanadyum, Krom kaplı, PVC izoleli
Chrom vanadium, Chrom plated, PVC insulated

KOD CODE	L mm	⌀	g	□	TL/Ad.
3321 12 0140	140	8 - 25	100	5	51,18
3321 12 0180	180	19 - 60	185	5	54,00
3321 12 0225	225	40 - 100	250	5	67,32
3321 12 0310	310	85 - 165	445	5	115,52

3330

Çakma Uçlu İç Segman Pense (Eğri)
Circlip Pliers,
Inside Driven Tips (Bend)

TS 60 • DIN 5254



Krom vanadyum, Siyah oksit kaplı, PVC izoleli
Chrom vanadium, Black finish, PVC insulate

KOD CODE	L mm	ÖLÇÜ	g	TL/Ad.
3330 12 0130	130	8 - 25	105	57,81
3330 12 0170	170	19 - 60	185	60,86
3330 12 0210	210	40 - 100	250	75,97
3330 12 0290	290	85 - 165	440	130,52

3331

İç Segman Pensi (Yaysız Eğri)
Circlip Pliers Internal (Bent)

TS 60 • DIN 5256



Krom vanadyum, Krom kaplı, PVC izoleli
Chrom vanadium, Chrom plated, PVC insulated

KOD CODE	L mm	ÖLÇÜ	g	TL/Ad.
3331 12 0130	130	8 - 25	105	55,04
3331 12 0170	170	19 - 60	185	57,96
3331 12 0210	210	40 - 100	250	72,33
3331 12 0290	290	85 - 165	440	124,29

3400

Sübap Segman Pensi
Pliers for valve seals



KOD CODE	L mm	L inch	g	TL/Ad.
3400 12 0275	275	11"	350	116,25

3405

Piston Segman Pense
Piston ring pliers



KOD CODE	L mm	ÖLÇÜ	g	TL/Ad.
3405 12 0225	265	Ø60 - Ø160	200	81,24

3410

Piston Yay Pensesi
Piston spring pliers



KOD CODE	L mm	ÖLÇÜ	g	TL/Ad.
3410 12 0210	210	Ø30 - Ø60	160	-----

3415

Fren Yay Pensesi
Brake spring pliers



Krom vanadyum, Krom kaplı
Chrom vanadium, Chrom plated

KOD CODE	L mm	L inch	g	TL/Ad.
3415 12 0320	320	13"	430	115,26
3415 12 0525	525	20"	1190	266,86

3420

Hortum Kelepçe Pensesi
Hose clamp pliers



KOD CODE	L mm	L inch	g		TL/Ad.
3420 12 0220	220	8 3/4"	185	5	75,44

3425

Hortum Kelepçe Pensesi (Sıkıştırma Tipi)
Hose clamp pliers



KOD CODE	L mm	L inch	g		TL/Ad.
3425 12 0220	235	9 1/4"	355	5	77,28

3700

Yan Keski Opak
Side Cutting Pliers

TS 60 • DIN ISO 5749



Özel alaşımli çelik, Kesici ağızlar indüksiyonda sertleştirilmiş,
Special steel, Cutters induction hardened,

KOD CODE	L mm	L inch	MODEL	g		TL/Ad.
3700 16 2140	140	5 1/2"	OPAK	165	5	50,09
3700 16 2160	160	6 1/4"	OPAK	230	5	60,21
3700 16 2180	180	7 1/8"	OPAK	230	5	70,26

3700

160mm Yan Keski Opak
Mini Satış Standı
Side Cutting Pliers
160mm Opaque Mini Display Frame



KOD CODE	L mm	L inch	MODEL	g		TL/Ad.
3700 00 2160	160	6 1/4"	OPAK	3450	15	903,15

3700

Yan Keski Kraft
Side Cutting Pliers

TS 60 • DIN ISO 5749



Özel alaşımli çelik, Kesici ağızlar indüksiyonda sertleştirilmiş,
Krom kaplı Special steel, Cutters induction hardened,
Chrom plated

KOD CODE	L mm	L inch	MODEL	g		TL/Ad.
3700 16 3140	140	5 1/2"	KRAFT	190	5	60,36
3700 16 3160	160	6 1/4"	KRAFT	240	5	72,48
3700 16 3180	180	7 1/8"	KRAFT	255	5	84,52

3700

Yan Keski Rod
Side Cutting Pliers

TS 60 • DIN ISO 5749



⚡ 1000 V
E DIN EN 60900:2005



Özel alaşımli çelik, Kesici ağızlar indüksiyonda sertleştirilmiş,
Krom kaplı *Special steel, Cutters induction hardened,
Chrom plated*

KOD CODE	L mm	L inch	MODEL	g	□	TL/Ad.
3700 16 4140	140	5 1/2"	ROD - TUV GS	190	5	56,96
3700 16 4160	160	6 1/4"	ROD - TUV GS	245	5	68,41

3700

Yan Keski Ergonomik
Side Cutting Pliers

TS 60 • DIN ISO 5749



Özel alaşımli çelik, Kesici ağızlar indüksiyonda sertleştirilmiş,
Krom kaplı *Special steel, Cutters induction hardened,
Chrom plated*

KOD CODE	L mm	L inch	MODEL	g	□	TL/Ad.
3700 16 5140	140	5 1/2"	ERGONOMİK	165	5	62,66
3700 16 5160	160	6 1/4"	ERGONOMİK	215	5	75,24
3700 16 5180	180	7 1/8"	ERGONOMİK	215	5	87,75



3700

Süper İzole Yan Keski
Side Cutting Pliers, Super Insulated

TS 60 • TS 11068 • DIN 5744



⚡ 1000 V
E DIN EN 60900:2005



Özel alaşımli çelik, Kesici ağızlar indüksiyonda sertleştirilmiş,
Krom kaplı, Kalın PVC izoleli
*Special steel, Cutters induction hardened,
Chrom plated, Triple PVC insulated*

KOD CODE	L mm	L inch	g	□	TL/Ad.
3700 16 0160	160	6 1/4"	275	5	92,04

3710

Tepe Keski
End Cutting Nippers

TS 60 • DIN ISO 5748



Özel alaşımli çelik, Kesici ağızlar indüksiyonda sertleştirilmiş,
Vernikli, PVC izoleli
*Special steel, Cutters induction hardened,
Lacquered, PVC insulated*

KOD CODE	L mm	L inch	g	□	TL/Ad.
3710 15 0180	180	7 1/8"	295	5	45,35

3720

Çift Ağızlı Kablo Kesici
Cable Cutter, Double Edges



Özel alaşımli çelik, Kesici ağızlar indüksiyonda sertleştirilmiş,
Krom kaplı, PVC izoleli
*Special steel, Cutters induction hardened,
Chrom plated, PVC insulated*

KOD CODE	L mm	L inch	g	□	TL/Ad.
3720 16 0220	220	8"	320	5	69,80

3730

Yan Keski Ağır Tip (çelik tel için)
Heavy Duty (for piano wire)

TS 60 • TS 11068 • DIN 5744



Özel alaşımli çelik, Kesici ağızlar induksiyonda sertleştirilmiş,
Krom kaplı, PVC izoleli
*Special steel, Cutters induction hardened,
Chrom plated, PVC insulated*

KOD CODE	L mm	L inch	g	TL/Ad.
3730 16 2160	160	6 1/4"	200	5 76,11
3730 16 2200	200	8"	320	5 -----

3750

Kablo Sıyırma Pensi
Wire Strippers



Özel alaşımli çelik, Krom kaplı, Selüloz asetat saplı
Special steel, Chrom plated, Cellulose acetate handle

KOD CODE	L mm	L inch	g	TL/Ad.
3750 12 1160	160	6 1/4"	160	5 76,45

3750

Süper İzole Kablo Sıyırma Pensi
Wire Strippers Super Insulated



Özel alaşımli çelik, Krom kaplı, Kalın PVC izoleli
Special steel, Chrom plated, Triple PVC insulated

KOD CODE	L mm	L inch	g	TL/Ad.
3750 12 0160	160	6 1/4"	220	5 88,07

3650

Konnektör Sıkma Pensi
Connector Pliers



Özel alaşımli çelik, Krom kaplı, PVC izoleli
Special steel, Chrom plated, PVC insulated

KOD CODE	L mm	L inch	g	TL/Ad.
3650 12 0135	135	5 5/16"	235	5 -----

3800

Kerpeten
Carpenter Pincers

TS 60 • DIN ISO 9243



Özel alaşımli çelik, Kesici ağızlar induksiyonda sertleştirilmiş,
Vernikli, PVC izoleli
*Special steel, Cutters induction hardened,
Lacquered, PVC insulated*

KOD CODE	L mm	L inch	g	TL/Ad.
3800 15 0130	130	5 1/8"	140	5 -----
3800 15 0160	160	6 1/4"	220	5 40,06
3800 15 0180	180	7 1/8"	295	5 41,46
3800 15 0200	200	8"	330	5 50,44
3800 15 0250	250	10"	530	5 57,96

3830

Betoncu Kerpeteni
Tower Pincers

TS 60 • DIN ISO 9242



Özel alaşımli çelik, Kesici ağızlar induksiyonda sertleştirilmiş,
Vernikli, PVC izoleli
*Special steel, Cutters induction hardened,
Lacquered, PVC insulated*

KOD CODE	L mm	L inch	g	TL/Ad.
3830 15 0200	200	8"	290	5 -----
3830 15 0225	225	9"	345	5 49,71
3830 15 0250	250	10"	395	5 54,90
3830 15 0280	280	11"	450	5 61,47

3831

Betoncu Kerpeteni Yaylı
Tower Pincers with spring

TS 60 • DIN ISO 9242



Özel alaşımli çelik, Kesici ağızlar indüksiyonda sertleştirilmiş, Vernikli, PVC izoleli
Special steel, Cutters induction hardened, Lacquered, PVC insulated

KOD CODE	L mm	L inch	g		TL/Ad.
3831 15 0280	280	11"	455	5	67,36

3850

Danallya
Shoemakers Pliers



Özel alaşımli çelik, İndüksiyonda sertleştirilmiş, Siyah Oksit kaplı
Special steel, Induction hardened, Black finish

KOD CODE	L mm	L inch	g		TL/Ad.
3850 12 0200	200	8"	360	5	86,87

3852

Delik Zımba
Revolving Punch Plier



KOD CODE	L mm	L inch	g		TL/Ad.
3852 24 0225	225	9"	270	5	46,72

3860

Testere Çaprazı
Saw - Set Plier



Özel alaşımli çelik, İndüksiyonda sertleştirilmiş, Siyah oksit kaplı, PVC izoleli
Special steel, induction hardened, Black finish, PVC insulated

KOD CODE	L mm	L inch	g		TL/Ad.
3860 26 0180	180	7 1/8"	245	5	67,66

3550

Elektronikçi Yan Keski
Electronic Diagonal Side Cutting Pliers



Özel alaşımli çelik
Special steel

KOD CODE	L mm	g		TL/Ad.
3550 14 0125	125	76	5	49,39

3551

Elektronikçi Tepe Keski
Electronic End Cutting Pliers



Özel alaşımli çelik
Special steel

KOD CODE	L mm	g		TL/Ad.
3551 14 0125	125	77	5	49,39

3552

Elektronikçi Yuvarlak Uçlu Kargaburun
Electronic Round Nose Pliers



Özel alaşımli çelik
Special steel

KOD CODE	L mm	g		TL/Ad.
3552 14 0125	125	78	5	49,39

3553

Elektronikçi Düz Uçlu Kargaburun Electronic Flat Nose Pliers



Özel alışımlı çelik
Special steel

KOD CODE	L mm	g	TL/Ad.
3553 14 0150	150	88	5 49,39

3557

Elektronikçi Pense Electronic Pliers



Özel alışımlı çelik
Special steel

KOD CODE	L mm	g	TL/Ad.
3557 14 0125	125	80	5 49,39

3554

Elektronikçi Uzun Kargaburun Electronic Long Nose Pliers



Özel alışımlı çelik
Special steel

KOD CODE	L mm	g	TL/Ad.
3554 14 0150	150	88	5 49,39

3560 00 2104

Elektronikçi Keski ve Pense Seti (4 Parça) Electronic Cutting & Pliers Set (4 Pcs)



KOD CODE	L mm	İÇERİK CONTENTS	TL Ad.
3550 14 0125	125	Elektronikçi Yan Keski Electronic Diagonal Side Cutting Pliers	1
3551 14 0125	125	Elektronikçi Tepe Keski Electronic End Cutting Pliers	1
3554 14 0150	150	Elektronikçi Uzun kargaburun Electronic Long Nose Pliers	1 197.56
3557 14 0125	125	Elektronikçi Pense Electronic Pliers	1

3555

Elektronikçi Sivri Uçlu Düz Kargaburun Electronic Needle Flat Nose Pliers



Özel alışımlı çelik
Special steel

KOD CODE	L mm	g	TL/Ad.
3555 14 0150	150	86	5 49,39

3565 00 2104

Elektronikçi Kargaburun Seti 4 Parça Electronic Long Nose Pliers Set (4 Pcs)



KOD CODE	L mm	İÇERİK CONTENTS	TL Ad.
3552 14 0125	125	Elektronikçi Yuvarlak Uçlu Kargaburun Electronic Round Nose Pliers	1
3553 14 0150	150	Elektronikçi Düz Uçlu Kargaburun Electronic Flat Nose Pliers	1
3555 14 0150	150	Elektronikçi Sivri Uçlu Düz Kargaburun Electronic Needle Nose Pliers	1 197.56
3556 14 0150	150	Elektronikçi Sivri Uçlu Eğri Kargaburun Electronic Bent Needle Nose Pliers	1

3556

Elektronikçi Sivri Uçlu Eğri Kargaburun Electronic Needle Bent Nose Pliers



Özel alışımlı çelik
Special steel

KOD CODE	L mm	g	TL/Ad.
3556 14 0150	150	85	5 49,39

TSE

İŞ SAĞLIĞI VE GÜVENLİĞİ YÖNETİM SİSTEMİ BELGESİ OCCUPATIONAL HEALTH AND SAFETY MANAGEMENT SYSTEM CERTIFICATE



TÜRK STANDARDLARI ENSTİTÜSÜ
bu belge ile

İZELTAŞ İZMİR EL ALETLERİ SAN. VE TİC. A.Ş.
KEMALPAŞA CAD. NO:303 İŞIKKENT - BORNÖVA
İZMİR / TÜRKİYE

TURKISH STANDARDS INSTITUTION
hereby certifies that the organization

İZELTAŞ İZMİR EL ALETLERİ SAN. VE TİC. A.Ş.
KEMALPAŞA CAD. NO:303 İŞIKKENT - BORNÖVA
İZMİR / TÜRKİYE

TSE
İSG-OHSAS
TS 18001

Belge kapsamı Ek'te verilmiştir.

Scope of the certificate is given in annex

Belge No / Certificate No	OY-555/09
Belge Tarihi / Date of Certificate	09.11.2015
Geyerlilik Tarihi / Valid Until	09.11.2018
Revizyon Tarihi / Date of Revision	09.11.2015
İlk Belge Tarihi / Initial Certification Date	09.11.2009

Bu belge belgeleştirilme şartlarına
uygunluk sağlanıldığı yönünde geçerlidir.

Bu belge, Türk Standartları Enstitüsü'nün kuruluşu hakkındaki 132 sayılı kanun uyarınca verilmiştir.
This certificate is issued in accordance with the Law No. 132 establishing Turkish Standards Institution.

Almet NAMI

Izmir Belgeleştirme Müdürü
Izmir Certification Director

TÜRK STANDARDLARI ENSTİTÜSÜ
TURKISH STANDARDS INSTITUTION

351311201511081871

Tornavida ve Allen Anahtarlar

Screwdrivers and Hex Key Wrenches

4

*Tornavidalar
Kontrol Kalemleri
Bits Uçlar ve Aparatları
Allen Anahtarlar*

*Screwdrivers
Testers
Bits
Hex Key Wrenches*



4100
Kraft Seri Düz Uçlu Tornavida
Screwdriver, Kraft, Flat

TS 59 • DIN 5264 • DIN 5265

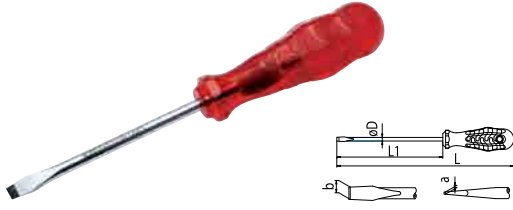
Krom vanadyum, Krom kaplı, Ucu siyah oksit, Selüloz asetat saplı
Chrom vanadium, Chrom plated and black tips, Cellulose acetate handle.

KOD CODE	øDxL1 mm	⊖		L mm	g	TL/Ad.
		a mm	b mm			
4100 17 0340	3x40	0.5	3	110	20	7,16
4100 17 0380	3x80	0.5	3	155	35	8,61
4100 17 0480	4x80	0.8	4	165	50	8,94
4100 17 4100	4x100	0.8	4	185	50	10,76
4100 17 0580	5x80	1.0	5.5	175	70	10,07
4100 17 5100	5x100	1.0	5.5	195	75	13,06
4100 17 5125	5x125	1.0	5.5	220	80	15,11
4100 17 5150	5x150	1.0	5.5	245	80	16,45
4100 17 6100	6x100	1.2	6.5	195	85	13,54
4100 17 6125	6x125	1.2	6.5	220	90	15,51
4100 17 6150	6x150	1.2	6.5	245	95	16,95
4100 17 6175	6x175	1.2	6.5	270	100	22,18
4100 17 7125	7x125	1.2	8	230	120	17,31
4100 17 7150	7x150	1.2	8	255	130	19,94
4100 17 7175	7x175	1.2	8	280	135	23,19
4100 17 8150	8x150	1.6	10	255	145	23,02
4100 17 8175	8x175	1.6	10	280	150	24,19
4100 17 8200	8x200	1.6	10	305	160	30,04
4100 17 9200	9x200	2.0	12	305	190	32,05
4100 17 1125	11x250	2.5	14	365	305	40,05

4100
Kraft Seri Düz Uçlu Tornavida Seti (8 Parça)
Screwdriver, Flat, Kraft Set (8 Pcs)

KOD CODE	İÇERİK CONTENTS	g	TL/Ad.
4100 00 8108	3x80 - 4x80 - 4x100 5x100 - 5x125 - 6x100 6x125 - 6x150 ⊖ Düz uçlu/Flat	550	8 102,48

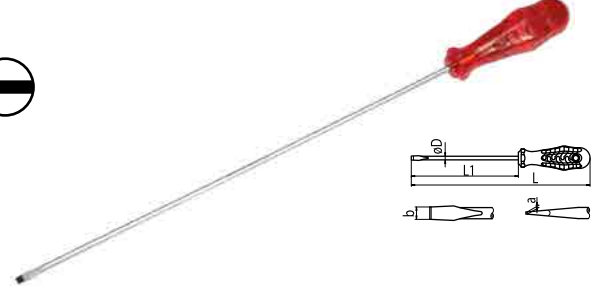
4100
Kraft Seri Süngüsü Uzun Düz Uçlu Tornavida
Screwdriver, Kraft, Flat, Long

Krom vanadyum, Krom kaplı, Ucu siyah oksit, Selüloz asetat saplı
Chrom vanadium, Chrom plated and black tips, Cellulose acetate handle.

KOD CODE	øDxL1 mm	⊖		L mm	g	TL/Ad.
		a mm	b mm			
4100 17 3150	3x150	0.5	3	225	35	14,49
4100 17 3250	3x250	0.5	3	325	40	17,02
4100 17 4250	4x250	0.8	4	335	65	27,36
4100 17 4300	4x300	0.8	4	385	70	28,39
4100 17 5200	5x200	1.0	5.5	295	90	30,04
4100 17 5250	5x250	1.0	5.5	345	95	31,66
4100 17 5300	5x300	1.0	5.5	395	105	32,71
4100 17 5350	5x350	1.0	5.5	445	115	35,79
4100 17 6350	6x350	1.2	6.5	445	125	37,90
4100 17 6400	6x400	1.2	6.5	495	145	39,08
4100 17 6450	6x450	1.2	6.5	545	160	41,37
4100 17 1130	11x300	2.5	14	415	345	42,14

4100
Kraft Seri Tornavida Seti (7 parça)
Screwdriver, Kraft Set (7 Pcs)

KOD CODE	İÇERİK CONTENTS	g	TL/Ad.
4100 00 8107	3x80 - 4x80 - 4x100 ⊖ 5x125 - 6x150 Düz uçlu/Flat ⊕ 4.5x80 - 6x100 Yıldız uçlu/Phillips	445	7 90,75

4120

Kraft Seri Yıldız Uçlu Tornavida Screwdriver, Kraft, Phillips

TS 59 • DIN ISO 8764

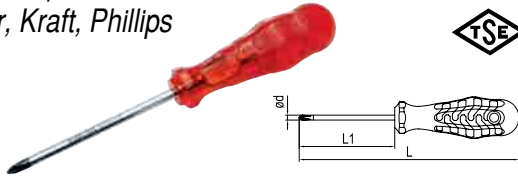

Krom vanadyum, Krom kaplı, Ucu siyah oksit, Selüloz asetat saplı
Chrom vanadium, Chrom plated and black tips,
Cellulose acetate handle.

KOD CODE	ødxL1 mm	+	L mm	g	□	TL/Ad.
4120 18 0360	3x60	Ph0	135	30	10	9,54
4120 18 4580	4.5x80	Ph1	165	55	10	13,76
4120 18 5100	4.5x100	Ph1	185	55	10	15,32
4120 18 5150	4.5x150	Ph1	235	60	10	18,37
4120 18 6100	6x100	Ph2	195	85	10	16,62
4120 18 6150	6x150	Ph2	245	95	10	19,95
4120 18 6200	6x200	Ph2	295	105	10	25,93
4120 18 8150	8x150	Ph3	255	150	10	31,66
4120 18 1200	10x200	Ph4	315	240	10	49,09

4120

Kraft Seri Süngüsü Uzun Yıldız Uçlu Tornavida Screwdriver, Kraft, Phillips, Long

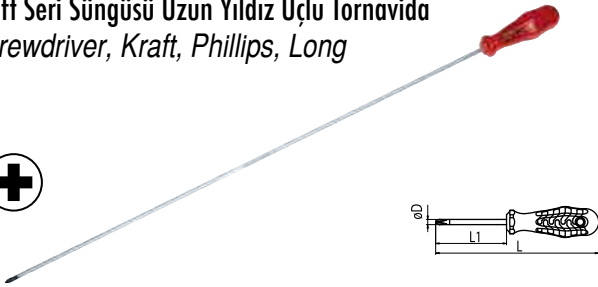

Krom vanadyum, Krom kaplı, Ucu siyah oksit, Selüloz asetat saplı
Chrom vanadium, Chrom plated and black tips,
Cellulose acetate handle.

KOD CODE	øDxL1 mm	+	L mm	g	□	TL/Ad.
4120 18 5300	4.5x300	Ph1	385	80	10	43,73
4120 18 5500	4.5x500	Ph1	585	105	10	46,37
4120 18 6300	6x300	Ph2	395	125	10	45,25
4120 18 6500	6x500	Ph2	595	165	10	48,04



4120

Kraft Seri Yıldız Uçlu Tornavida Seti (6 parça) Screwdriver, Kraft, Phillips, Set (6 Pcs)



KOD CODE	İÇERİK CONTENTS	g	□	TL/Ad.
4120 00 8106	3x60 - 4.5x80 4.5x100 - 4.5x150 6x100 - 6x150 Yıldız uçlu/Phillips	380	6	93,56

4110

Kraft Seri Düz Uçlu Topaç Tornavida Screwdriver, Kraft, Stubby, Flat

TS 59 • DIN 5264 • DIN 5265

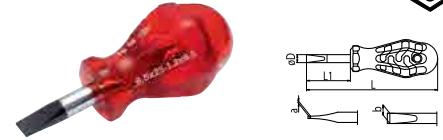

Krom vanadyum, Krom kaplı, Ucu siyah oksit, Selüloz asetat saplı
Chrom vanadium, Chrom plated and black tips,
Cellulose acetate handle.

KOD CODE	øDxL1 mm	-		L mm	g	□	TL/Ad.
		a mm	b mm				
4110 17 5525	5.5x25	1	5.5	70	30	5	9,34
4110 17 5540	5.5x40	1	5.5	105	45	5	12,69
4110 17 6525	6.5x25	1.2	6.5	70	35	5	10,42
4110 17 6540	6.5x40	1.2	6.5	105	50	5	14,42
4110 17 0825	8x25	1.2	8	70	40	5	11,48
4110 17 0840	8x40	1.2	8	105	60	5	15,90

4130

Kraft Seri Yıldız Uçlu Topaç Tornavida Screwdriver, Kraft, Stubby, Phillips

TS 59 • DIN ISO 8764

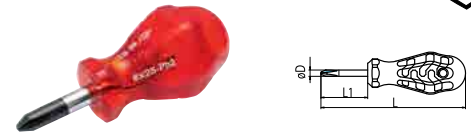

Krom vanadyum, Krom kaplı, Ucu siyah oksit, Selüloz asetat saplı
Chrom vanadium, Chrom plated and black tips,
Cellulose acetate handle.

KOD CODE	øDxL1 mm	+	L mm	g	□	TL/Ad.
4130 18 4525	4.5x25	Ph1	70	30	5	9,99
4130 18 4540	4.5x40	Ph1	105	40	5	13,18
4130 18 0625	6x25	Ph2	70	30	5	10,92
4130 18 0640	6x40	Ph2	105	50	5	14,93

Tornavida Sehpası
Display Frame For Screwdrivers



Sacdan imal edilmiş, Fırın boyalı
Made from metal sheet, Electrostatic paint

KOD CODE	ÖLÇÜ SIZE	İÇERİK CONTENTS	g	TL/Ad.
8003 00 6270	550x490x250	3x80 - 4x80 - 5x100 6x125 - 7x125 - 6x150 8x175 - 9x200 - 11x250 S.Asetat Saplı Düz Uçlu Tornavida (5 Adet) Screwdriver Flat (5 pcs) 3x60 - 4.5x80 - 6x100 8x150 - 10x200 S.Asetat Saplı Yıldız Uçlu Tornavida(5 Adet) Screwdriver Phillips (5 pcs)	14225 70	1593,54

Rod Seri Düz Uçlu Tornavida
Screwdriver, Rod, Flat

TS 59 • DIN 5264 • DIN 5265

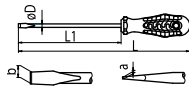

Krom vanadyum, Krom kaplı, Ucu siyah oksit, PP saplı
Chrome vanadium, Chrom plated and black tips, PP handle

KOD CODE	øDxL1 mm	-		L mm	g	TL/Ad.	
		a mm	b mm				
4300 17 0380	3x80	0.5	3	155	25	10	7,87
4300 17 0480	4x80	0.8	4	165	35	10	8,12
4300 17 4100	4x100	0.8	4	185	40	10	9,81
4300 17 5100	5x100	1.0	5.5	195	60	10	11,87
4300 17 5125	5x125	1.0	5.5	220	60	10	13,74
4300 17 6100	6x100	1.2	6.5	195	65	10	12,31
4300 17 6125	6x125	1.2	6.5	220	70	10	14,11
4300 17 6150	6x150	1.2	6.5	245	80	10	15,39
4300 17 7125	7x125	1.2	8	230	95	10	15,74
4300 17 7150	7x150	1.2	8	255	105	10	18,12
4300 17 8175	8x175	1.6	10	280	130	10	21,99
4300 17 9200	9x200	2.0	12	305	165	10	29,14
4300 17 1125	11x250	2.5	14	365	270	10	36,40

Rod Seri Yıldız Uçlu Tornavida
Screwdriver, Rod, Phillips

TS 59 • DIN ISO 8764

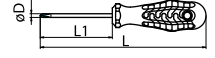

Krom vanadyum, Krom kaplı, Ucu siyah oksit, PP saplı
Chrome vanadium, Chrom plated and black tips, PP handle

KOD CODE	øDxL1 mm	+	L mm	g	TL/Ad.	
4320 18 0360	3x60	Ph0	135	25	10	8,70
4320 18 4580	4.5x80	Ph1	165	40	10	12,51
4320 18 6100	6x100	Ph2	195	70	10	15,13
4320 18 8150	8x150	Ph3	255	140	10	28,78

Rod Seri Tornavida Seti (7 Parça)
Screwdriver, Rod, Set (7 Pcs)



KOD CODE	İÇERİK CONTENTS	g	TL/Ad.
4300 00 8107	3x80 - 4x80 - 4x100 5x125 - 6x150 Düz uçlu/Flat 4.5x80 - 6x100 Yıldız uçlu/Phillips	520	7 82,57

Rod Seri Pozidriv Yıldız Uçlu Tornavida
Screwdriver, Rod, Pozidriv

TS 59 • DIN ISO 8764

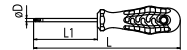

Krom vanadyum, Krom kaplı, Ucu siyah oksit, PP saplı
Chrome vanadium, Chrom plated and black tips, PP handle

KOD CODE	øDxL1 mm	+	L mm	g	TL/Ad.	
4325 18 0360	3x60	Pz0	135	25	10	9,54
4325 18 4580	4.5x80	Pz1	165	40	10	13,76
4325 18 6100	6x100	Pz2	195	70	10	16,62
4325 18 8150	8x150	Pz3	255	140	10	31,66
4325 18 1020	10x200	Pz4	315	280	10	-----

4350

Ergonomik Seri Düz Uçlu Tornavida
Screwdriver, Ergonomic, Flat

TS 59 • DIN 5264 • DIN 5265



Krom vanadyum, Krom kaplı, Ucu siyah oksit, İki komponent saplı
Chrome vanadium, Chrom plated and black tips,
Two component handle.

KOD CODE	ØDxL1 mm	⊖		L mm	g	□	TL/Ad.
		a mm	b mm				
4350 17 0380	3x80	0.5	3	155	25	10	8,61
4350 17 0480	4x80	0.8	4	165	40	10	8,94
4350 17 4100	4x100	0.8	4	185	40	10	10,76
4350 17 5100	5x100	1.0	5.5	195	60	10	13,06
4350 17 5125	5x125	1.0	5.5	220	65	10	15,11
4350 17 6100	6x100	1.2	6.5	195	70	10	13,54
4350 17 6125	6x125	1.2	6.5	220	75	10	15,51
4350 17 6150	6x150	1.2	6.5	245	80	10	16,95
4350 17 7125	7x125	1.2	8	230	100	10	17,31
4350 17 7150	7x150	1.2	8	255	110	10	19,94
4350 17 8175	8x175	1.6	10	280	140	10	24,19
4350 17 9200	9x200	2	12	305	180	10	32,05
4350 17 1125	11x250	2.5	14	365	280	10	40,05

4370

Ergonomik Seri Yıldız Uçlu Tornavida
Screwdriver, Ergonomic, Phillips

TS 59 • DIN ISO 8764



Krom vanadyum, Krom kaplı, Ucu siyah oksit, İki komponent saplı
Chrome vanadium, Chrom plated and black tips,
Two component handle.

KOD CODE	ØDxL1 mm	+	L mm	g	□	TL/Ad.
4370 18 4580	4.5x80	Ph1	165	45	10	13,76
4370 18 6100	6x100	Ph2	195	70	10	16,62
4370 18 8150	8x150	Ph3	255	130	10	31,66

4350

Ergonomik Seri Tornavida Seti (7 Parça)
Screwdriver, Ergonomic Set (7 Pcs.)



KOD CODE	İÇERİK CONTENTS	g	□	TL/Ad.
4350 00 8107	3x80 - 4x80 - 4x100	370	7	90,75
	5x125 - 6x150			
	Düz uçlu/Flat			
	4.5x80 - 6x100			
	Yıldız uçlu/Phillips			

4550

Elektrik Kontrol Kalemi
Voltage Tester

TS 13108

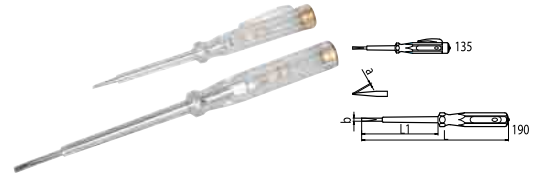

Krom vanadyum, Krom kaplı, Şeffaf selüloz asetat saplı
Chrome vanadium, Chrom plated, Transparent cellulose acetate handle

KOD CODE	L mm	⊖		L1 mm	g	□	TL/Ad.
		a mm	b mm				
4550 17 0135	135	0.5	3	60	20	10	10,54
4550 17 0190	190	0.8	4	100	40	10	13,29

4555

Master Kontrol Kalemi
Voltage Tester Master

TS 13108



Krom vanadyum, Krom kaplı, Şeffaf selüloz asetat saplı
Chrome vanadium, Chrom plated, Transparent cellulose acetate handle

KOD CODE	L mm	⊖		L1 mm	g	□	TL/Ad.
		a mm	b mm				
4555 17 0165	165	0.5	3.5	88	40	10	14,61

4551

Tester Kontrol Kalemi
A/C Tester

TS 13108



Krom vanadyum, Krom kaplı, Şeffaf selüloz asetat saplı
Chrom vanadium, Chrom plated, Transparent cellulose acetate handle

KOD CODE	L mm	⊖		L1 mm	g	□	TL/Ad.
		a mm	b mm				
4551 17 0190	190	0.8	4	100	40	10	25,94

4101

Süngüsü İzoleli Düz Uçlu Tornovida
Screwdriver, Electrician Blade,
Insulated, Flat

TS 59 • DIN 7437 • TS 11489



Krom vanadyum, Siyah oksit kaplı, PP izoleli
Chrom vanadium, Black finish, PP handle

KOD CODE	øDxL1 mm	⊖		L mm	g	□	TL/Ad.
		a mm	b mm				
4101 17 2575	2.5x75	0.4	2.5	150	25	10	10,69
4101 17 4100	4x100	0.8	4	185	40	10	13,54
4101 17 5512	5.5x125	1	5.5	220	70	10	18,73
4101 17 6515	6.5x150	1.2	6.5	245	90	10	20,37

4121

Süngüsü İzoleli Yıldız Uçlu Tornovida
Screwdriver, Electrician Blade,
Insulated, Phillips

TS 59 • DIN ISO 8764



Krom vanadyum, Siyah oksit kaplı, PP izoleli
Chrom vanadium, Black finish, PP handle

KOD CODE	øDxL1 mm	+	L mm	g	□	TL/Ad.
4121 18 0360	3x60	Ph0	135	25	10	12,68
4121 18 4580	4.5x80	Ph1	165	45	10	16,95
4121 18 6100	6x100	Ph2	195	70	10	20,66

4101

Süngüsü İzoleli Tornovida Seti (6 parça)
Screwdriver, Electrician Blade, Insulated Set (6 pcs)



KOD CODE	İÇERİK CONTENTS	g	□	TL/Ad.
4101 00 9106	2.5x75 - 4x100	335	6	100,94
	5.5x125 - 6.5x150			
	Düz uçlu/Flat			
	4.5x80 - 6x100			
	Yıldız uçlu/Phillips			

4240

Değişken Uçlu Tornovida
Screwdriver - Reversible

TSEK



Krom vanadyum, Krom kaplı
Chrom vanadium, Chrom plated

KOD CODE	øDxL1 mm	⊖	+	L mm	g	□	TL/Ad.
4240 17 0680	6x80	1.2x6	Ph2	175	80	10	15,29

4240

Değişken Uçlu Tornovida Takımı
Screwdriver Set - Reversible

TSEK



Krom vanadyum, Krom kaplı
Chrom vanadium, Chrom plated

KOD CODE	İÇERİK CONTENTS	g	□	TL/Ad.
4240 00 7102	4.5x80 - 6x80	105	1	28,00

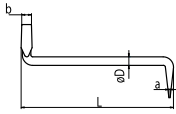
4890
Z Tipi Tornavida
Offset Screwdriver

Krom vanadyum, Krom kaplı
Chrom vanadium, Chrom plated

KOD CODE	ØDxL mm	⊖		g	□	TL/Ad.
		a mm	b mm			
4890 17 7125	7x125	1.2	8	50	10	8,71

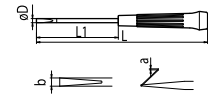
4500
Elektronikçi Tip (Klemens) Düz Uçlu Tornavida
Electronic Screwdriver, Flat

Krom vanadyum, Krom kaplı, Ucu siyah oksit, PP saplı
Chrome vanadium, Chrom plated and black tips, PP handle

KOD CODE	ØDxL1 mm	⊖		L mm	g	□	TL/Ad.
		a mm	b mm				
4500 17 2560	2.5x60	0.4	2.5	140	15	10	6,91
4500 17 2580	2.5x80	0.4	2.5	160	15	10	7,70
4500 17 0380	3x80	0.5	3	160	15	10	8,17
4500 17 3100	3x100	0.5	3	180	20	10	9,99
4500 17 3125	3x125	0.5	3	205	20	10	13,18
4500 17 3510	3.5x100	0.6	3.5	180	20	10	10,31
4500 17 0480	4x80	0.8	4	160	20	10	8,38
4500 17 4100	4x100	0.8	4	180	20	10	10,31
4500 17 4125	4x125	0.8	4	205	25	10	13,89
4500 17 4150	4x150	0.8	4	230	25	10	15,11

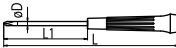
4520
Elektronikçi Tip (Klemens) Yıldız Uçlu Tornavida
Electronic Screwdriver, Phillips

Krom vanadyum, Krom kaplı, Ucu siyah oksit, PP saplı
Chrome vanadium, Chrom plated and black tips, PP handle

KOD CODE	ØDxL1 mm	+	L mm	g	□	TL/Ad.
4520 18 0360	3x60	Ph0	140	15	10	8,62
4520 18 3100	3x100	Ph0	180	20	10	-----
4520 18 0480	4x80	Ph0	160	20	10	12,42
4520 18 4100	4x100	Ph0	180	20	10	-----
4520 18 4150	4x150	Ph0	230	25	10	16,62

4500
Elektronikçi Tip (Klemens) Tornavida Seti (6 Parça)
Electronic Screwdriver Set (6 Pcs)

KOD CODE	İÇERİK CONTENTS	g	□	TL/Ad.	
4500 00 8106	⊖	3x80 - 3x100	115	6	67,49
	⊖	3x125 - 4x150			
	⊖	Düz uçlu/Flat			
	+	3x60 - 4x80			
		Yıldız uçlu/Phillips			

4770
Lokma Uçlu Tornavida (mm)
Nut Spinner (mm)

TS 3793 • DIN 3125

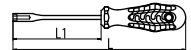

Krom vanadyum, Krom kaplı, PP Saplı
Chrom vanadium, Chrom plated, PP insulated

KOD CODE	⊖ mm	L mm	L1 mm	g	□	TL/Ad.
4770 19 0030	3	210	125	80	10	-----
4770 19 0035	3.5	210	125	80	10	-----
4770 19 0040	4	220	125	80	10	26,29
4770 19 0045	4.5	220	125	80	10	-----
4770 19 0050	5	220	125	80	10	26,29
4770 19 0055	5.5	220	125	80	10	26,29
4770 19 0060	6	220	125	80	10	26,29
4770 19 0070	7	230	125	100	10	28,23
4770 19 0080	8	230	125	110	10	28,23
4770 19 0090	9	230	125	115	10	30,49
4770 19 0100	10	230	125	115	10	30,49
4770 19 0110	11	230	125	130	10	33,30
4770 19 0120	12	230	125	135	10	35,73
4770 19 0130	13	230	125	140	10	38,50
4770 19 0140	14	230	125	140	10	42,59

4770

Lokma Uçlu Tornavida Seti (8 Parça, mm)
Nut Spinner Set (8 Pcs, mm)



KOD CODE	İÇERİK CONTENTS	g	TL/Ad.
4770 00 8108	6 - 7 - 8 - 9 - 10 11 - 12 - 13	2145	8 251,26

4772

Süngüsü İzoleli Lokma Uçlu Tornavida
Nut Spinner, Electrician Blade Insulated

TS 3793-DIN 3125
DIN EN 60900

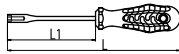

Krom vanadyum, PP saplı
Chrome vanadium, PP handle

KOD CODE	mm	L mm	L1 mm	g	TL/Ad.
4772 19 0040	4	220	125	90	10 35,49
4772 19 0050	5	220	125	90	10 35,49
4772 19 0055	5.5	220	125	90	10 35,49
4772 19 0060	6	220	125	90	10 35,49
4772 19 0070	7	230	125	110	10 38,12
4772 19 0080	8	230	125	120	10 38,12
4772 19 0090	9	230	125	125	10 41,14
4772 19 0100	10	230	125	125	10 41,14
4772 19 0110	11	230	125	140	10 44,96
4772 19 0120	12	230	125	145	10 48,25
4772 19 0130	13	230	125	150	10 51,98
4772 19 0140	14	230	125	150	10 57,50

4772

Süngüsü İzoleli Lokma Uçlu Tornavida Seti (8 Parça)
Nut Spinner, Electrician Blade Insulated Set (8 Pcs)



KOD CODE	İÇERİK CONTENTS	g	TL/Ad.
4772008108	6 - 7 - 8 - 9 - 10 - 11 - 12 - 13	2225	8 339,20

4775

Torx® Uçlu Tornavida
Torx® Driver

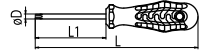

Krom vanadyum, Krom kaplı, Ucu siyah oksit, PP saplı
Chrome vanadium, Chrom plated and black tips, PP handle

KOD CODE	ØDxL1 mm	Star	L mm	g	TL/Ad.
4775 18 0010	4x80	T10	165	35	10 14,23
4775 18 0015	4x80	T15	165	35	10 14,23
4775 18 0020	4x100	T20	185	40	10 15,82
4775 18 0025	4.5x100	T25	185	40	10 18,29
4775 18 0027	5x125	T27	220	60	10 20,19
4775 18 0030	6x125	T30	220	70	10 21,44
4775 18 0040	7x125	T40	230	100	10 26,64
4775 18 0045	8x125	T45	230	120	10 30,14

4776

Delikli Torx® Uçlu Tornavida
Torx® Screwdriver / tamper Resistance

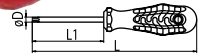

Krom vanadyum, Krom kaplı, Ucu siyah oksit, PP saplı
Chrome vanadium, Chrom plated and black tips, PP handle

KOD CODE	ØDxL1 mm	Star	L mm	g	TL/Ad.
4776 18 0009	4x60	TR9	145	35	10 17,18
4776 18 0010	4x80	TR10	165	35	10 17,77
4776 18 0015	4x80	TR15	165	40	10 17,77
4776 18 0020	4x100	TR20	185	40	10 19,79
4776 18 0025	4.5x100	TR25	185	45	10 22,86
4776 18 0027	5x125	TR27	220	60	10 25,26
4776 18 0030	6x125	TR30	220	70	10 26,84
4776 18 0040	7x125	TR40	230	100	10 33,29

4780

Manyetik Bits Tutucu Tornavida (Uzun)
Screwdriver, Magnetic Bit Holder (Long)

TS 8748
DIN 3126
DIN 3127



KOD CODE	mm	L mm	L1 mm	g		TL/Ad.
4780 19 6120	6.3	230	120	105	10	30,84

4782

Süngüsü İzoleli Manyetik Bits Tutucu Tornavida
Screwdriver, Magnetic Bit Holder Insulated

TS 8748
DIN 3126
DIN 3127
DIN EN 60900



KOD CODE	mm	L mm	L1 mm	g		TL/Ad.
4782 19 6120	6.3	230	120	115	10	41,65

4785

Manyetik Bits Tutucu Tornavida (Kısa)
Screwdriver, Magnetic Bit Holder, (Short)

TS 8748
DIN 3126
DIN 7427



KOD CODE	mm	L mm	L1 mm	g		TL/Ad.
4785 19 6330	6.3	130	30	60	10	17,37

4790

Üniversal Bits Adaptörü (Manyetik)
Screwdriver Universal Bit Holder
(Magnetic)

TS 8748 • DIN 3126 • DIN 7427



KOD CODE	mm	mm	L mm	g		TL/Ad.
4790 26 6360	6.3	6.3	60	25	10	12,22

4795

T Tipi Manyetik Bits Tutucu Tornavida
Magnetic Bit Holde With T-Handle

TS 8748
DIN 3126
DIN 7427



KOD CODE	mm	L mm	L1 mm	g		TL/Ad.
4795 19 0010	6.3	185	130	60	10	32,64

4788

Manyetik Bits Tutucu Tornavida, Flexible
Screwdriver, Magnetic Bit Holder, Flexible



KOD CODE	mm	L mm	L1 mm	g		TL/Ad.
4788 19 6160	6.3	275	170	130	10	53,39

4815

Değişken Bits Uçlu Tornavida Set (7 parça)
Screwdriver - Interchangeable Bits Set (7 pcs)



KOD CODE	İÇERİK CONTENTS	g		TL/Ad.
4815 00 6107	100mm Sap Ph1x4.5 Ph2x5.5 Ph3x7 Pz1x4.5 Pz2x5.5 Pz3x7	140	1	32,53

4800
6'li Bits Set
Bit Set (6 Pcs)

KOD CODE	İÇERİK CONTENTS	g	□	TL/Ad.
4800 00 8106	0.6x4.5 - 0.8x5.5	50	6	11,98
	Ph1 - Ph2 - Ph3			
	T27			

4800
7'li Bits Set
Bit Set (7 pcs)

KOD CODE	İÇERİK CONTENTS	g	□	TL/Ad.
4800 00 7107	0.6x4.5 - 0.8x5.5	90	7	33,90
	Ph1 - Ph2 - Ph3			
	T27			
	6.3 x 6.0 Adaptör			

4800
7'li Bits Set
Bit Set (7 pcs)

KOD CODE	İÇERİK CONTENTS	g	□	TL/Ad.
4800 00 7207	0.6x4.5 - 0.8x5.5	80	7	33,18
	Ph1 - Ph2 - Ph3			
	T27			
	6.3 x 6.0 Adaptör			

4800
8'li Bits Takım (Kısa)
Bit Set (Short 8 Pcs)

KOD CODE	İÇERİK CONTENTS	g	□	TL/Ad.
4800 00 8208	0.6x4.5 - 0.8x5.5	150	8	51,27
	Ph1 - Ph2 - Ph3			
	T27			
	6.3 x 60 Adaptör			
6.3 x 30 Bits tornavida				

4800
8'li Bits Takım (Uzun)
Bit Set (Long 8 Pcs)

KOD CODE	İÇERİK CONTENTS	g	□	TL/Ad.
4800 00 8108	0.6x4.5 - 0.8x5.5	155	8	46,51
	Ph1 - Ph2 - Ph3			
	T27 - T30			
	6.3 x 120 Bits tornavida			

4800
10'lu Bits Set
Bit Set (10 Pcs)

KOD CODE	İÇERİK CONTENTS	g	□	TL/Ad.
4800 00 8110	0.6x4.5 - 0.8x5.5	55	10	25,03
	1.2x6.5			
	Ph1 - Ph2 - Ph3			
	T25 - T27 - T30 - T40			

4800

31'li Bits Takım Kutulu
Bit Set In Metal Case (31 Pcs)



KOD CODE	İÇERİK CONTENTS	g		TL/Ad.
4800 00 6131	0.6x4.5 - 0.8x5.5	385	6 - 6	89,00
	1.2x6.5			
	Ph1			
	Ph2 - Ph3			
	T27			
	T25 - T30 - T40			
	6.3 x 60 Adaptör			

4810

Düz Bits
Flat Bit

TS 8748 • DIN 3127



Krom vanadyum
Chrom vanadium

KOD CODE		L mm	g		TL/Ad.
4810 20 0645	0.6x4.5	25	5	10	1,89
4810 20 0855	0.8x5.5	25	5	10	1,89
4810 20 1265	1.2x6.5	25	5	10	1,89
4810 20 5645	0.6x4.5	50	10	10	2,71
4810 20 5855	0.8x5.5	50	10	10	2,71
4810 20 5265	1.2x6.5	50	10	10	2,71

4810

Düz Bits Set (25 mm)
Flat Bit Set (25 mm)



KOD CODE		g		TL/Ad.
4810 00 0645	06x4.5	45	10	19,97
4810 00 0855	0.8x5.5	50	10	19,97
4810 00 1265	1.2x6.5	55	10	19,97

4820

Yıldız Bits
Phillips Bit

TS 8748 • DIN 3128



Krom vanadyum
Chrom vanadium

KOD CODE		L mm	g		TL/Ad.
4820 21 0001	Ph1	25	5	10	1,49
4820 21 0002	Ph2	25	5	10	1,49
4820 21 0003	Ph3	25	5	10	1,49
4820 21 0011	Ph1	50	10	10	2,15
4820 21 0012	Ph2	50	10	10	2,15
4820 21 0013	Ph3	50	10	10	2,15

4820

Yıldız Bits Set (25 mm)
Phillips Bit Set (25 mm)



KOD CODE		g		TL/Ad.
4820 00 0001	Ph1	50	10	15,85
4820 00 0002	Ph2	50	10	15,85
4820 00 0003	Ph3	55	10	15,85

4825

Pozidriv Bits
Pozidriv Bit

TS 8748 • DIN 3127



Krom vanadyum
Chrom vanadium

KOD CODE		L mm	g		TL/Ad.
4825 21 0001	Pz1	25	5	10	1,49
4825 21 0002	Pz2	25	5	10	1,49
4825 21 0003	Pz3	25	5	10	1,49
4825 21 0011	Pz1	50	10	10	2,93
4825 21 0012	Pz2	50	10	10	2,93
4825 21 0013	Pz3	50	10	10	2,93

4825

Pozidriv Bits Set (25 mm)
Pozidriv Bit Set (25 mm)



KOD CODE	+	g	□	TL/Ad.
4825 00 0001	Pz1	50	10	15,85
4825 00 0002	Pz2	55	10	15,85
4825 00 0003	Pz3	55	10	15,85

4830

Torx® Bits
Torx® Bit

TS 8748 • DIN 3127



Krom vanadyum
Chrom vanadium

KOD CODE	★	L mm	g	□	TL/Ad.
4830 21 0025	T25	25	5	10	3,72
4830 21 0027	T27	25	5	10	3,72
4830 21 0030	T30	25	5	10	3,72
4830 21 0040	T40	25	5	10	3,72
4830 21 0125	T25	50	10	10	4,68
4830 21 0127	T27	50	10	10	4,68
4830 21 0130	T30	50	10	10	4,68
4830 21 0140	T40	50	10	10	4,68

4830

Torx® Bits Set (25 mm)
Torx® Bit Set (25 mm)



KOD CODE	★	g	□	TL/Ad.
4830 00 0025	T25	50	10	37,99
4830 00 0027	T27	50	10	37,99
4830 00 0030	T30	55	10	37,99
4830 00 0040	T40	60	10	37,99

4900

Allen Anahtar Altı Köşe (mm)
Hex Key Wrench (mm)

TS ISO 2936

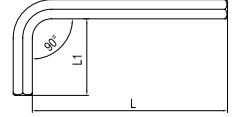

Krom vanadyum, Nikel kaplı
Chrom vanadium, Nickel Plated

KOD CODE	mm	L mm	L1 mm	g	□	TL/Ad.
4900 22 0015	1.5	45	14	1.5	10	1,29
4900 22 0020	2	50	16	2	10	1,55
4900 22 0025	2.5	56	18	4	10	1,89
4900 22 0030	3	63	20	6	10	2,13
4900 22 0035	3.5	66	22	8	10	2,63
4900 22 0040	4	70	25	10	10	2,71
4900 22 0050	5	80	28	20	10	2,81
4900 22 0060	6	90	32	30	10	3,71
4900 22 0070	7	95	34	40	10	5,51
4900 22 0080	8	100	36	55	10	5,79
4900 22 0090	9	105	38	75	10	7,16
4900 22 0100	10	112	40	100	10	8,86
4900 22 0120	12	125	45	160	10	11,28
4900 22 0140	14	140	56	250	5	19,44
4900 22 0160	16	152	60	375	5	31,54
4900 22 0170	17	160	63	425	5	34,23
4900 22 0190	19	180	70	610	5	44,81

4900

Allen Anahtar Takım Altı Köşe (mm)
Hex Key Wrench Set (mm)



KOD CODE	İÇERİK CONTENTS	g	□	TL/Ad.
4900 00 3110	2 - 2.5 - 3 - 4 - 5 - 6 7 - 8 - 9 - 10	400	10	42,12
4900 00 3112	2 - 2.5 - 3 - 3.5 - 4 - 5 6 - 7 - 8 - 9 - 10 - 12	565	12	56,03

4901

Allen Anahtar Altı Köşe (SAE)
Hex Key Wrench (SAE)

TSEK

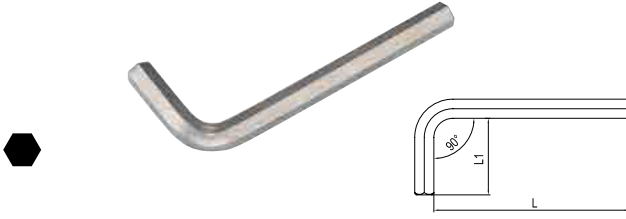

Krom vanadyum, Nikel kaplı
Chrom vanadium, Nickel Plated

KOD CODE	inch	L mm	L1 mm	g	TL/Ad.
4901 22 1984	5/64"	50	16	2	2,08
4901 22 2381	3/32"	54	18	4	2,27
4901 22 3125	1/8"	58	20	5	2,78
4901 22 3968	5/32"	62	22	10	3,37
4901 22 4762	3/16"	68	24	15	3,51
4901 22 5556	7/32"	74	26	25	4,70
4901 22 6350	1/4"	82	28	35	5,42
4901 22 7937	5/16"	94	32	55	7,16
4901 22 9825	3/8"	106	38	90	9,39
4901 22 1111	7/16"	118	42	130	12,62
4901 22 1270	1/2"	132	46	190	14,47
4901 22 1428	9/16"	144	52	265	21,14
4901 22 1587	5/8"	156	58	365	32,37
4901 22 1905	3/4"	176	66	600	44,06

4901

Allen Anahtar Takım Altı Köşe (SAE)
Hex Key Wrench Set (SAE)

TSEK

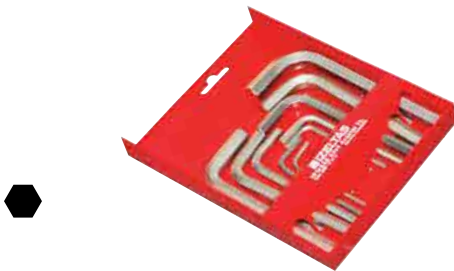

KOD CODE	İÇERİK CONTENTS	g	TL/Ad.
4901 00 3110	5/64" - 3/32" - 1/8" - 5/32" 3/16" - 7/32" - 1/4" - 5/16" 3/8" - 7/16"	405	10 53,30
4901 00 3112	5/64" - 3/32" - 1/8" - 5/32" 3/16" - 7/32" - 1/4" - 5/16" 3/8" - 7/16" - 1/2" - 9/16"	855	12 88,91

4903

Allen Anahtar Altı Köşe Uzun Boy (mm)
Hex Key Wrench Long Pattern (mm)

TS ISO 2936

TSE



Krom vanadyum, Nikel kaplı
Chrom vanadium, Nickel Plated

KOD CODE	mm	L mm	L1 mm	g	TL/Ad.
4903 22 0020	2	100	16	3	10 2,12
4903 22 0025	2.5	112	18	5	10 2,59
4903 22 0030	3	126	20	10	10 2,93
4903 22 0035	3.5	136.5	22	15	10 3,63
4903 22 0040	4	140	25	20	10 3,71
4903 22 0050	5	160	28	30	10 3,86
4903 22 0060	6	180	32	50	10 5,09
4903 22 0070	7	190	34	80	10 7,58
4903 22 0080	8	200	36	100	10 7,93
4903 22 0090	9	210	38	145	10 9,85
4903 22 0100	10	224	40	180	10 12,19
4903 22 0120	12	250	45	285	10 15,50
4903 22 0140	14	280	56	460	5 26,73
4903 22 0160	16	300	60	625	5 43,36
4903 22 0170	17	320	63	750	5 47,23
4903 22 0190	19	360	70	1100	5 61,62

4903

Allen Anahtar Takım Altı Köşe Uzun Boy (mm)
Hex Key Wrench Set Long Pattern (mm)

TSE



KOD CODE	İÇERİK CONTENTS	g	TL/Ad.
4903 00 3110	2 - 2.5 - 3 - 4 - 5 - 6 7 - 8 - 9 - 10	660	10 57,85
4903 00 3112	2 - 2.5 - 3 - 3.5 - 4 - 5 6 - 7 - 8 - 9 - 10 - 12	940	12 76,98



4905

Yuvarlak Başlı Allen Anahtar (mm) Hex Key Wrench Ballpoint (mm)

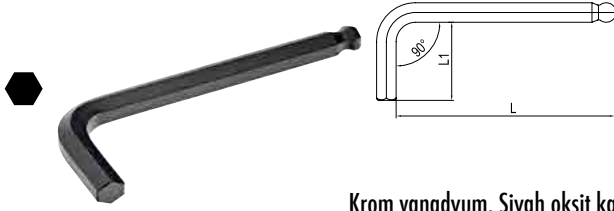

Krom vanadyum, Siyah oksit kaplı
Chrom vanadium, Black finish

KOD CODE	mm	L mm	L1 mm	g		TL/ Ad.
4905 22 0020	2	50	16	3	10	2,04
4905 22 0025	2.5	56	18	4	10	2,44
4905 22 0030	3	63	20	5	10	2,78
4905 22 0040	4	70	25	10	10	3,50
4905 22 0050	5	80	28	20	10	3,67
4905 22 0060	6	90	32	30	10	4,84
4905 22 0080	8	100	36	55	10	7,54
4905 22 0100	10	112	40	100	10	11,57

4905

Yuvarlak Başlı Allen Anahtar Takımı (8 Parça, mm) Hex Key Wrench Ballpoint Set (8 Pcs, mm)



KOD CODE	İÇERİK CONTENTS	g		TL/Ad.
4905 00 7108	2 - 2.5 - 3 - 4 5 - 6 - 8 - 10	275	8	38,38

4906

Yuvarlak Başlı Allen Anahtar Uzun Boy (mm) Hex Key Wrench Ballpoint Long Pattern (mm)

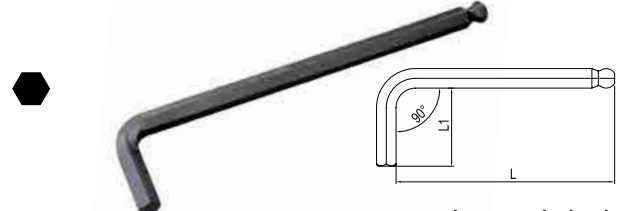

Krom vanadyum, Siyah oksit kaplı
Chrom vanadium, Black finish

KOD CODE	mm	L mm	L1 mm	g		TL/ Ad.
4906 22 0015	1.5	79	12	1.5	10	2,39
4906 22 0020	2	84	16	3	10	3,17
4906 22 0025	2.5	89	16	5	10	3,43
4906 22 0030	3	99	18	7	10	3,75
4906 22 0040	4	109	23	13	10	4,28
4906 22 0050	5	125	26	25	10	5,39
4906 22 0060	6	150	28	42	10	6,20
4906 22 0080	8	167	33	85	10	9,24
4906 22 0100	10	190	37	150	10	12,30

4906

Yuvarlak Başlı Allen Anahtar Takım Altı Köşe Uzun Boy (mm) Hex Key Wrench Ballpoint Long Pattern Set (mm)



KOD CODE	İÇERİK CONTENTS	g		TL/Ad.
4906 00 3109	1.5 - 2 - 2.5 - 3 - 4 - 5 - 6 8 - 10	355	9	50,15



4909

T Tipi Torx Allen Anahtar T Handle Torx Key Wrench

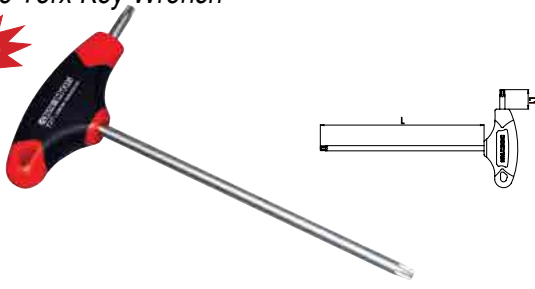

Krom vanadyum, Krom kaplı, PP saplı
Chrom vanadium, Chrom plated, PP handle

KOD CODE	★	L1 mm	L2 mm	g	□	TL/Ad.
4909 22 0009	T9	125	15	22	5	23,42
4909 22 0010	T10	125	15	22	5	23,90
4909 22 0015	T15	125	15	26	5	24,35
4909 22 0020	T20	125	15	44	5	24,59
4909 22 0025	T25	150	20	49	5	25,18
4909 22 0027	T27	150	20	62	5	25,77
4909 22 0030	T30	150	20	82	5	26,50
4909 22 0040	T40	175	25	100	5	27,51

4909

T Tipi Torx Allen Anahtar Takımı (8 Parça) T Handle Torx Keywrench Set (8 Pcs)



Krom vanadyum, Krom kaplı
Chrom vanadium, Chrom finish

KOD CODE	İÇERİK CONTENTS	g	□	TL/Ad.
4909 00 8108	T9-T10-T15-T20-T25-T27 T30-T40	407	8	201,22

4910

Torx® Allen Anahtar Torx® Key Wrench

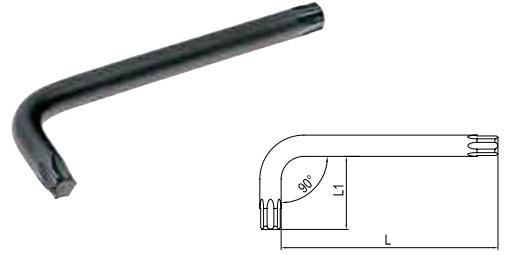

Krom vanadyum, Siyah oksit kaplı
Chrom vanadium, Black finish

KOD CODE	★	L mm	L1 mm	g	□	TL/Ad.
4910 22 0006	T6	42	16	2	10	9,28
4910 22 0007	T7	48	16	2	10	9,28
4910 22 0008	T8	48	16	3	10	9,28
4910 22 0009	T9	48	16	3	10	9,36
4910 22 0010	T10	51	17	4	10	9,36
4910 22 0015	T15	54	18	5	10	9,65
4910 22 0020	T20	57	19	5	10	10,12
4910 22 0025	T25	60	20	10	10	10,12
4910 22 0027	T27	64	21	15	10	10,12
4910 22 0030	T30	70	24	20	10	10,86
4910 22 0040	T40	76	26	30	10	11,52
4910 22 0045	T45	83	29	40	10	14,22
4910 22 0050	T50	95	32	60	10	16,21
4910 22 0055	T55	108	35	125	10	22,52
4910 22 0060	T60	120	38	185	10	31,08

4910

Torx® Allen Anahtar Takımı (8 Parça) Torx® Key Wrench Set (8 Pcs)



KOD CODE	İÇERİK CONTENTS	g	□	TL/Ad.
4910 00 7108	T9 - T10 - T15 T20 - T25 - T27 T30 - T40	155	8	81,11

4912

Kaset Allen Anahtar Takımı (7 Parça, mm)
Hex Key Wrench Folding Set (7 Pcs, mm)



Krom vanadyum, Nikel kaplı
Chrom vanadium, Nickel finish

KOD CODE	İÇERİK CONTENTS	g	TL/Ad.
4912 00 3107	2.5 - 3 - 4 - 5 - 6 - 8 - 10	355	1 38,73
4912 00 0007	1.5 - 2 - 2.5 - 3 - 4 - 5 - 6	130	1 33,97

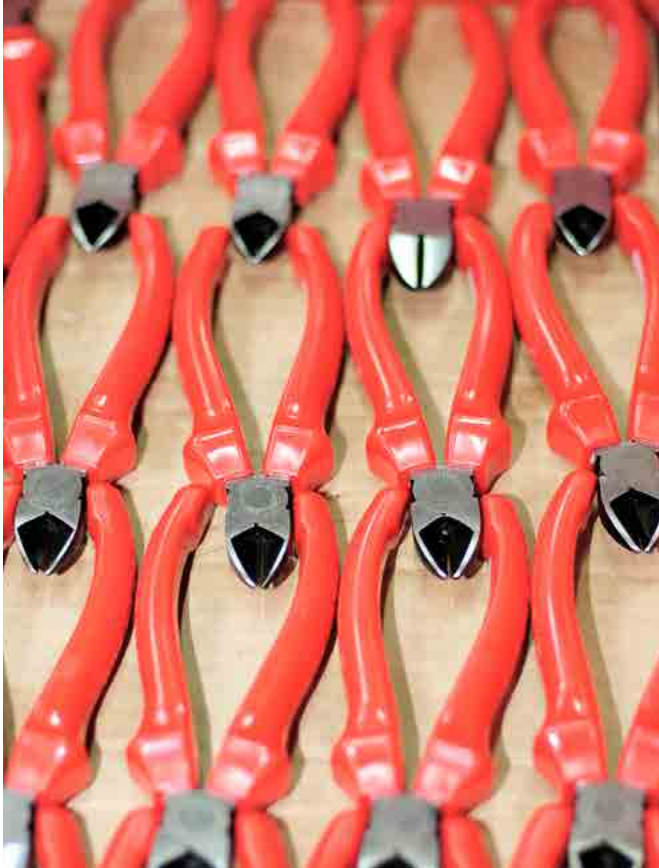

4920

T Tipi Allen Anahtar (mm)
Hex Key Wrench T - Handle (mm)



Krom vanadyum, Krom kaplı, PP saplı
Chrom vanadium, Chrom plated, PP handle

KOD CODE	mm	L mm	L1 mm	g	TL/Ad.
4920 22 0025	2.5	110	14	20	5 14,44
4920 22 0030	3	125	17	23	5 14,64
4920 22 0040	4	140	20	45	5 16,47
4920 22 0050	5	155	23	58	5 17,62
4920 22 0060	6	170	26	100	5 20,15
4920 22 0070	7	185	30	125	5 21,14
4920 22 0080	8	200	34	150	5 21,70
4920 22 0100	10	220	40	240	5 37,71

4920

T Tipi Allen Anahtar Takımı (8 Parça, mm)
Hex Key Wrench T - Handle Set (8 Pcs, mm)



KOD CODE	İÇERİK CONTENTS	g	TL/Ad.
4920 00 8108	2.5 - 3 - 4 - 5 6 - 7 - 8 - 10	760	8 163,87

4921

Yuvarlak Başlı T Tipi Allen Anahtar (mm)
Hex Key Wrench T - Handle Ballpoint (mm)

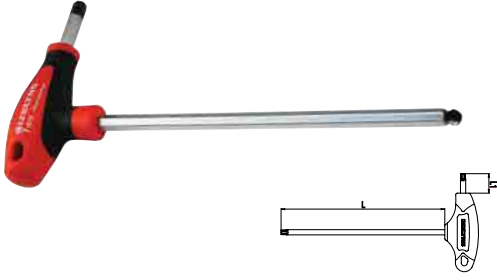

Krom vanadyum, Krom kaplı, PP saplı
Chrom vanadium, Chrom plated, PP handle

KOD CODE	mm	L mm	L1 mm	g		TL/Ad.
4921 22 0025	2.5	110	14	20	5	18,74
4921 22 0030	3	125	17	23	5	19,00
4921 22 0040	4	140	20	45	5	21,40
4921 22 0050	5	155	23	58	5	22,91
4921 22 0060	6	170	26	100	5	26,20
4921 22 0070	7	185	30	125	5	27,47
4921 22 0080	8	200	34	150	5	28,22
4921 22 0100	10	220	40	235	5	49,01

4921

Yuvarlak Başlı T Tipi Allen Anahtar Takımı (8 Parça, mm)
Hex Key Wrench T - Handle Ballpoint Set (8 Pcs, mm)



KOD CODE	İÇERİK CONTENTS	g		TL/Ad.
4921 00 8108	2.5 - 3 - 4 5 - 6 - 7 - 8 - 10	755	8	212,95

4

TSE

ENERJİ YÖNETİM SİSTEMİ BELGESİ ENERGY MANAGEMENT SYSTEM CERTIFICATE



TÜRK STANDARLARI ENSTİTÜSÜ
bu belge ile

İZELTAŞ İZMİR ELEKTRİK ALETLERİ SAN. VE TİC. A.Ş.
KEMALPAŞA CAD. NO:303 İŞIKKENT - BORNOVA
İZMİR / TÜRKİYE

TURKISH STANDARDS INSTITUTION
hereby certifies that the organization

İZELTAŞ İZMİR ELEKTRİK ALETLERİ SAN. VE TİC. A.Ş.
KEMALPAŞA CAD. NO:303 İŞIKKENT - BORNOVA
İZMİR / TÜRKİYE



Belge kapsamı Ek'te verilmiştir

Scope of the certificate is given in annex
Belge No / Certificate No

EYB-082/15

Belge Tarihi / Date of Certificate
04.12.2015

Geçerlilik Tarihi / Valid Until
04.12.2018

Revizyon Tarihi / Date of Revision
04.12.2015

İlk Belge Tarihi / Initial Certification Date
04.12.2015

Bu belge belgeleme sürecine
uygunluk sağlanmıştır. Sürücü geçerlidir.

Bu belge, Türk Standardları Enstitüsü'nün kuruluşu hakkındaki 132 sayılı kanun uyarınca verilmiştir.
This certificate is issued in accordance with the Law No. 132 establishing Turkish Standards Institution.

350912201502321871

Keskiler ve ekiler

Chisels and Hammers

5

Iskarpelalar
Keskiler
Zimbalar
ekiler
Keserler

Chisels
Punches
Hammers
Adzes



5010

Iskarpela (Düz)
Wood Chisel



Özel alaşımlı çelik, Uç indüksiyonda sertleştirilmiş, PP Saplı
Special steel, induction hardened tips, PP Handle

KOD CODE	a mm	L mm	L1 mm	g	TL/Ad.
5010 23 0006	6	273	153	115	30,65
5010 23 0008	8	273	153	125	32,79
5010 23 0010	10	273	153	135	34,63
5010 23 0012	12	273	153	135	38,06
5010 23 0014	14	273	153	145	39,39
5010 23 0016	16	273	153	150	42,11
5010 23 0018	18	273	153	160	45,71
5010 23 0020	20	273	153	170	50,79
5010 23 0022	22	273	153	190	55,01
5010 23 0024	24	273	153	195	59,48
5010 23 0026	26	273	153	200	61,62
5010 23 0028	28	273	153	200	63,72
5010 23 0030	30	275	155	205	65,78

5010

Iskarpela Takım (6 parça)
Wood Chisel Set (6 Pcs)



KOD CODE	İÇERİK CONTENTS	g	TL/Ad.
5010 00 8106	10 - 12 - 14 16 - 18 - 20	985	6 250,69



5500

Düz Keski
Flat Cold Chisel

TS 492 • DIN 6453

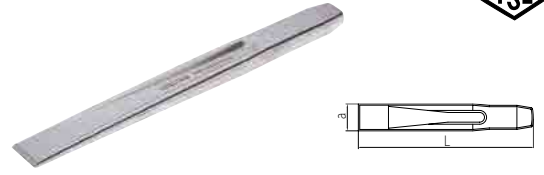

Özel alaşımlı çelik, Krom kaplı
Special steel, Chrom plated

KOD CODE	L mm	a mm	g	TL/Ad.
5500 23 0100	100	17	75	5 14,72
5500 23 0125	125	19	110	5 19,36
5500 23 0150	150	21	180	5 24,94
5500 23 0175	175	24	245	5 28,16
5500 23 0200	200	27	340	5 39,22
5500 23 0250	250	30	525	5 48,22
5500 23 0300	300	30	635	5 77,31

5500

Düz Keski (Kalkan İzoleli)
Flat Cold Chisel (With Safety Handle)

TS 492 • DIN 6453

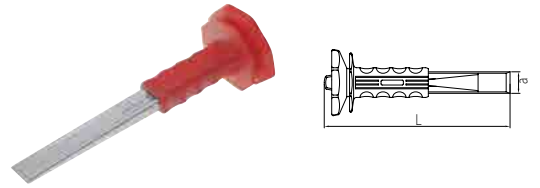

Özel alaşımlı çelik, Krom kaplı
Special steel, Chrom plated

KOD CODE	L mm	a mm	g	TL/Ad.
5500 23 1250	250	30	700	1 64,27
5500 23 1300	300	30	790	1 93,81

5510

Tesviyeci Düz Keski
Flat Cold Chisel Octagonal

TS 492 • DIN 6453

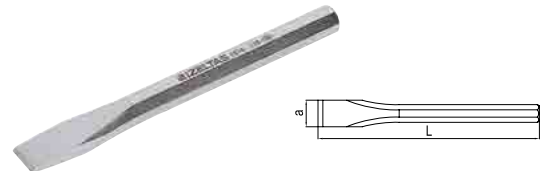

Krom vanadyum, Krom kaplı
Chrom vanadium, Chrom plated

KOD CODE	L mm	a mm	mm	g	TL/Ad.
5510 23 0125	125	10	10	75	10 24,32
5510 23 0150	150	14	12	125	10 25,86

5520

Tırnak Keski Cross Cut Chisel



Krom vanadyum, Krom kaplı
Chrom vanadium, Chrom plated

KOD CODE	L mm	a mm	mm	g	TL/Ad.
5520 23 0125	125	5	10	70	27,24
5520 23 0150	150	6	12	110	29,52

5540

Nokta Zimba Center Punch

TS 2338 • DIN 7250

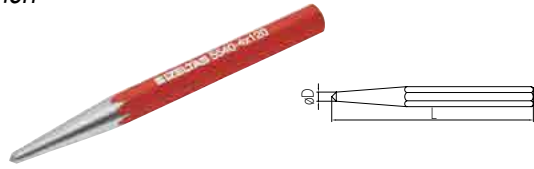

Krom vanadyum, Elektrostatik boyanmış
Chrom vanadium, Electrostatically painted

KOD CODE	L mm	L inch	øD mm	mm	g	TL/Ad.
5540 24 4120	120	4 3/4"	4	10	65	16,04
5540 24 5120	120	4 3/4"	5	12	95	18,00
5540 24 5150	150	6"	5	12	115	19,13
5540 24 0412	120	4 3/4"	4	10	65	16,60

5545

Konik Pim Zimba Drift Punch

TS 2338 • DIN 6458



Krom vanadyum, Elektrostatik boyanmış
Chrom vanadium, Electrostatically painted

KOD CODE	L mm	L inch	øD mm	mm	g	TL/Ad.
5545 24 0002	120	4 3/4"	2	12	90	16,10
5545 24 0003	120	4 3/4"	3	12	90	17,50
5545 24 0004	120	4 3/4"	4	12	90	19,69
5545 24 0005	120	4 3/4"	5	12	95	20,11
5545 24 0006	120	4 3/4"	6	12	95	29,72
5545 24 0007	120	6"	7	12	100	30,94
5545 24 0008	150	6"	8	12	125	32,18
5545 24 0009	150	6"	9	12	130	32,88
5545 24 0010	150	6"	10	12	130	33,55
5545 24 0012	150	6"	12	14	180	35,05
5545 24 0103	120	4 3/4"	3	12	90	18,30

5550

Düz Pim Zimba Split Pin Punch

TS 2338 • DIN 6450

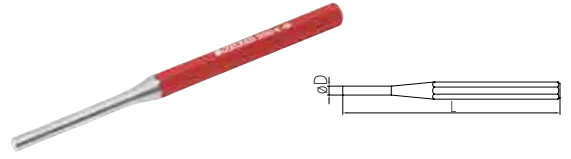

Krom vanadyum, Elektrostatik boyanmış
Chrom vanadium, Electrostatically painted

KOD CODE	L mm	L inch	øD mm	mm	g	TL/Ad.	
5550 24 0002	150	6"	2	10	70	5	18,15
5550 24 0003	150	6"	3	10	65	5	18,37
5550 24 0004	150	6"	4	10	65	5	18,37
5550 24 0005	150	6"	5	10	65	5	18,41
5550 24 0006	150	6"	6	10	70	5	19,98
5550 24 0007	150	6"	7	12	100	5	20,86
5550 24 0008	150	6"	8	12	105	5	22,31
5550 24 0009	150	6"	9	12	110	5	22,61
5550 24 0010	150	6"	10	12	120	5	22,83
5550 24 0105	150	6"	5	10	65	5	18,66

5600

Keski Zimba Takımı Chisel And Punch Set



KOD CODE	İÇERİK CONTENTS	g	TL/Ad.
5600 00 6106	125 tevsiyecı düz keski 150 tevsiyecı düz keski 125 tırnak keski 4x120 nokta zimba 5x150 düz pim zimba 3x120 konik pim zimba	125 Flat Cold Chisel Octagonal 150 Flat Cold Chisel Octagonal 125 Cross Cut Chisel 4x120 Center Punch 5x150 Split Pin Punch 3x120 Drift Punch	865 6 130,98

5700
Kayış Zimba
Belt Punch

DIN 7200

TSEK

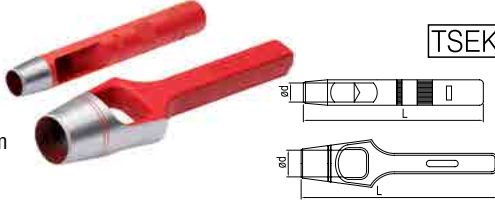
 3-20mm
 21-32mm

 Krom vanadyum, Elektrostatik boyanmış
 Chrom vanadium, Electrostatically painted

KOD CODE	ØD mm	L mm	g	TL/Ad.	
5700 24 0003	3	105	35	10	14,96
5700 24 0004	4	105	40	10	15,69
5700 24 0005	5	110	50	10	17,06
5700 24 0006	6	110	60	10	17,35
5700 24 0007	7	115	75	10	19,11
5700 24 0008	8	115	90	10	20,34
5700 24 0009	9	120	100	10	22,70
5700 24 0010	10	120	110	10	24,20
5700 24 0011	11	125	130	5	26,00
5700 24 0012	12	125	165	5	31,17
5700 24 0013	13	130	165	5	32,79
5700 24 0014	14	130	180	5	36,05
5700 24 0015	15	135	245	5	41,36
5700 24 0016	16	135	300	5	45,29
5700 24 0017	17	140	365	5	49,56
5700 24 0018	18	140	380	5	54,08
5700 24 0019	19	145	405	5	58,81
5700 24 0020	20	145	450	5	62,60
5700 24 1021	21	150	250	5	63,15
5700 24 1022	22	150	260	5	66,26
5700 24 1023	23	160	305	5	71,02
5700 24 1024	24	160	320	5	75,63
5700 24 1025	25	170	365	5	79,60
5700 24 1026	26	170	355	5	83,90
5700 24 1027	27	180	415	5	88,43
5700 24 1028	28	180	420	5	94,00
5700 24 1029	29	190	465	5	95,35
5700 24 1030	30	190	475	5	96,70
5700 24 1032	32	190	500	5	102,25

5700
Kayış Zimba Takımı
Belt Punch Set

KOD CODE	İÇERİK CONTENTS	g	TL/Ad.	
5700 00 2108	3 - 4 - 5 - 6 - 7 - 8 - 9 - 10	555	8	151,41
5700 00 2110	3 - 4 - 5 - 6 - 7 8 - 9 - 10 - 11 - 12	845	10	208,58
5700 00 2112	3 - 4 - 5 - 6 - 7 - 8 - 9 10 - 11 - 12 - 13 - 14	1180	12	277,42

5800
Tesviyei Çekiç
Machinist's Hammer

TS 5 • DIN 1041

TSE

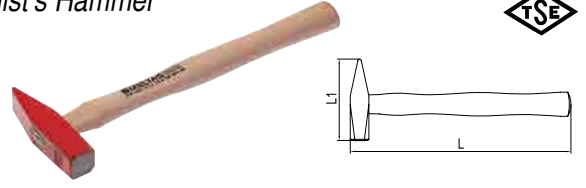
 Özel alaşımli çelik, İndüksiyonda sertleştirilmiş, Elektrostatik boyanmış
 Special steel, Induction hardened, Electrostatically painted

KOD CODE	L mm	L1 mm	g	g	TL/Ad.	
5800 25 0100	260	82	100	160	10	19,50
5800 25 0200	280	95	200	260	10	26,32
5800 25 0300	300	105	300	395	10	32,08
5800 25 0500	320	118	500	600	5	40,56
5800 25 0800	350	130	800	950	5	-----
5800 25 1000	360	135	1000	1095	5	62,29
5800 25 1500	380	145	1500	1630	5	84,70
5800 25 2000	400	155	2000	2100	5	104,21

5800
Çekiç Sapı (Kamalı)
Hammer Handle (With Pin)

TS 5 • DIN 5111



KOD CODE	L mm	g	TL/Ad.	
5800 25 0001	260	60	10	8,57
5800 25 0002	280	60	10	8,67
5800 25 0003	300	95	10	9,68
5800 25 0005	320	100	10	10,92
5800 25 0008	350	145	10	-----
5800 25 0010	360	165	10	13,75
5800 25 0015	380	185	10	15,87
5800 25 0020	400	205	10	17,17

5820
Çamcı Çekici
Glaziers Hammer

TSEK

 Özel alaşımli çelik, İndüksiyonda sertleştirilmiş, Elektrostatik boyanmış
 Special steel, Induction hardened, Electrostatically painted

KOD CODE	L mm	L1 mm	g	g	TL/Ad.	
5820 25 0125	300	110	125	160	10	28,66

5820

Camcı Çekici Sapı (Kamalı)
Glaziers Hammer Handle (With Pin)



KOD CODE	L mm	g		TL/Ad.
5820 25 0012	300	35	10	8,57

5850

Plastik Çekiç
Plastic Hammer

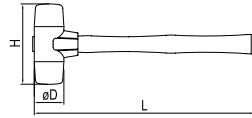

TS 5



Darbeye dayanıklı selüloz asetat başlık, Kolay değiştirilebilir
Made from cellulose acetate, Durable and easily changeable heads

KOD CODE	L mm	øD mm	H mm	g		TL/Ad.
5850 25 0030	300	30	100	345	5	48,68
5850 25 0040	320	40	110	645	5	60,05
5850 25 0050	350	50	120	1015	5	75,06

5850

Başlık
Head

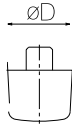

KOD CODE	øD mm	g		TL/Ad.
5850 25 0130	30	35	10	10,55
5850 25 0140	40	70	10	15,16
5850 25 0150	50	120	10	21,79

5870

Lastik Çekiç
Rubber Hammer

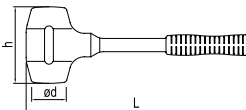

KOD CODE	L mm	ød mm	h mm	g	g		TL/Ad.
5870 25 0400	300	47	104	400	610	5	50,52

6400

Keser
Adze

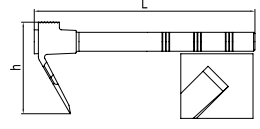

Özel alaşımli çelik, İndüksiyonda sertleştirilmiş,
Elektrostatik boyanmış, PVC ağız koruyucu
Special steel, Induction hardened, Electrostatically painted,
PVC cutting edge protector

KOD CODE	L mm	h mm	g	g		TL/Ad.
6400 25 0600	400	125	400	550	5	63,60

6401

Usta Keseri
Master Adze

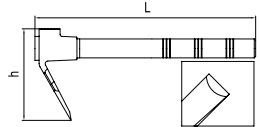

Özel alaşımli çelik, İndüksiyonda sertleştirilmiş,
Elektrostatik boyanmış, PVC ağız koruyucu
Special steel, Induction hardened, Electrostatically painted,
PVC cutting edge protector

KOD CODE	L mm	h mm	g	g		TL/Ad.
6401 25 0600	400	125	400	540	5	63,60

6400

Keser Sapı
Adze Handle



KOD CODE	L mm	g		TL/Ad.
6400 25 0001	400	140	10	7,12



Servis Alet ve Ekipmanları

6

Maintance Tools and Equipment

Servis Aletleri
Perçin Tabancası
İşkenceler
İnşaat Ekipmanları
Metreler

Service Equipment
Riveting Pliers
Clamps
Construction Equipment
Measuring Tapes



03751

Koaksiyel Kablo Sıyrıcı
Cable Strippers



KOD CODE	ÖLÇÜ SIZE	g	□	TL/Ad.
03751 50 012	Dış (1) İç (2)	20	5	45,44

03752

Kablo Sıyrıcı
Cable Strippers



KOD CODE	ÖLÇÜ SIZE	g	□	TL/Ad.
03752 50 625	Tek 6/300 Çok 1.5/25	70	5	31,82

03753

Mekanik Kablo Sıyrıcı
Cable Strippers



KOD CODE	ÖLÇÜ SIZE	g	□	TL/Ad.
03753 50 054	0.5/4	100	5	59,88

03754

İnce Kablo Sıyrıcı
Cable Strippers



KOD CODE	ÖLÇÜ SIZE	g	□	TL/Ad.
03754 50 258	0.25/0.8	40	5	115,63

05881

Plastik, Krom Şerit Metre
Plastic, Chrom Case Steel, Measuring tapes

TS 9505



KOD CODE	ÖLÇÜ SIZE	g	MODEL	□	TL/Ad.
05881 50 003	3	145	Plastik/Plastic	5	14,30
05881 50 005	5	200	Plastik/Plastic	5	17,16
05881 50 013	3	160	Krom/Chrom	5	17,05
05881 50 015	5	220	Krom/Chrom	5	19,25

05885

Lazer Metre Digital Göstergeli
Digital Laser Meter



KOD CODE	ÖLÇÜ SIZE M	g	□	TL/Ad.
05885 50 040	40	65	1	497,15

05886

Arazi Tipi Fiberglas Şerit Metre
Fiberglass Measuring Tape Field Type



KOD CODE	ÖLÇÜ SIZE M	g	□	TL/Ad.
05886 50 130	30	445	1	50,55

05886

Arazi Tipi Fiberglas Şerit Metre (Saplı)
Fiberglass Measuring Tape Field Type (With Holder)



KOD CODE	ÖLÇÜ SIZE M	g		TL/Ad.
05886 50 020	20	520	1	45,82
05886 50 030	30	585	1	48,90
05886 50 050	50	820	1	78,62

05880

Su terazisi
Straight Level



Alüminyum gövde
Aluminyum body

KOD CODE	L mm	g		TL/Ad.
05880 50 040	400	250	5	41,42
05880 50 050	500	300	5	44,99
05880 50 060	600	350	5	48,84
05880 50 070	700	400	5	52,50
05880 50 080	800	450	5	56,65

05887

Kumpas
Vernier

TS 6906



Sürgülü, Stoplu
Slider and with stop

KOD CODE	L mm	g		TL/Ad.
05887 50 150	150	155	5	111,03

05888

Çelik Gönye
Square



Özel alaşımlı çelikten yapılmış
Made from special alloyed steel

KOD CODE	L cm	g		TL/Ad.
05888 50 030	30	180	10	56,84

05882

Çelik Metre
Steel Rule



KOD CODE	L cm	g		TL/Ad.
05882 50 030	30	60	10	28,30
05882 50 050	50	100	10	50,06

05890

Testere Kolu
Hacksaw Frame

DIN 6473



KOD CODE	L mm	g		TL/Ad.
05890 50 830	300	540	5	49,47

05895

Kıl Testere Kolu (Ağaç saplı)
Hacksaw Frame (Wooden Handle)

DIN 6473



KOD CODE	L mm	g		TL/Ad.
05895 50 150	150	95	10	10,74

05898

HSS Testere Laması
Hacksaw Blade HSS

DIN 6494



KOD CODE	ÖLÇÜ SIZE	g	□	TL/Ad.
05898 50 283	13x0.65x18	20	100	5,57

05899

Bimetal Testere Laması
Hacksaw Blade Bimetal

DIN 6494



KOD CODE	ÖLÇÜ SIZE	g	□	TL/Ad.
05899 50 283	13x0.65x18	20	100	6,90

05901

Sentil 20 Parça (mm)
Feeler Gauges 20 pcs (mm)



KOD CODE	ÖLÇÜ SIZE mm	g	□	TL/Ad.
05901 50 020	0.05 - 1	90	10	16,30

05902

Sentil 20 Parça (SAE)
Feeler Gauges 20 pcs (SAE)



KOD CODE	ÖLÇÜ SIZE inch	g	□	TL/Ad.
05902 50 020	2 - 35/1000"	65	10	30,58

6195

Perçin Tabancası
Riveting Pliers



KOD CODE	ÖLÇÜ SIZE	CAPACITY mm	g	□	TL/Ad.
6195 26 0260	260	2.5 - 3.2 - 4 - 4.8	625	1	73,77

6195

Perçin Tabancası Set
Riveting Pliers Set

DIN 6494



KOD CODE	İÇERİK CONTENTS	ÖLÇÜ SIZE	g	□	TL/Ad.
6195 00 1260	4x10 (50) 4x12 (50) 4x15 (50) 4x20 (50)	260	2150	1	100,65

6215

Balans Pensi
Wheel Weight Pliers



KOD CODE	L mm	L inch	g	□	TL/Ad.
6215 15 0250	250	10	350	5	101,30



6

6220

Spiralli Miknatıs
Flexible Magnet Holder

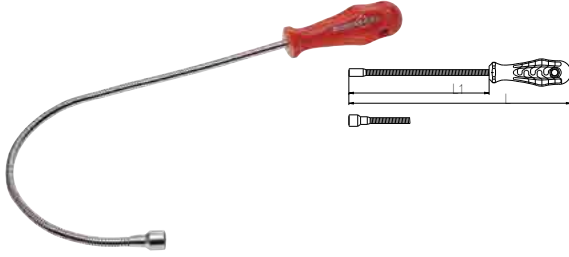

KOD CODE	ÖLÇÜ	L mm	L1 mm	g	TL/Ad.
6220 26 0100	100	190	100	45	-----
6220 26 0500	500	465	375	100	51,57
6220 26 1000	1000	465	375	105	54,58

6225

Madeni Yağdanlık (Flexible Uçlu)
Oiler With Flexible Spout



KOD CODE	ÖLÇÜ SIZE cc	g	TL/Ad.
6225 26 0200	200	170	5, 30,57
6225 26 0300	300	200	5, 34,43
6225 26 0500	500	225	5, 37,71

6230

Gres Pompası
Grease Gun



KOD CODE	ÖLÇÜ SIZE cc	g	TL/Ad.
6230 26 0300	300	1200	1, 46,68
6230 26 0500	500	1320	1, 56,67

6230

Gres Pompası Ucu
Grease Gun Nozzle



KOD CODE	L mm	ø mm	g	TL/Ad.
6230 26 2500	38	15	31	10, 4,28

6230

Gres Pompası Hortumu
Grease Gun



KOD CODE	ø mm	L mm	g	TL/Ad.
6230 26 3300	8	300	34	10, 5,97
6230 26 3500	12	300	102	10, 10,32

6240

Tapa Anahtarı (İki ağız)
Offset Wrench For Carter Case



KOD CODE	ÖLÇÜ mm	g	TL/Ad.
6240 26 0810	8x10	250	10, 37,00

6245

Tapa Anahtarı
Offset Wrench For Carter Case



Krom vanadyum, Krom kaplı
Chrom vanadium, Chrom plated

KOD CODE	ÖLÇÜ SIZE mm	g	TL/Ad.
6245 26 0719	5x19 8.5 - 10.5 - 11.5 - 12.5 - 17 6.5x7.2 - 8.9 - 9.4x10.5 15.8x16.6	410	5, 53,94

6235

Sübab Ayar Tornavidası
Valve Adjustment Spinner



KOD CODE	L mm	g		TL/Ad.
6235 19 0220	220	90	10	21,90

6350

Levye Oluklu
Tyre Lever, Straight



TSEK

Krom vanadyum, Krom kaplı
Chrom vanadium, Chrom plated

KOD CODE	L mm	L inch	g		TL/Ad.
6350 26 0300	300	12"	265	5	23,39
6350 26 0400	400	16"	440	5	32,07
6350 26 0500	500	20"	675	5	41,23
6350 26 0600	600	24"	900	5	50,34

6360

Levye Oluklu Kıvrık Uçlu
Tyre Lever, Bent



TSEK

Krom vanadyum, Krom kaplı
Chrom vanadium, Chrom plated

KOD CODE	L mm	L inch	g		TL/Ad.
6360 26 0600	600	24"	910	5	60,52

6370

Yağ Filtresi Sökeceği
Band Type Oil Filter Wrench



KOD CODE	Ø mm	g		TL/Ad.
6370 26 0100	75 - 100	335	5	36,18

6371

Üç Ayaklı Yağ Filtresi Sökeceği
Oil Filter Hook 3 Arms Pattern



KOD CODE	Ø mm	g		TL/Ad.
6371 26 3120	63 - 120	700	5	58,04

06373

Kayırlı Yağ Filtresi Sökeceği
Strap Wrench



KOD CODE	Ø mm	g		TL/Ad.
06373 50 140	60x140	245	5	67,42

06374

Zincirli Yağ Filtresi Sökeceği
Chain Wrench



KOD CODE	Ø mm	g		TL/Ad.
06374 50 140	60x140	390	5	54,16

06375

Ayarlı Yağ Filtresi Sökeceği
Adjustable Slot Type Oil Filter Wrench



KOD CODE	Ø mm	g	TL/Ad.
06375 50 100	100	215	5 26,38

06376

Sac Yağ Filtresi Sökeceği
Oil Filter Wrench



KOD CODE	Ø mm	inch	g	TL/Ad.
06376 50 108	108	3/8"	240	5 16,91

06377

Yağ Filtresi Sökeceği Seti (30 Parça)
30 Pcs. Cup type Oil Filter Wrench Kit



KOD CODE	Ø mm	İÇERİK CONTENTS	g	TL/Ad.
06377 00 030	65 - 120	28 Parça Karartmalı Sac Yağ Filtresi Sökeceği Ø65 - 108 mm, 28 Pcs Oil Filter Wrench Ø65 - 108 mm, 1 Adet Üç Ayaklı Yağ Filtresi Sökeceği Ø65 120mm./ Oil Filter Hooks 3 Arms 120 mm 1 Adet 1/2"Fx3/8"M Adaptör 1Pcs Adapter 1/2"Fx3/8"M	7350	1 527,85

06380

Sübab Çektirme (Çift Çeneli)
Valve Spring Compressor (With 2 Spare Jaws)



KOD CODE	L mm	L inch	g	TL/Ad.
06380 50 006	150	6"	1300	1 138,16

06390

Segman Çemberi
Piston Ring Compressor

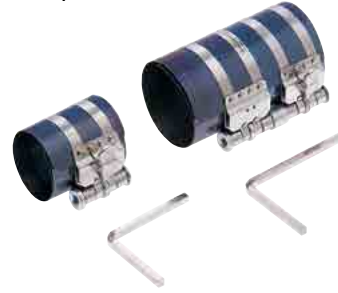

KOD CODE	Ø mm	g	TL/Ad.
06390 50 125	125	235	5 54,34
06390 50 175	175	505	5 96,32

06385

Yengeç Tipi Piston Segman Pensi
Piston Ring Pliers



KOD CODE	Ø mm	g	TL/Ad.
06385 50 100	100	240	5 64,25

07415

Sıralı Tel Fırça (Ağaç Saplı)
Hand Brush (Wooden Handle)



KOD CODE	ÖLÇÜ SIZE		g	TL/Ad.
07415 50 003	3 SIRA	3 RAWS	125	5,73
07415 50 004	4 SIRA	4 RAWS	135	6,03
07415 50 005	5 SIRA	5 RAWS	145	6,74
07415 50 006	6 SIRA	6 RAWS	170	7,26

07416

Kıvrık Uçlu Fırça (Plastik Saplı)
Hand Brush (PP Handle)



KOD CODE	ÖLÇÜ SIZE	g	TL/Ad.
07416 50 001	270	110	5,97

7300

İşkence (Marangoz Mengenesi Plastik Ağızlı)
Carpenter Screw Clamp

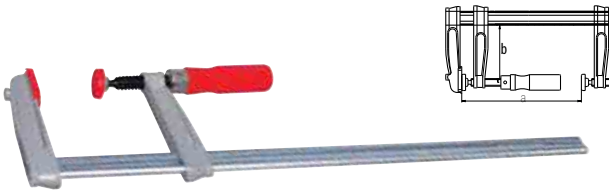

Çekişlenebilir döküm çeneler
Malleable cast iron jaws

KOD CODE	a mm	b mm	g	TL/Ad.
7300 30 3012	30x12	300	120	1605
7300 30 4012	40x12	400	120	1780
7300 30 5012	50x12	500	120	1935
7300 30 6012	60x12	600	120	2080
7300 30 8012	80x12	800	120	2470
7300 30 1012	100x12	1000	120	2790

7300

İşkence Sehpası (Dolu)
Display For Screw Clamp Set (Full)



KOD CODE	İÇERİK CONTENTS	g	TL/Ad.
7300 00 6150	30x12 - 40x12 50x12 - 60x12 80x12 - 100x12	108400	4529,04

7310

Mini İşkence
Mini Clamp



Alaşımli alüminyum çeneler
Alloyed aluminum jaws

KOD CODE	a mm	b mm	g	TL/Ad.
7310 30 1005	10x5	100	50	250
7310 30 1505	15x5	150	50	280
7310 30 2005	20x5	200	50	310
7310 30 2505	25x5	250	50	330
7310 30 3005	30x5	300	50	360

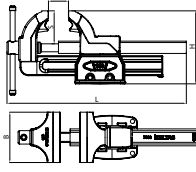
7400
Dövme Çelik Mengene
Forged Steel Vice

Özel alaşım çelik, Fırın boyu
Special steel, Electrostatic Paint

KOD CODE	B mm	W mm	H mm	L mm	g	TL/Ad.
7400 30 0100	100	125	148	440	5000	1 455,40
7400 30 0125	125	155	183	550	11000	1 627,00
7400 30 0150	150	180	220	675	20000	1 801,90
7400 30 0175	175	205	245	760	29000	1 986,70

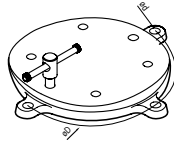
7401
Mengene Döner Tablası
Swivel Base of Vice

Özel alaşım çelik, Krom kaplı
Special steel, Chrom plated

KOD CODE	ÖLÇÜ SIZE	ød mm	øD mm	g	TL/Ad.
7401 30 0100	100	10.5	170	1550	1 145,64
7401 30 0125	125	12.5	200	2700	1 192,50
7401 30 0150	150	12.5	240	3800	1 233,75
7401 30 0175	175	12.5	280	6650	1 264,22

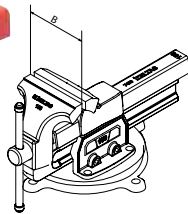
7400
Dövme Çelik Mengene (Döner Tabla dahil)
Forged Steel Vice with Swivel Base

Özel alaşım çelik, Fırın boyu
Special steel, Electrostatic Paint

KOD CODE	B mm	g	TL/Ad.
7400 00 0100	100	6550	1 601,04
7400 00 0125	125	13700	1 819,50
7400 00 0150	150	23800	1 1035,65
7400 00 0175	175	35650	1 1250,92

8004
Dövme Çelik Mengene Sehpası
Forged Steel Vice Frame

KOD CODE	İÇERİK CONTENTS	g	TL/Ad.
8004 00 6004	100 - 125 150 - 175	79700	4 3228,35

07420
Basınçlı Hava Hortumu
Compressed Airtube Reels

KOD CODE	ÖLÇÜ SIZE	BASINÇ BAR	g	TL/Ad.
07420 50 020	20 m.	10	4760	1 335,91



07410

Makaralı Uzatma Kablosu Extension Cord Reel



el tipi/with handle ayaklı/with stand

KOD CODE	MODEL	ÖLÇÜ SIZE	g	TL/Ad.
07410 50 010	el tipi/with handle	10	1400	99,26
07410 50 025	ayaklı/with stand	25	4130	198,52
07410 50 050	ayaklı/with stand	50	6745	277,92





Product Service

CERTIFICATE

No. Z1A 13 03 44987 014

Holder of Certificate: **IZELTAS Izmir El Aletleri
San. ve. Tic. A.S.**

Kemalpasa Cad. No. 41 ISIKKENT
35070 Izmir
TURKEY

Factory(ies): 44987

Certification Mark:



Product: **Combination pliers**

Model(s): **TS-60-180, Art.-Nr. 3020 12 0180 (super insolated)
TS-60-200, Art.-Nr. 3020 12 0200 (super insolated)
TS 60-160, Art.-Nr. 3020 12 4160
TS 60-180, Art.-Nr. 3020 12 4180
TS 60-200, Art.-Nr. 3020 12 4200**

Parameters:

Model	Length mm	Width mm	Weight g
3020 12 0180	187	21	342
3020 12 0200	207	22	435
3020 12 4160	170	10/21	230
3020 12 4180	190	11/22	300
3020 12 4200	210	12/23	385

Material: **Steel 41 Cr 4
Steel C 1050
Protefan, PVC**

Tested according to: **DIN ISO 5746:2006
DIN EN 60900:2005
ZEK 01.04-08**

The product meets the safety and health requirements of the German Product Safety Act section 20 to 22 ProdSG. The certification marks shown above can be affixed on the product. It is not permitted to alter the certification marks in any way. In addition the certificate holder must not transfer the certificate to third parties. This certificate is valid until the listed date, unless it is cancelled earlier. See also notes overleaf.

Test report no.: 713020238-01

Valid until: 2018-03-18

Date, 2013-03-20

(Edgar Harnisch)

Page 1 of 1



Makaslar

Shears

7

Demir Kesme Makası
Saç Makasları
Plastik Boru Kesme Makası
Bağ Makasları

Bolt Cutters
Sheet Metal Cutters
Plastic Pipe Cutters
Prunnig Shears



2350

Demir Kesme Makası
Bolt Cutters



Özel alaşımli çelik, Kesici ağızlar indüksiyonda sertleştirilmiş,
Elektrostatik boyanmış çeneler ve bağlantı parçaları dövme
*Special steel, Cutters induction hardened,
Electrostatically painted jaws and connection parts drop forged*

KOD CODE	L mm	L inch	KAPASİTE CAPACITY Ø mm	g	TL/Ad.
2350 27 0018	450	18"	6 - 8	1510	1 198,00
2350 27 0024	600	24"	8 - 10	2350	1 291,50
2350 27 0030	750	30"	9 - 13	3750	1 456,50
2350 27 0036	900	36"	11 - 16	5500	1 590,70

2350

Çene
Jaws



KOD CODE	ÖLÇÜ SIZE	KAPASİTE CAPACITY Ø mm	g	TL/Ad.
2350 27 0118	18"	6 - 8	850	1 105,93
2350 27 0124	24"	8 - 10	870	1 137,94
2350 27 0130	30"	9 - 13	1250	1 244,31
2350 27 0136	36"	11 - 16	1850	1 310,20

2350

Demir Kesme Makası Sehpa
Bolt Cutters Frame



KOD CODE	İÇERİK CONTENTS	g	TL/Ad.
2350 00 6104	18"(450) - 24"(600) 30"(750) - 36"(900)	21.11 0	4 1709,40

6205

Alüminyum Ve Sac Kesme Makası Sağ
Snip For Aluminium and Metal Sheet (Right)



Özel alaşımli çelik, Kesici ağızlar indüksiyonda sertleştirilmiş, PVC izoleli
Special steel, Cutters induction hardened, PVC insulated

KOD CODE	L mm	L inch	g	TL/Ad.
6205 27 0240	240	10"	380	5 57,15

6206

Alüminyum Ve Sac Kesme Makası Sol
Snip For Aluminium and Metal Sheet (Left)



Özel alaşımli çelik, Kesici ağızlar indüksiyonda sertleştirilmiş
Special steel, Cutters induction hardened

KOD CODE	L mm	L inch	g	TL/Ad.
6206 27 0240	240	10"	380	5 57,15

6207

Alüminyum Ve Sac Kesme Makası Düz
Snip For Aluminium and Metal Sheet (Flat)



Özel alaşımli çelik, Kesici ağızlar indüksiyonda sertleştirilmiş
Special steel, Cutters induction hardened

KOD CODE	L mm	L inch	g	TL/Ad.
6207 27 0240	240	10"	380	5 57,15

6209

Kaportacı Makası Profesyonel
Punch Snip Professional



Özel alaşımli çelik, Kesici ağızlar indüksiyonda sertleştirilmiş
Special steel, Cutters induction hardened

KOD CODE	L mm	L inch	g	TL/Ad.
6209 27 0270	270	11"	465	5 140,39

6210

Kaportacı Makası (Sağ)
Punch Snip (Right)

DIN 6438



Özel alaşımli çelik, Kesici ağızlar indüksiyonda sertleştirilmiş, PVC izoleli
Special steel, Cutters induction hardened, PVC insulated

KOD CODE	L mm	L inch	g	TL/Ad.
6210 27 0250	250	10"	555	76,91
6210 27 0275	275	11"	600	84,10
6210 27 0300	300	12"	640	100,84

6211

Kaportacı Makası (Sol)
Punch Snip (Left)

DIN 6438



Özel alaşımli çelik, Kesici ağızlar indüksiyonda sertleştirilmiş, PVC izoleli
Special steel, Cutters induction hardened, PVC insulated

KOD CODE	L mm	L inch	g	TL/Ad.
6211 27 0250	250	10"	535	76,91
6211 27 0275	275	11"	605	84,10
6211 27 0300	300	12"	665	100,84

6820

Tenekeci Makası
Tinman's Snip

TSEK



Özel alaşımli çelik, Kesici ağızlar indüksiyonda sertleştirilmiş, PVC izoleli
Special steel, Cutters induction hardened, PVC insulated

KOD CODE	L mm	L inch	g	TL/Ad.
6820 27 0200	200	8"	320	64,11
6820 27 0250	250	10"	575	74,43
6820 27 0300	300	12"	870	89,29

6821

Tenekeci Makası (Yaylı)
Tinman's Snip (With Spring)

TSEK



Özel alaşımli çelik, Kesici ağızlar indüksiyonda sertleştirilmiş, PVC izoleli
Special steel, Cutters induction hardened, PVC insulated

KOD CODE	L mm	L inch	g	TL/Ad.
6821 27 0250	250	10"	575	80,87
6821 27 0300	300	12"	895	97,36

6800

Kuyumcu Makası (Düz)
Jeweller's Snips (Straight)



KOD CODE	L mm	L inch	g	TL/Ad.
6800 27 0180	180	7 1/8"	140	57,84

6801

Kuyumcu Makası (Eğri)
Jeweller's Snips (Curved)



KOD CODE	L mm	L inch	g	TL/Ad.
6801 27 0180	180	7 1/8"	140	61,58

6815

Tel Kesme Makası
Bolt Cutter



KOD CODE	L mm	L inch	g	TL/Ad.
6815 27 0200	200	8"	295	26,73

6740

Kombine Makas Multi Purpose Scissors



KOD CODE	L mm	L inch	g	TL/Ad.
6740 27 0140	140	5 1/2"	60	5 42,35
6740 27 0190	190	7 1/2"	120	5 48,00

6710

Bağ Makası (Lüks) Pruning Shears (Lux)

TS 3306



Özel alaşımli çelik, Kesici ağızlar indüksiyonda sertleştirilmiş, PVC izoleli
Special steel, Cutters induction hardened, PVC insulated

KOD CODE	L mm	L inch	g	TL/Ad.
6710 27 0230	230	9"	390	5 62,04

6715

Bağ Makası (Comfort) Pruning Shears (Comfort)



Özel alaşımli çelik, PVC izoleli
Special steel, PVC insulated

KOD CODE	L mm	L inch	g	TL/Ad.
6715 27 0225	225	9"	340	5 60,39

6720

Bağ Makası (Hafif Tip) Pruning Shears (Light)



Alüminyum gövde, PVC izoleli
Aluminum forged body, PVC insulated

KOD CODE	L mm	L inch	g	TL/Ad.
6720 27 0220	220	8 5/8"	265	5 111,47

6712

Elma Makası Plucking Shears (Fruit)



Özel alaşımli çelik, Kesici ağızlar indüksiyonda sertleştirilmiş, PVC izoleli
Special steel, Cutters induction hardened, PVC insulated

KOD CODE	L mm	L inch	g	TL/Ad.
6712 27 0210	210	8 1/4"	365	5 96,54

06760

Plastik Boru Kesme Makası Plastic Pipe Cutter



KOD CODE	Ø mm	g	TL/Ad.
06760 50 042	42	400	5 138,56

6760

Narenciye Makası
Plucking Shears (Citrus)



Özel alaşımlı çelik, Kesici ağızlar indüksiyonda sertleştirilmiş, PVC izoleli
Special steel, Cutters induction hardened, PVC insulated

KOD CODE	L mm	L inch	g		TL/Ad.
6760 27 0125	125	5"	125	5	62,10

6850

Mini Boru Kesici (Bakır ve Alüminyum İçin)
Mini Tube Cutter (For Copper and Aluminum)



KOD CODE	ÖLÇÜ SIZE	g		TL/Ad.
6850 28 0322	1/4" - 7/8"	125	1	42,33

6855

Standart Boru Kesici (Bakır ve Alüminyum İçin)
Standard Tube Cutter (For Copper and Aluminum)



KOD CODE	ÖLÇÜ SIZE	g		TL/Ad.
6855 28 0330	1/8" - 1 1/8"	305	1	56,36

6860

Teleskopik Boru Kesici (Bakır ve Alüminyum İçin)
Telescopic Tube Cutter (For Copper and Aluminum)



KOD CODE	ÖLÇÜ SIZE	g		TL/Ad.
6860 28 0635	1/4" - 1 3/8"	470	1	119,87

6865

Profesyonel Boru Kesici (Çelik İçin)
Professional Tube Cutter (For Steel)



KOD CODE	ÖLÇÜ SIZE	g		TL/Ad.
6865 28 1050	1/8" - 2"	2380	1	281,08

6850

Mini Boru Kesici Bıçağı
Blade For Mini Tube Cutter

Standart Boru Kesici Bıçağı
Blade For Standard Tube Cutter

Teleskopik Boru Kesici Bıçağı
Blade For Telescopic Tube Cutter



KOD CODE	ÖLÇÜ SIZE	g		TL/Ad.
6850 28 1322	1/4" - 1 3/8"	5	10	10,73

6865

Profesyonel Boru Kesici Bıçağı
Blade For Professional Tube Cutter



KOD CODE	ÖLÇÜ SIZE	g		TL/Ad.
6865 28 0150	1/8" - 2"	30	5	27,83



Product Service

CERTIFICATE

No. Z1A 13 03 44987 014

Holder of Certificate: **IZELTAS Izmir El Aletleri
San. ve. Tic. A.S.**Kemalpasa Cad. No. 41 ISIKKENT
35070 Izmir
TURKEY

Factory(ies): 44987

Certification Mark:

Product: **Combination pliers**Model(s):
TS-60-180, Art.-Nr. 3020 12 0180 (super insolated)
TS-60-200, Art.-Nr. 3020 12 0200 (super insolated)
TS 60-160, Art.-Nr. 3020 12 4160
TS 60-180, Art.-Nr. 3020 12 4180
TS 60-200, Art.-Nr. 3020 12 4200

Parameters:

Model	Length mm	Width mm	Weight g
3020 12 0180	187	21	342
3020 12 0200	207	22	435
3020 12 4160	170	10/21	230
3020 12 4180	190	11/22	300
3020 12 4200	210	12/23	385

Material: Steel 41 Cr 4
Steel C 1050
Protefan, PVCTested according to: DIN ISO 5746:2006
DIN EN 60900:2005
ZEK 01.04-08

The product meets the safety and health requirements of the German Product Safety Act section 20 to 22 ProdSG. The certification marks shown above can be affixed on the product. It is not permitted to alter the certification marks in any way. In addition the certificate holder must not transfer the certificate to third parties. This certificate is valid until the listed date, unless it is cancelled earlier. See also notes overleaf.

Test report no.: 713020238-01

Valid until: 2018-03-18

Date, 2013-03-20

(Edgar Harnisch)

Page 1 of 1



Çektirmeler

Pullers

8

Çektirmeler
İç Rulman Çektirmeler
Rotil Çektirmeler
Saplama Sökmeler

Pullers
Inside Pullers
Balljoint Pullers
Stud Inserter and Remover



7010

Standart Çektirme (iki Kollu)
Standard Puller (Two Arms)

TSEK

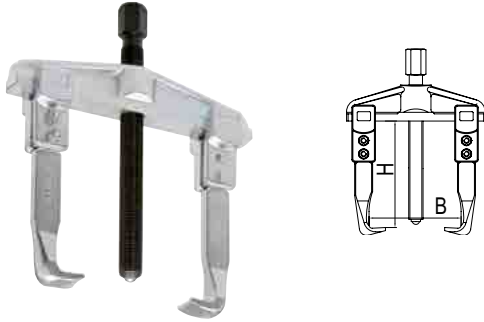

Krom vanadyum, Çinko kaplı, Kollar sertleştirilmiş,
Mil indüksiyonda sertleştirilmiş
Chrom vanadium, Zinc plated,
Arms hardened, Spindle induction hardened

KOD CODE		B mm	H mm	g		TL/Ad.
7010 29 0810	8x10	80	100	1080	1	205,94
7010 29 1210	12x10	120	100	1235	1	220,22
7010 29 1615	16x15	160	150	2850	1	375,49
7010 29 2015	20x15	200	150	3060	1	410,71
7010 29 2520	25x20	250	200	4400	1	709,45
7010 29 3520	35x20	350	200	9900	1	861,65
7010 29 5220	52x20	520	200	13500	1	1266,65

7010

Çektirme Sehpa
Display Frame For Puller



KOD CODE	İÇERİK CONTENTS	g		TL/Ad.
7010 00 6105	8x10 - 12x10 - 16x15 20x15 - 25x20	17840	5	1977,43

7020

Standart Çektirme (Üç Kollu)
Standart Puller (Three Arms)

TSEK

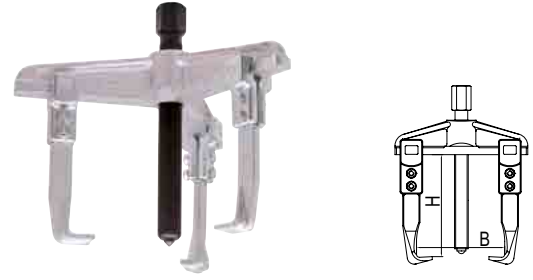

Krom vanadyum, Çinko kaplı, Kollar sertleştirilmiş,
Mil indüksiyonda sertleştirilmiş
Chrom vanadium, Zinc plated,
Arms hardened, Spindle induction hardened

KOD CODE		B mm	H mm	g		TL/Ad.
7020 29 3720	37x20	370	200	13700	1	1590,17
7020 29 5220	52x20	520	200	17815	1	2192,18

7010

Standart Çektirme Uzatma Parçası
Connection Part Long



Krom vanadyum, Çinko kaplı
Chrom vanadium, Zinc plated,

KOD CODE	L mm	KULLANILAN ÇEKTİRME FOR	g		TL/Ad.
7010 29 2033	200	8x10 - 12x10	415	1	52,26
7010 29 3033	300	16x15 - 20x15	890	1	91,07
7010 29 4033	400	25x20 - 35x20 37x20 - 52x20	2350	1	134,84

7010 - 7020

Kol
Arm



KOD CODE	KULLANILAN ÇEKTİRME FOR	g		TL/Ad.
7010 29 0822	8x10 - 12x10	110	1	39,27
7010 29 1622	16x15 - 20x15	330	1	68,46
7010 29 2522	25x20 - 35x20 52x20 - 37x20	775	1	120,14

7010 - 7020

Bağlantı Parçası
Connection Part



KOD CODE	KULLANILAN ÇEKTİRME FOR	g	□	TL/Ad.
7010 29 0833	8x10 - 12x10	160	1	19,73
7010 29 1633	16x15 - 20x15	325	1	34,24
7010 29 2533	25x20 - 35x20	930	1	60,01
	52x20 - 37x20			

7010 - 7020

Mil
Spindle



KOD CODE	KULLANILAN ÇEKTİRME FOR	g	□	TL/Ad.
7010 29 0844	8x10 - 12x10	185	1	35,93
7010 29 1644	16x15 - 20x15	555	1	68,76
7010 29 2544	25x20	1400	1	118,40
7010 29 3544	35x20 - 37x20	2185	1	154,30
7010 29 5244	52x20	3210	1	154,30

7030

Master Çektirme (iki Kollu)
Master Puller (Two Arms)

TSEK



Krom vanadyum, Çinko kaplı, Kollar sertleştirilmiş,
Mil indüksiyonda sertleştirilmiş
Chrom vanadium, Zinc plated,
Arms hardened, Spindle induction hardened

KOD CODE	B mm	H mm	g	□	TL/Ad.
7030 29 0808	8x8	80	545	1	82,85
7030 29 1212	12x12	120	1075	1	171,00
7030 29 1616	16x16	160	1885	1	257,31
7030 29 2320	23x20	230	3240	1	349,95

7040

Master Çektirme (üç Kollu)
Master Puller (Three Arms)

TSEK



Krom vanadyum, Çinko kaplı, Kollar sertleştirilmiş,
Mil indüksiyonda sertleştirilmiş
Chrom vanadium, Zinc plated,
Arms hardened, Spindle induction hardened

KOD CODE	B mm	H mm	g	□	TL/Ad.
7040 29 0808	8x8	80	680	1	158,86
7040 29 1212	12x12	120	1355	1	232,54
7040 29 1616	16x16	160	2320	1	341,95
7040 29 2320	23x20	230	4025	1	460,48

7030 - 7040

Kol
Arm



KOD CODE	KULLANILAN ÇEKTİRME FOR	g	□	TL/Ad.
7030 29 0822	8x8	110	1	21,42
7030 29 1222	12x12	215	1	29,84
7030 29 1622	16x16	345	1	53,34
7030 29 2322	23x20	580	1	72,60

7030 - 7040

Mil
Spindle



KOD CODE	KULLANILAN ÇEKTİRME FOR	g	□	TL/Ad.
7030 29 0844	8x8	180	1	21,43
7030 29 1244	12x12	360	1	42,98
7030 29 1644	16x16	680	1	47,48
7030 29 2344	23x20	1230	1	65,13

7050

Batarya Çektirme (İki Kollu) Battery Puller (Two Arms)

TSEK

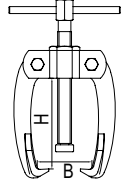

Krom vanadyum, Çinko kaplı, Kollar sertleştirilmiş,
Mil indüksiyonda sertleştirilmiş
Chrom vanadium, Zinc plated,
Arms hardened, Spindle induction hardened

KOD CODE		B mm	H mm	g		TL/Ad.
7050 29 0604	6x4	60	40	245	1	88,17
7050 29 0606	6x6	60	60	275	1	90,90
7050 29 0808	8x8	80	80	555	1	95,54

7060

Batarya Çektirme (Üç Kollu) Battery Puller (Three Arms)

TSEK

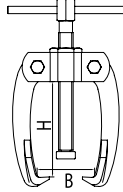

Krom vanadyum, Çinko kaplı, Kollar sertleştirilmiş,
Mil indüksiyonda sertleştirilmiş
Chrom vanadium, Zinc plated,
Arms hardened, Spindle induction hardened

KOD CODE		B mm	H mm	g		TL/Ad.
7060 29 0604	6x4	60	40	300	1	114,49
7060 29 0606	6x6	60	60	345	1	144,46
7060 29 0808	8x8	80	80	715	1	167,53

7050 - 7060

Kol Arm



KOD CODE	KULLANILAN ÇEKTİRME FOR	g		TL/Ad.
7050 29 0422	6x4	40	1	16,70
7050 29 0622	6x6	50	1	18,61
7050 29 0822	8x8	110	1	21,42

7050 - 7060

Mil Spindle



KOD CODE	KULLANILAN ÇEKTİRME FOR	g		TL/Ad.
7050 29 0444	6x4	95	1	19,56
7050 29 0644	6x6	105	1	21,79
7050 29 0844	8x8	200	1	24,40

7070

S Tipi Çektirme (İki Kollu) S Type Puller (Two Arms)

TSEK

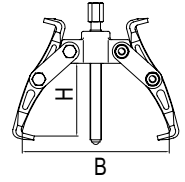

Krom vanadyum, Çinko kaplı, Kollar sertleştirilmiş,
Mil indüksiyonda sertleştirilmiş
Chrom vanadium, Zinc plated,
Arms hardened, Spindle induction hardened

KOD CODE		B mm	H mm	g		TL/Ad.
7070 29 1508	15x8	150	80	850	1	-----
7070 29 2013	20x13	200	130	2420	1	200,00

7080

S Tipi Çektirme (Üç Kollu) S Type Puller (Three Arms)

TSEK

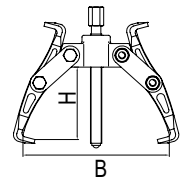

Krom vanadyum, Çinko kaplı, Kollar sertleştirilmiş,
Mil indüksiyonda sertleştirilmiş
Chrom vanadium, Zinc plated,
Arms hardened, Spindle induction hardened

KOD CODE		B mm	H mm	g		TL/Ad.
7080 29 1508	15x8	150	80	1500	1	-----
7080 29 2013	20x13	200	130	3250	1	258,38

7070 - 7080

Kol
Arm



KOD CODE	KULLANILAN ÇEKTİRME FOR	g	TL/Ad.
7070 29 1522	15x8	250	1
7070 29 2022	20x13	405	1

7070 - 7080

Mil
Spindle



KOD CODE	KULLANILAN ÇEKTİRME FOR	g	TL/Ad.
7070 29 1544	15x8	200	1
7070 29 2044	20x13	520	1

7090

Üniversal Çektirme (İki Kollu)
Universal Puller (Two Arms)

TSEK

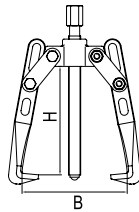

Krom vanadyum, Çinko kaplı, Kollar sertleştirilmiş,
Mil indüksiyonda sertleştirilmiş
Chrom vanadium, Zinc plated,
Arms hardened, Spindle induction hardened

KOD CODE	KULLANILAN ÇEKTİRME FOR	B mm	H mm	g	TL/Ad.
7090 29 0707	7x7	70	70	400	1
7090 29 1010	10x10	100	100	550	1
7090 29 1515	15x15	150	150	1050	1
7090 29 2222	22x22	220	220	3085	1
7090 29 3025	30x25	300	250	5800	1
7090 29 3540	35x40	350	400	6550	1
7090 29 5055	50x55	500	550	7300	1

7100

Üniversal Çektirme (Üç Kollu)
Universal Puller (Three Arms)

TSEK

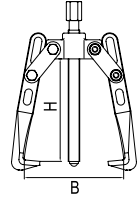

Krom vanadyum, Çinko kaplı, Kollar sertleştirilmiş,
Mil indüksiyonda sertleştirilmiş
Chrom vanadium, Zinc plated,
Arms hardened, Spindle induction hardened

KOD CODE	KULLANILAN ÇEKTİRME FOR	B mm	H mm	g	TL/Ad.
7100 29 0707	7x7	70	70	500	1
7100 29 1010	10x10	100	100	650	1
7100 29 1515	15x15	150	150	1500	1
7100 29 2222	22x22	220	220	4125	1
7100 29 3025	30x25	300	250	7550	1
7100 29 3540	35x40	350	400	8700	1
7100 29 5055	50x55	500	550	9400	1

7090 - 7100

Kol
Arm



KOD CODE	KULLANILAN ÇEKTİRME FOR	g	TL/Ad.
7090 29 0722	7x7	70	1
7090 29 1022	10x10	200	1
7090 29 1522	15x15	400	1
7090 29 2322	22x22	690	1
7090 29 3022	30x25	1040	1
7090 29 3522	35x40	1430	1
7090 29 5022	50x55	1980	1



7090 - 7100

Mil Spindle



KOD CODE	KULLANILAN ÇEKTİRME FOR	g	TL/Ad.
7090 29 0744	7x7	70	1
7090 29 1044	10x10	150	1
7090 29 1544	15x15	200	1
7090 29 2244	22x22	565	1
7090 29 3044	30x25	1345	1
7090 29 3544	35x40	1345	1
7090 29 5044	50x55	2090	1

7120

İç Rulman Çektirme Pensleri - Model A Internal Expansion Puller - Model A



KOD CODE	øD mm	Kullanılan Kol / For	t mm	Adaptör vidası	g	TL/Ad.
7120 29 0507	5 - 7	35 - 75	30	M10	40	139,26
7120 29 0709	7 - 9	35 - 75	30	M10	40	139,26
7120 29 0912	9 - 12	35 - 75	30	M10	40	129,00
7120 29 1013	10 - 13	35 - 75	30	M10	40	129,00
7120 29 1317	13 - 17	35 - 75	50	M10	60	129,00
7120 29 1419	14 - 19	35 - 75	60	M10	75	132,13
7120 29 1621	16 - 21	35 - 75	60	M10	75	132,13
7120 29 1823	18 - 23	35 - 75	60	M10	100	158,25
7120 29 2025	20 - 25	35 - 75	60	M10	100	167,06
7120 29 2530	25 - 30	35 - 75	60	M10	110	174,04
7120 29 3037	30 - 37	35 - 75 60 - 130	70	M10	250	201,66
7120 29 3542	35 - 42	35 - 75 60 - 130	70	M10	250	211,87
7120 29 3845	38 - 45	35 - 75 60 - 130	70	M10	250	223,36
7120 29 4350	43 - 50	35 - 75 60 - 130	70	M10	400	253,98
7120 29 4555	45 - 55	60 - 210	100	G3/8	600	326,08
7120 29 5060	50 - 60	60 - 210	100	G3/8	700	352,90

7120

İç Rulman Çektirme Pensleri - Model B Internal Expansion Puller - Model B

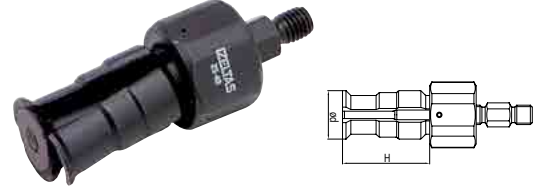

KOD CODE	øD mm	Kullanılan Kol / For	t mm	Adaptör vidası	g	TL/Ad.
7120 29 2540	25 - 40	35 - 75 60 - 130	45	M10	235	282,03
7120 29 4075	40 - 75	60 - 210	100	G3/8	1200	449,26
7120 29 7011	70 - 115	60 - 210	130	G3/8	1400	635,59

7120

İç Rulman Çektirme Kolları Arms For Internal Expansion Puller



Krom vanadyum, Çinko kaplı, Kollar sertleştirilmiş,
Mil indüksiyonda sertleştirilmiş
Chrom vanadium, Zinc plated,
Arms hardened, Spindle induction hardened

KOD CODE	Kapasite Capacity mm	Kullanılan pensler / For	Adaptör vidası	g	TL/Ad.
7120 29 3575	35 - 75	Model A 5 - 7'den 43 - 50'ye Model B 25 - 40	M10	625	141,85
7120 29 6013	60 - 130	Model A 30 - 37'den 43 - 50'ye Model B 25 - 40	M10	1000	287,56
7120 29 6021	60 - 210	Model A 40 - 55'den 50 - 60'a Model B 40 - 70'den 70 - 115'e	G3/8	1000	673,38

7122

Dış Rulman Çektirme Çeneleri Seperator



Krom vanadyum, Çinko kaplı, Kollar sertleştirilmiş,
Mil indüksiyonda sertleştirilmiş
Chrom vanadium, Zinc plated,
Arms hardened, Spindle induction hardened

KOD CODE	Ø mm	Kullanılan Kollar / For	Adaptör vidası	g	TL/Ad.
7122 29 0560	5 - 60	40 - 115	M12	370	199,99
7122 29 1275	12 - 75	40 - 115	M12	635	239,69
7122 29 2211	22 - 115	55 - 205	M16x1.5	1780	374,29
7122 29 2515	25 - 155	90 - 260	M20x1.5	3940	586,00
7122 29 3022	30 - 220	100 - 360	M20x1.5	11000	1601,72
7122 29 4028	40 - 280	140 - 435	M24x1.5	15000	2862,05

7122

Dış Rulman Çektirme Kolları Puller Arms For Seperator

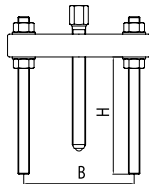

Krom vanadyum, Çinko kaplı, Kollar sertleştirilmiş,
Mil indüksiyonda sertleştirilmiş
Chrom vanadium, Zinc plated,
Arms hardened, Spindle induction hardened

KOD CODE	B mm	Kullanılan Çene / For	H mm	Adaptör vidası	g	TL/Ad.
7122 29 4011	40-115	5 - 60 12 - 75	150	M12	990	285,29
7122 29 5520	55-205	22 - 115	210	M16x1.5	2700	451,64
7122 29 9026	90-260	25 - 155	315	M20x1.5	4965	639,46
7122 29 1036	100-360	30 - 220	305	M20x1.5	7000	1316,15
7122 29 1443	140-435	40 - 280	320	M24x1.5	11000	2057,99

7124

Amortisör Çektirme Puller For Shock Absorber

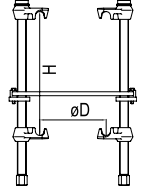

KOD CODE	KAPASİTE CAPACITY	øD mm	øD mm	H mm	g	TL/Ad.
7124 29 1118	110x180/240	110	180	240	2445	455,71

7125

Rotil Çektirme (Çatal) Ball Joint Seperator

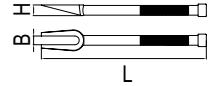

KOD CODE	B mm	H mm	L mm	g	TL/Ad.
7125 29 0018	18	22	330	785	193,91
7125 29 0023	23	22	330	865	202,71
7125 29 0031	31	26	330	1060	275,83
7125 29 0035	35	26	350	1150	278,97
7125 29 0045	45	26	350	1155	357,28

7126

Rotil Çektirme Extractor For Ball Joint

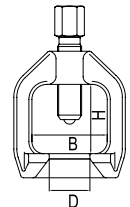

KOD CODE	øD mm	B mm	H mm	g	TL/Ad.
7126 29 0018	18	40	40	315	119,05
7126 29 0025	25	50	50	540	163,26
7126 29 0029	29	60	60	915	209,17
7126 29 0040	40	80	80	1965	284,82
7126 29 0045	45	90	100	2670	335,64

7128

Rotil Çektirme
Extractor For Ball Joint



KOD CODE	KAPASİTE CAPACITY mm	g	TL/Ad.
7128 29 1822	18 - 22	830	1 234,56

7130

Saplama Sökme - Model A
Stud inserter And Remover Cam Type - Model A

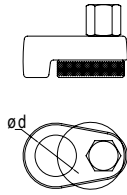

KOD CODE	KAPASİTE CAPACITY mm	øD mm	g	TL/Ad.
7130 29 0515	5 - 15	15	350	1 192,62
7130 29 1019	10 - 19	19	365	1 207,77
7130 29 1828	18 - 28	28	410	1 238,51

7131

Saplama Sökme - Model B
Stud Inserter And Remover Cam Type - Model B

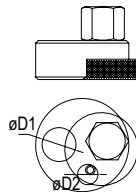

KOD CODE	KAPASİTE CAPACITY mm	øD1 mm	øD2 mm	g	TL/Ad.
7131 29 0520	5 - 20	22	12	410	1 190,09



Takım antaları Atölye Dolapları ve Alet Setleri

9

*Teřhir Sehpaları
Panolar
Tamir Dolapları
Takım antaları
Servis Masaları
Alet Setleri*

*Displays
Panels
Tool Cabinets
Tool Boxes
Service Tables
Tool Sets*



Pro Serisi Takım Dolabı (5-6-7-8 Çekmeceli)
Pro Series Workshop Trolley (5-6-7-8 Drawers)

Ölçü/Size 470x670x970mm
Sacdan imal edilmiş, Fırın boyu
Made from metal sheet, Electrostatic paint

- ✓ Merkezi kilit ve çekmeceler için ayrıca Açma mekanizması.
- Central locking and a separate opening mechanism for drawers

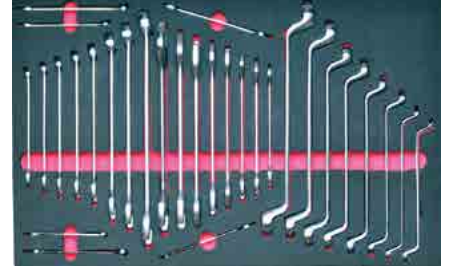

- ✓ Rulmanlı yüksek kaliteli kızaklar. Tüm çekmeceler %100 açılabilir.
- Ball bearing high quality slides All drawers %100 extendable.

- ✓ 8 bölmeli sağlam ve dayanıklı ABS plastik üst malzeme tabla.
- Resistant and solid top cover having 8 divisions



- ✓ 2 sabit, 2 hareketli frenli tekerlek Ø 125mm
- 2 swivel castors with stop fix brake 2 fixed castors Ø 125mm

- ✓ 1mm gövde sac kalınlığı ile yüksek dayanımlı elektrostatik toz boya.
- High strength electrostatic powder coating



- ✓ Toplam 6 Adet yan ve arka avadanlık bölümleri.
- Totaly 6 tool holders

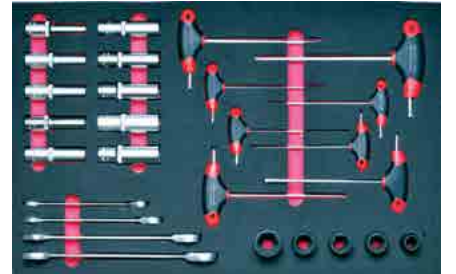

KOD/CODE	CEKMECE DRAWERS				kg	RENK COLORS	FİYAT TL/Ad
		400X548X68	400X548X143	400X548X218			
8241 32 1005	5	1X	4X	--	59		1482,25
8241 32 1006	6	4X	1X	1X	62	RAL 7035	1778,70
8241 32 1007	7	5X	2X	--	65	RAL 3020	2075,15
8241 32 1008	8	7X	1X	--	67		2378,38
8241 32 2005	5	1X	4X	--	59		1482,25
8241 32 2006	6	4X	1X	1X	62	RAL 7035	1778,70
8241 32 2007	7	5X	2X	--	65	RAL 5003	2075,15
8241 32 2008	8	7X	1X	--	67		2378,38
8241 32 3005	5	1X	4X	--	59		1482,25
8241 32 3006	6	4X	1X	1X	62	RAL 7035	1778,70
8241 32 3007	7	5X	2X	--	65	RAL 7016	2075,15
8241 32 3008	8	7X	1X	--	67		2378,38
8241 00 1209 Dolu/Full 209 Parça/Pcs	8	7x	1x	--		RAL 7035 RAL 3020	6399,64

1. Çekmece/Drawer

KOD CODE	İÇERİK CONTENTS	
0130	0130 İki ağız anahtar/D/E Open Jaw Wrench 6x7 - 8x9 - 10x11 - 12x13 14x15 - 16x17 - 18x19 - 20x22 21x23 - 24x26	10
0330	0330 Kombine Anahtar/Combination Wrench 6 - 7 - 8 - 9 - 10 - 11 - 12 - 13 14 - 17 - 19 - 22	12
0430	0430 Yıldız Anahtar /D/E Ring Wrench 6x7 - 8x9 - 10x11 - 12x13 14x15 - 16x17 18x19 - 20x22	8

2. Çekmece/Drawer

KOD CODE	LOKMALAR Sockets	AVADANLIKLAR Accessories	
		1/4" Karbüratör Lokma Takımı / 1/4" Socket Wrench Set	
		1/4" Cırcır kolu/ 1/4" Ratchet Handle	
	4 - 5 - 6 7 - 8 - 9 - 10 11 - 12 - 13	1/4" Mafsal/1/4" Universal Joint	
	Altı Köşe Six Point	1/4" T Kol / 1/4" Sliding T Handle	
1107	8 - 10 Sekiz Köşe Eight Points	1/4" Ara Kol / 1/4" Extension Bar 54 mm	18
		1/4" Ara Kol/1/4" Extension Bar 100 mm	
		1/4" Mafsalı Kol/1/4" Flexible Handle	

KOD CODE	LOKMALAR Sockets	AVADANLIKLAR Accessories	
		1/2" Lokma Takımı/1/2" Socket Wrench Set	
		1/2" Cırcır Kolu /1/2" Ratchet Handle	
	10 - 11 - 12 13 - 14 - 15 16 - 17 - 18 19 - 21 - 22 23 - 24 - 26 27 - 28 - 30 32	1/2" Mafsal/1/2" Universal Joint	
1113		1/2" T Kol1/2" /Sliding T Handle	24
		1/2" Ara Kol/ 125 mm	
		1/2" Ara Kol/1/2" Extension Bar 250 mm	

KOD CODE	İÇERİK CONTENTS	
1113	1/2" Lokmalı Allen Uçlar/1/2" Hexagonal Bits Sockets H5-H6-H7-H8 H10-H12-H14	7
1113	1/2" Lokmalı Star Uç/1/2" Star Bits Socket T20-T25-T27-T30-T40 T45-T50-T55-T60	9
0330	Kombine Anahtar Uzun Boy Combination Wrench Long 16-18mm	2
4900	Allen Takımı 6 Köşe Hex Key Wrench Set 2-2.5-3-3.5-4-5 6-7-8-9-10-12	12

3. Çekmece/Drawer

KOD CODE	İÇERİK CONTENTS	
07415	Sıralı Tel Fırça 3 Sıralı/Hand Brush 3 Raws	1
6350	Levye Oluklu /Tyre Lever 400mm	1
6220	Spiralli Miknats /Flexible Magnet Holder 500gr	1
4310	Düz Topaç Tornavida /Screwdriver Kraft,Stubby,Flat 6,5x25	1
4330	Yıldız Topaç Tornavida Screwdriver Kraft,Stubby,Phillips 6x25	1
4770	Lokma Uçlu Tornavida/Nutspinner 6-7-8-9-10-13	6
4780	Manyetik Bits Tutucu Tornavida Screwdriver,Magnetic Bit Holder 6,3x120	1
4905	Yuvarlak Başlı Allen Takımı (Kutulu) Hexkey Wrench Ballpoint set	8
4800	Bits Set Takım (Kutulu)/Bit Set in metal case	31

4. Çekmece/Drawer

KOD CODE	İÇERİK CONTENTS	
0340	Cırcır Kombine Anahtar /Combination Wrenchwith Ratchet 10-13-17-19mm	4
4909	T Tipi Torx Allen Anahtar/Torx Allen Key T tape T9-T10-T15-T20-T25-T27-T30-T40	8
1108	1/2" Altı Köşe Derin Lokma/1/2" Deep Socket Wrench, six points 10-11-12-13-14-15-16-17-18-19	10
1113	1/2" Altı Köşe Havalı Lokma/1/2" Impact Socket Wrench 13-17-18-19-24mm	5

5. Çekmece/Drawer

KOD CODE	İÇERİK CONTENTS	
3331	İç eğri segman pense/Circlip Plier,Internal,Bent 170mm	1
3321	İç Düz segman pense /Circlip Plier,Internal,Flat 180mm	1
3311	Dış Eğri segman pense/Circlip Plier,External,Bent 170mm	1
3301	Dış Düz segman pense/Circlip Plier,External,Flat 180mm	1
3700	Yan Keski Rod İzole/Side Cutting Nipper, Rod 160mm	1
3220	Düz Kargaburun Rod İzole/Long Nose Plier,Rod 200mm	1
3020	Kombine Pense Rod İzole/Combination Plier Rod 180mm	1
2510	Special Ayarlı Pense (Krom)/Special Grip	1
0600	Kurbağacık Anahtar/Adjustable Jaw Wrench 10"	1
2400	Üniversal Fort Pense/Universal Grip 240mm	1

6. Çekmece/Drawer

KOD CODE	İÇERİK CONTENTS	
4300	Rod Seri Düz Uçlu Tornavida/Rod Screwdriver,Flat 4x100-5x125-6x150-8x175	4
4320	Rod Seri Yıldız Uçlu Tornavida/Rod Screwdriver,Phillips 4.5x80-6x100	2
5800	Tesviyeci Çekiç/Mechanist's Hammer 300gr	1
5850	Plastik Çekiç /Plastic Hammer ø30	1
5545	Konik Pim Zimba /Split Pin Punch 5mm	1
5550	Düz Pim Zimba/Split Pin Punch 5mm	1
5540	Nokta Zimba/Center Punch 5x120	1
5500	Düz Keski/Flat Cold Chisel 150mm	1
4920	T Tipi Allen Anahtar/T Type Hex Key Wrench 3-4-5-6-7-8	6

İzeltas Partner Mobil Takım Dolabı (5 Çekmeceli) İzeltas Partner Workshop Trolley (5 Drawers)



Ölçü/Size: 470x670x940mm

Sacdan imal edilmiş, Fırın boyalı
Made from metal sheet, Electrostatic paint



- ✓ Merkezi kilit.
- Central locking.



- ✓ Rulmanlı, yüksek kaliteli kızaklar. Tüm çekmeceler %100 açılabilir.
- Ball bearing high quality slides All drawers %100 extendable



- ✓ 8 Bölmeli, sağlam ABS tabla
- 8 Durable ABS worktop with divisions







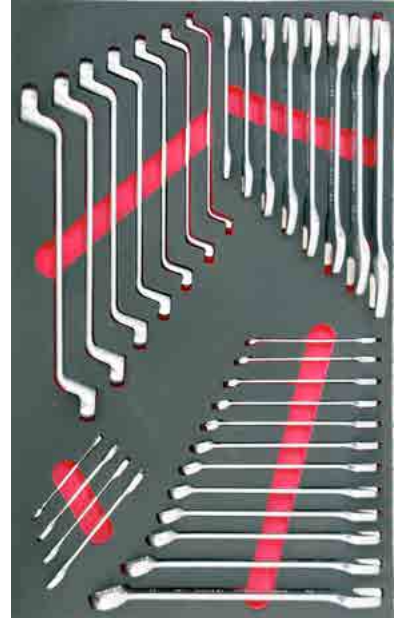

- ✓ 2 sabit, 2 hareketli frenli tekerlek ø 125mm
- 2 swivel castors with stop fix brake
2 fixed castors ø 125mm



- ✓ Yüksek dayanımlı elektrotatik toz boya.
- High strength electrostatic powder coating



KOD/CODE	ÇEKMECE DRAWERS			 kg	RENK COLORS	FİYAT TL/Ad
		350x550x75	400x550x180			
8235 32 6005	5	3X	2X	56		1427,03
8235 32 7005	5	3X	2X	56		1427,03
8235 32 5005	5	3X	2X	56		1427,03
8235 00 6121 Dolu/Full 121 Parça/Pcs	5	3X	2X			3744,57

1. Çekmece/Drawer

KOD CODE	LOKMALAR Sockets	AVADANLIKLAR Accessories	
1107	4 - 5 - 6 7 - 8 - 9 - 10 11 - 12 - 13 Altı Köşe Six Points 8 - 10 Sekiz Köşe Eight Points	1/4" Karbüratör Lokma Takımı 1/4" Socket Wrench Set	18
		1/4" Cırcır kolu Ratchet Handle	
		1/4" Mafsal Universal Joint	
		1/4" T Kol Sliding T Handle	
		1/4" Ara Kol Extention Bar 50 mm	
1113	10 - 11 - 12 13 14 - 15 16 - 17 - 18 19 - 21 - 22 23 - 24 - 26 27 28 - 30 32	1/2" Lokma Takımı 1/2" Socket Set	24
		1/2" Cırcır Kolu / Ratchet Handle	
		1/2" Mafsal Universal Joint	
		1/2" T Kol Sliding T Handle	
		1/2" Ara Kol Extention Bar 125 mm	
		1/2" Ara Kol Extention Bar 250 mm	
KOD CODE	LOKMALAR Sockets	AVADANLIKLAR Accessories	
KOD CODE	İÇERİK CONTENTS		
1507	1/4" Derin Lokma Tornavida Adaptörü Spindle Handle		1
4900	12 'li Allen Anahtar Takımı Hex Key Wrench Set 2-2.5-3-3.5-4-5-6-7-8-9-10-12mm		12
4910	8 'li Torx Allen Anahtar Takımı Torx Key Wrench 6 Point		8
1108	1/2" Altı Köşe Derin Lokma Deep Socket Wrench 6 Point 10-13-16-17-18-19mm		6
1113	1/2" 16 mm Buji Lokma Anahtar Spark Plug Socket With Rubber		1
2400	240 mm Üniversal Fort Pense Waterpump Pliers, Universal		1
2500	250 mm Üniversal Ayarlı Pense Waterpump Pliers, Universal		1

2. Çekmece/Drawer

KOD CODE	İÇERİK CONTENTS		
0100	0100 İki ağız anahtar Double Ended Open Jaw Wrench 6x7 - 8x9 - 10x11 - 12x13 14x15 - 16x17 - 18x19 - 20x22 21x23 - 24x26 - 25x28 - 30x32		12
0320	0320 Kombine Anahtar Combination wrenches 8 - 9 - 10 - 11 - 12 - 13 14 - 15 - 16 - 17 - 19 - 22		12
0430	0430 Yıldız Anahtar Ring Wrenches 8x9 - 10x11 - 12x13 14x15 - 16x17 18x19 - 20x22		7

3. Çekmece/Drawer

KOD CODE	İÇERİK CONTENTS		
4300	Rod Seri Düz Uçlu Tornavida Screwdriver, Rod Flat 3x80-4x80-4X100-5x125-6x150		5
4320	Rod Seri Yıldız Uçlu Tornavida Screwdriver, Rod Philips 4.5x80-6x100		2
3700	Yan Keski Opak Side Cutting Pliers 160mm		1
3020	Kombine Pense Opak Combination Pliers 180mm		1
3220	Düz Kargaburun Opak Long Nose Pliers Flat 200mm		1
4770	Lokma Uçlu Tornavida Nut Spinner 6-7-8-10-13		5
5500	Düz Keski Flat Cold Chisel 150mm		1
5800	Çekiç Machinist's Hammer 500 gr.		1

Garaj Serisi Takım Dolabı (5-6-7-8 Çekmeceli) Garage Series Workshop Trolley (5-6-7-8 Drawers)



Ölçü/Size: 470x670x970mm

Sacdan imal edilmiş, Fırın boyu
Made from metal sheet, Electrostatic paint



- ✓ Ergonomik sap
- Ergonomic handle



- ✓ 8 Bölmeli, sağlam ABS tabla
- Durable ABS worktop with divisions

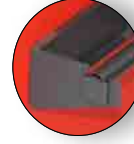

- ✓ Havluluk x1 Avadanlık x2 Askılık x1
- Paper Roll Holder x1 Bottle & Tins Holder x2 Hanger x1



- ✓ Rulmanlı, yüksek kaliteli kazaklar. Tüm çekmeceler %100 açılabilir.
- Ball bearing high quality slides All drawers %100 extendable.



- ✓ Merkezi kilit, tek kilitlenebilir çekmece.
- Central locking, single locked drawers, roll over safety locking system





- ✓ 2 sabit, 2 hareketli frenli tekerlek Ø 125mm
- 2 swivel castors with stop fix brake 2 fixed castors Ø 125mm



- ✓ Yüksek dayanımlı elektrozstatik toz boya.
- High strength electrostatic powder coating



KOD/CODE	ÇEKMECE DRAWERS				kg	RENK COLORS	FİYAT TL/Ad
		400X548X68	400X548X143	400X548X218			
8242 32 1005	5	1X	4X	--	59		1603,25
8242 32 1006	6	4X	1X	1X	62	RAL 7035	1923,90
8242 32 1007	7	5X	2X	--	65	RAL 3020	2246,65
8242 32 1008	8	7X	1X	--	67		2565,20
8242 32 2005	5	1X	4X	--	59		1603,25
8242 32 2006	6	4X	1X	1X	62	RAL 7035	1923,90
8242 32 2007	7	5X	2X	--	65	RAL 5003	2246,65
8242 32 2008	8	7X	1X	--	67		2565,20
8242 32 3005	5	1X	4X	--	59		1603,25
8242 32 3006	6	4X	1X	1X	62	RAL 7035	1923,90
8242 32 3007	7	5X	2X	--	65	RAL 7016	2246,65
8242 32 3008	8	7X	1X	--	67		2565,20
8242 00 1142 Dolu/Full 142 Parça/Pcs	7	5x	2x	--			5307,60

1. Çekmece/Drawer

KOD CODE	İÇERİK CONTENTS	
0130	0130 İki ağız anahtar/ D/E Open jaw wrenches 6x7 - 8x9 - 10x11 - 12x13 14x15 - 16x17 - 18x19 - 20x22 - 21x23 - 24x26	10
0330	0330 Kombine Anahtar/Combination wrenches 6 - 7 - 8 - 9 - 10 - 11 - 12 - 13 - 14 - 17 - 19 - 22	12
0430	0430 Yıldız Anahtar / Ring Wrenches 6x7 - 8x9 - 10x11 - 12x13 - 14x15 - 16x17 18x19 - 20x22	8

2. Çekmece/Drawer

KOD CODE	İÇERİK CONTENTS	
4900	Allen Takımı 6 Köşe/Hex Key Wrench Set 2-2.5-3-3.5-4-5-6-7-8-9-10-12	12

KOD CODE	LOKMALAR Sockets	AVADANLIKLAR Accessories	
1107	4 - 5 - 6 7 - 8 - 9 - 10 11 - 12 - 13 Altı Köşe Six Points	1/4" Karbüratör Lokma Takımı 1/4" Cırcır kolu Ratchet Handle	18
		1/4" Mafsalsal Universal Joint	
		1/4" T Kol/Sliding T Handle	
		1/4" Ara Kol /Extension Bar 54 mm	
		1/4" Ara Kol Extension Bar 100 mm	
1107	8 - 10 Sekiz Köşe Eight Points	1/4" Mafsalsal Kol Flexible Handle	18

KOD CODE	LOKMALAR Sockets	AVADANLIKLAR Accessories	
1113	10 - 11 - 12 13 - 14 - 15 16 - 17 - 18 19 - 21 - 22 23 - 24 - 26 27 - 28 - 30 32	1/2" Lokma Takımı 1/2" Cırcır Kolu Ratchet Handle	24
		1/2 U Kol / Speed Brace with Revolving Rubber Handle	
		1/2" Mafsalsal Universal Joint	
		1/2" T Kol Sliding T Handle	
		1/2" Ara Kol Extension Bar 125 mm	
1113		1/2" Ara Kol Extension Bar 250 mm	24

KOD CODE	İÇERİK CONTENTS	
1113	1/2" Lokmalı Allen Uçlar H5-H6-H7-H8-H10-H12-H14	7

KOD CODE	İÇERİK CONTENTS	
1113	1/2" Lokmalı Star Uç /1/2 Star Bits Socket T20-T25-T27-T30-T40-T45-T50-T55-T60	9

KOD CODE	İÇERİK CONTENTS	
0330	Kombine Anahtar Uzun Boy 16-18mm Combination Pliers Long 16-18mm	2

3. Çekmece/Drawer

KOD CODE	İÇERİK CONTENTS	
3331	İç eğri segman pense Circlip Pliers Internal (Bent) 170mm	1
3321	İç Düz segman pense Circlip Pliers Internal (Flat) 180mm	1
3311	Dış Eğri segman pense Circlip Pliers External (Bent) 170mm	1
3301	Dış Düz segman pense Circlip Pliers External (Flat) 180mm	1
3700	Yan Keski Rod İzole Side Cutting Pliers 160mm	1
3220	Düz Kargaburun Rod İzole Long Nose Pliers(Flat) 200mm	1
3020	Kombine Pense Rod İzole Combination Pliers 180mm	1
2510	Special Ayarlı Pense Waterpump Pliers Special 250mm	1
0600	Kurbağacık Anahtar Adjustable Wrench 10"	1
2400	Üniversal Fort Pense Universal Grip 240mm	1

4. Çekmece/Drawer

KOD CODE	İÇERİK CONTENTS	
4300	Rod Seri Düz Uçlu Tornavida Screwdriver, Rod Flat 5x125-4x100-6x150-8x175	4
4320	Rod Seri Yıldız Uçlu Tornavida Screwdriver, Rod Philips 4.5x80-6x100	2
5800	Tesviyeci Çekiç Machinist's Hammer 300gr	1
5850	Plastik Çekiç Plastic Hammer ø30	1
5545	Konik Pim Zimba Drift Punch 5mm	1
5550	Düz Pim Zimba Split Pin Punch 5mm	1
5540	Nokta Zimba Center Punch 5x120	1
5500	Düz Keski Flat Cold Chisel 150mm	1
4920	T Tipi Allen Anahtar Hex Key Wrench T3-4-5-6-7-8	6

5. Çekmece/Drawer

KOD CODE	İÇERİK CONTENTS	
07415	Sıralı Tel Fırça 3 Sıralı Hand Brush 3 Raws	1
6350	Levye Oluklu Tyre Lever, Straight 400mm	1
6220	Spiralli Mıknatıs Flexible Magnet Holder 500gr	1
4310	Düz Topaç Tornavida Screwdriver Stubby Flat 6,5x25	1
4330	Yıldız Topaç Tornavida Screwdriver Stubby Phillips 6x25	1
4770	Lokma Uçlu Tornavida Nut Spinner 6-7-8-9-10-13	6

Eko Serisi Takım Dolabı (5-7 Çekmeceli)
Eco Series Workshop Trolley (5-7 Drawers)



Ölçü/Size: 405x613x880mm Sacdan imal edilmiş, Fırın boya
Made from metal sheet, Electrostatic pain



✓ 4 bölmeli sağlam ve dayanıklı ABS plastik üst malzeme tabla.
 ● Resistant and solid top cover having 4 divisions



✓ Rulmanlı, yüksek kaliteli kızaklar. Tüm çekmeceler %100 açılabilir.
 ● Ball bearing high quality slides All drawers %100 extendable



✓ Merkezi kilit
 ● Central locking



✓ 2 sabit, 2 hareketli frenli tekerlek ø 100mm
 ● 2 swivel castors with stop fix brake 2 fixed castors ø 100mm



✓ Yüksek dayanımlı elektrostatik toz boya.
 ● High strength electrostatic powder coating.

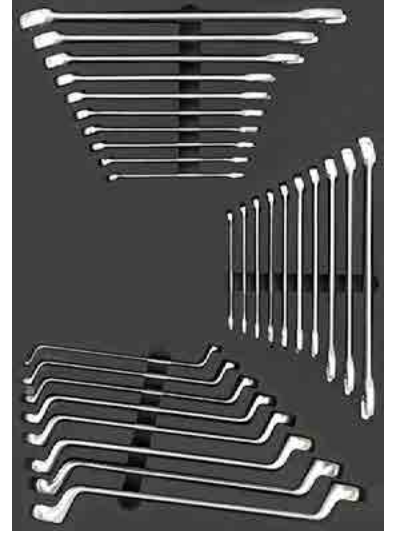

KOD/CODE	ÇEKMECE DRAWERS				RENK COLORS	FİYAT TL/Ad
		350x550x75	400x550x180			
8243 32 1005	5	3X	2X	64	RAL 7035 RAL 3020	1161,60
8243 32 1007	7	7X	--			1300,75
8243 32 2005	5	3X	2X	64	RAL 7035 RAL 5003	1161,60
8243 32 2007	7	7X	--			1300,75
8243 32 3005	5	3X	2X	64	RAL 7035 RAL 7016	1161,60
8243 32 3007	7	7X	--			1300,75
8243 00 1096 Dolu/Full 96 Parça/Pcs	5	3X	2X			2885,85

1.Çekmece/Drawer

İÇERİK CONTENTS	☐	TL/Ad.
0100 İki ağız anahtar D/E Open jaw wrenches 6x7 - 8x9 - 10x11 - 12x13 14x15 - 16x17 - 18x19 - 20x22 - 21x23 - 24x26	10	
0320 Kombine Anahtar Combination wrenches 8 - 9 - 10 - 11 - 12 - 13 - 14 - 15 - 16 - 17 - 19 - 22	12	
0430 Yıldız Anahtar Ring Wrenches 6x7 - 8x9 - 10x11 - 12x13 - 14x15 - 16x17 18x19 - 20x22	8	

2.Çekmece/Drawer

İÇERİK CONTENTS	☐	TL/Ad.
1113 1/2" 17'li Lokma Takımı Socket Wrench Set 1/2" mm 10 - 11 - 12 - 13 - 15 - 17 - 19 22 - 24 - 27 - 30 - 32 250 - 250 - 250 - 70	17	
Karbüratör Lokma Takımı Socket Wrench Set 1/4"mm 4 - 5 - 6 - 7 - 8 - 9 - 10 - 11 - 12 - 13 Sekiz köşe / Eight points 8 - 10 140 - 115 - 100 - 50 - 38 - 130	18	
4900 Allen Anahtar Takımı Hex Key Wrench Set 2 - 2.5 - 3 - 3.5 - 4 - 5 - 6 - 7 - 8 - 9 - 10 - 12	12	
Lokma Uçlu Tornavidalar Nutspinners 6 - 7 - 8 - 10 - 13	5	

3.Çekmece/Drawer

İÇERİK CONTENTS	☐	TL/Ad.
4320 Rod Yıldız Uçlu Tornavida Rod Screwdriver,Phillips 4,5x80-6x100mm	2	
4300 Rod Düz Uçlu Tornavida Rod Screwdriver,Flat 5x125-4x100-6x150-7x175mm	4	
3700 Yan Keski Opak Side Cutting Pliers 160mm	1	
3020 Kombine Pense Opak Combination Pliers 180mm	1	
3220 Uzun Kargaburun Düz Uçlu Opak Long Nose Pliers, Flat 160mm	1	
5500 Düz Keski Krom Flat Cold Chisel 150mm	1	
5800 Tesviyeci Çekici Machinist's Hammer 300gr	1	
2510 Special Ayarlı Pense Waterpump Pliers Special 250mm	1	
2400 Ünsersal Fort Pense PVC Universal Grip 240mm	1	



Vagon Serisi
Wagon Series



- ✓ 8 Bölmeli, sağlam ABS tabla
- Durable ABS worktop with divisions



- ✓ Kilit T kol
- Locked T-handle



- ✓ 2 Sabit, 2 hareketli frenli tekerlek ø 125mm
- 2 swivel castors with stop fix brake 2 fixed castors ø 125mm

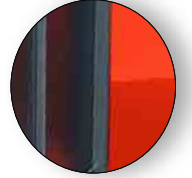

- ✓ Yüksek dayanımlı elektrostatik toz boya.
- High strength electrostatic powder coating

Ölçü/Size: 470x670x970mm

Sacdan imal edilmiş, Fırın boya
Made from metal sheet, Electrostatic pain



KOD/CODE	SIZE (mm)	KG	RENK COLORS	FİYAT TL/AD
8210 32 6001	470x670x970	45		948,97

8160 TAKIM DOLABI SERİSİ / TOOL CABINET SERIES

Takım Dolabı Serisi
Workshop Trolley Series



- ✓ Rulmanlı yüksek kaliteli kızak.
- High strength electrostatic powder coating



- ✓ Kilit T kol
- Ball bearing high quality slides

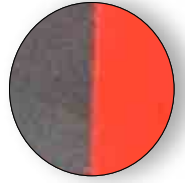



- ✓ Yüksek dayanımlı elektrostatik toz boya.
- High strength electrostatic powder coating

Ölçü/Size: 250x650x1010mm

Sacdan imal edilmiş, Fırın boya
Made from metal sheet, Electrostatic pain

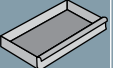

KOD/CODE		SIZE (mm)	 KG	COLORS	FİYAT TL/Ad.
	200x500x55				
8160 32 6001	3x	250x650x1010	35		691,35

Çekmeceli Takım Sandığı
Tool Cabinet With Drawers

KOD CODE	ÖLÇÜ SIZE mm	g	TL/Ad.
8310 33 6001	280x650x300	23600	1 597,89
8310 00 6073	DOLU / FULL		1 -----

KOD CODE	İÇERİK CONTENTS	TL/Ad.
0130 00 2108	6x7 - 8x9 - 10x11 - 12x13 - 14x15 - 16x17 - 18x19 - 20x22	8
0330 00 2108	6 - 7 - 8 - 9 - 10 - 13 - 17 - 19	8
0430 00 2108	6x7 - 8x9 - 10x11 - 12x13 - 14x15 - 16x17 - 18x19 - 20x22	8
1113 00 6018	10 - 11 - 12 - 13 - 14 - 15 - 17 - 19 - 22 - 24 - 27 - 30 - 32 - 275 - 400 - 250 - 250 - 70	18
0600 01 1010	10*(250 mm)	1
2400 11 0240	240 mm	1
2500 11 0250	250 mm	1
3020 12 3180	180 mm	1
3220 13 3160	160mm	1
3220 13 3200	200 mm	1
3225 13 3200	200 mm	1
3700 16 3160	160 mm	1
4100 17 4100	4x100	
4100 17 5125	5x125	3
4100 17 6150	6x150	
4120 18 0360	3x60	
4120 18 4580	4.5x80	3
4120 18 6100	6x100	
4900 00 3110	2 - 2.5 - 3 - 4 - 5 - 6 - 7 - 8 - 9 - 10	10
5500 23 0150	150 mm	1
5520 23 0125	125 mm	1
5540 24 4120	4x120	1
5550 24 0006	ø 6	1
5800 25 0300	300 gr	1
5850 25 0030	ø 30	1



8410

Takım Çantası (3 Gözlü) Tool Box (3 Trays)



Sacdan imal edilmiş, Fırın boya
Made from metal sheet, Electrostatic paint



KOD CODE	ÖLÇÜ SIZE mm	g	TL/Ad.
8410 33 6103	190x300x150	2400	1 76,14
8410 33 6203	190x420x150	3000	1 84,78
8410 00 6036	DOLU / FULL		1 -----

KOD CODE	İÇERİK CONTENTS	TL/Ad.
0130 00 2108	6x7 - 8x9 - 10x11 12x13 - 14x15 - 16x17 18x19 - 20x22	8
0430 00 2108	6x7 - 8x9 - 10x11 12x13 - 14x15 - 16x17 18x19 - 20x22	8
1841 07 0021	21 mm	1
2400 11 0240	240 mm	1
3020 12 3180	180 mm	1
3700 16 3160	160 mm	1
4100 17 5100	5x100	1
4120 18 4580	4.5x80	1
4900 00 3110	2 - 2.5 - 3 - 4 - 5 6 - 7 - 8 - 9 - 10	10
5500 23 0150	150 mm	1
5540 24 4120	4x120	1
3800 15 0180	180 mm	1
5800 25 0030	300 gr	1

8420

Takım Çantası (5 Gözlü) Tool Box (5 Trays)

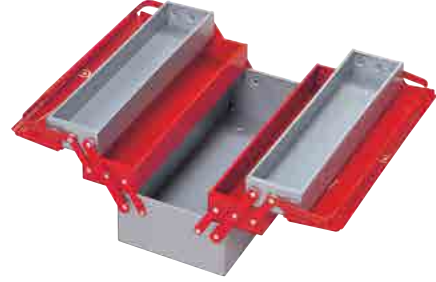

Sacdan imal edilmiş, Fırın boya
Made from metal sheet, Electrostatic paint



KOD CODE	ÖLÇÜ SIZE mm	g	TL/Ad.
8420 33 6105	190x300x200	3200	1 93,08
8420 33 6205	190x420x200	4200	1 102,58
8420 33 6305	190x520x200	5000	1 118,40
8420 33 6405	190x600x200	5600	1 -----
8420 00 6061	DOLU / FULL		1 -----

KOD CODE	İÇERİK CONTENTS	TL/Ad.
0130 00 2108	6x7 - 8x9 - 10x11 - 12x13 - 14x15 - 16x17 18x19 - 20x22	8
0430 00 2108	6x7 - 8x9 - 10x11 - 12x13 - 14x15 - 16x17 18x19 - 20x22	8
1113 00 6018	10 - 11 - 12 - 13 - 14 - 15 - 17 - 19 - 22 - 24 - 27 - 30 - 32 - 275 - 400 - 250 - 250 - 70	18
0600 01 1010	10*(250 mm)	1
2400 11 0240	240 mm	1
2500 11 0250	250 mm	1
3020 12 3180	180 mm	1
3220 13 3200	200 mm	1
3700 16 3160	160 mm	1
4100 17 0380	3x80	
4100 17 4100	4x100	3
4100 17 5125	5x125	
4110 17 6525	6.5x25	1
4120 18 0360	3x60	
4120 18 4580	4.5x80	2
4900 00 3110	2 - 2.5 - 3 - 4 - 5 - 6 - 7 - 8 - 9 - 10	10
5540 24 4120	4x120	1
5500 23 0150	150 mm	1
5800 25 0300	300 gr	1
5850 25 0030	ø 30	1
6350 26 0300	300 mm	1

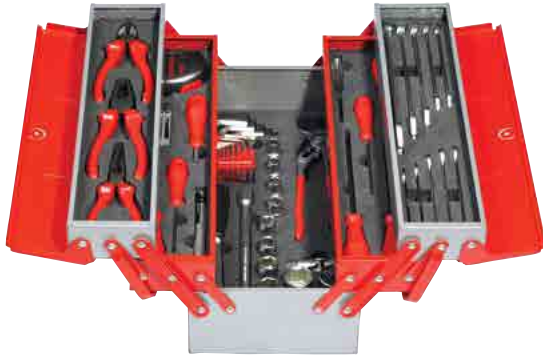
Mekanik Takım Çantası (5 Gözlü)
Tool Box (5 Trays)

Sacdan imal edilmiş, Fırın boya
 Made from metal sheet, Electrostatic paint

KOD CODE	ÖLÇÜ SIZE mm	g	TL/Ad.
8420 00 5063	190x420x200 DOLU / FULL	63	1109,54



KOD CODE	İÇERİK CONTENTS	TL/Ad.
05881 50 015	5 m KROM ŞERİT METRE/Chrom Case Steel, Measuring tapes	1
4785 19 6330	KISA BİTS TUTUCU/Screwdriver, Magnetic Bit Polder (Short) 6,3x30	1
4800 00 8110	10 'LU BİTS TAKIM/ Bits Set 10 (Pcs) 25 mm	1
05870 50 001	LED FENER /Digital Laser Meter	1
4320	ROD YILDIZ TORNAVİDA Screwdriver, Rod, Flat 4,5x80-6x100	2
4300	ROD DÜZ TORNAVİDA Screwdriver, Rod, Philips 3x80-4x100-5x125-6x150	4
4550 17 0135	135 KONTROL KALEMİ / Voltage Tester	1
2400 11 0240	240 ÜNİVERSAL FORT PENSE Water pump Pliers Universal	1
1113	1/2" LOKMA ANAHTAR / Socket Wrench 10-11-12-13-14-15-17-19-22-24-27-30-32mm	13
1513 06 4250	1/2" UZUN ARA KOL/Extension Bar Long 250mm	1
1513 06 4070	1/2" MAFSAL/Universal Joint 70 mm	1
1512 06 0032	1/2" CIRCIR KOLU 32 DİŞ/ Ratchet Handle 250 mm	1
4900 00 3112	12 'Lİ ALLEN TAKIM/Hax Key Wrench Set	1
0320	KISA KOMBİNE ANAHTAR/ Combination Wrench Short Pattern 8-9-10-11-12-13-14-17-19-22 mm	10
3700 16 2160	160mm OPAK YAN KESKİ/Side Cutting Pliers	1
3020 12 2180	180mm OPAK KOMBİNE PENSE/Combination Pliers	1
3220 13 2160	160mm OPAK UZUN DÜZ KARGABURUN/Long Nose Pliers (Flat)	1

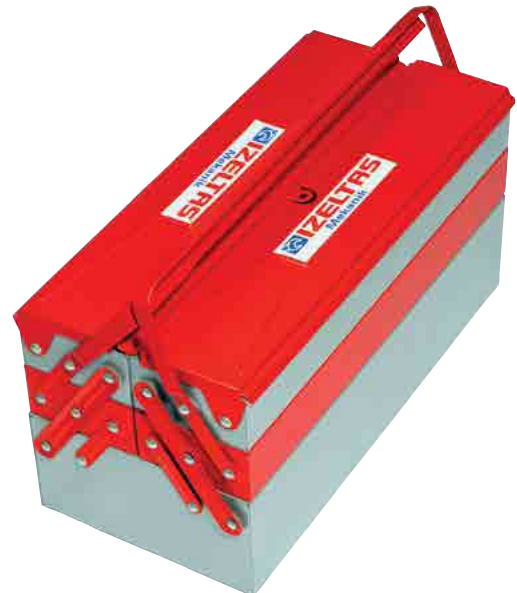

8420 00 5046
Elektrikçi Takım Çantası (5 Gözlü)
Tool Box (5 Trays)

Sacdan imal edilmiş, Fırın boya
 Made from metal sheet, Electrostatic paint

KOD CODE	ÖLÇÜ SIZE mm	g	TL/Ad.
8420 00 5046	190x420x200 DOLU / FULL	46	1157,90



KOD CODE	İÇERİK CONTENTS	
05881 50 005	PLASTİK ŞERİT METRE Plastic Steel Measuring Tape 5m	1
4782 19 6120	İZOLELİ BITS TUTUCU/Screwdriver,Magnetic Bit Holder Insulated 6,3x120	1
4800 00 8106	6 'LI BITS TAKIM/In Set(6 Pcs)	1
0600 01 1010	KURBAĞACIK/ Adjustable Jaw Wrench,PVC Coated 10"	1
4101	DÜZ SÜNGÜSÜ İZOLELİ TORNAVİDA Screwdriver,Electrician,Blade Insulated,Slotted 4x100-5,5x125-4,5x80-6x100	4
4550 17 0135	KONTROL KALEMİ/ Voltage Tester 135	1
4550 17 0190	KONTROL KALEMİ/ Voltage Tester 190	1
4772 19 0060	İZOLELİ LOKMA UÇLU TORNAVİDA Nut Spinner,Electrician Blode Insulated 6-7-8-10-13	5
0340	CIRCİR KOMBİNE Combination Wrench With Ratchet 8-10-12-13-17-19mm	6
4900 00 3110	10 'LU İZELTAŞ ALLEN ANAHTAR Hex Key Wrench Set 10 pcs	1
4500	KLEMENS DÜZ TORNAVİDA Screwdriver, Electronic, Slotted 3x80-3x100-3x125-3x60-4x80	5
3750 12 1160	KABLO SIYIRMA PENSE Wire Stripper 160 mm	1
3700 16 4160	160 mm ROD İZOLE YAN KESKİ Side Cutting Nippers,Rod insulated	1
3020 12 4180	ROD İZOLE KOMBİNE PENSE Combination Pliers,Rod Insulated 180 mm	1
3220 13 4160	ROD İZOLE UZUN DÜZ KARGABURUN Long Nose Pliers,Flat,Rod 160 mm	1



Tesisatçı Takım Çantası (5 Gözlü)
Tool Box (5 Trays)

Sacdan imal edilmiş, Fırın boyalı
 Made from metal sheet, Electrostatic paint

KOD CODE	ÖLÇÜ SIZE mm	g	TL/Ad.
8420 00 5028	190x420x200 DOLU / FULL	28	939,59



KOD CODE	İÇERİK CONTENTS	
0600 01 1010	10" KURBAĞACIK 10" Adjustable Jaw Wrench,PVC Coated	1
0600 01 1012	12" KURBAĞACIK 12" Adjustable Jaw Wrench,PVC Coated	1
2400 11 0240	240 ÜNİVERSAL FORT PENSE 240 Waterpump Pliers,Universal	1
2100 10 0012	12" STİLSON BORU ANAHTARI 12" Pipe Wrench,Stilson	1
4901 22 1270	1/2" SAE ALLEN ANAHTAR 1/2"Hex Key Wrench SAE	1
4300 17 6150	ROD DÜZ TORNAVİDA Screwdriver, Rod, Slotted 6x150 mm	1
4320 18 6100	ROD YILDIZ TORNAVİDA Screwdriver, Rod, Phillips 6x100 mm	1
5800 25 0500	ÇEKİÇ/ Machinist's Hammer 500 GR	1
5500 23 0200	BETON KESKİ/ Flat Cold Chisel 200 mm	1
3830 15 0250	BETONCU KERPETENİ/ Tower Pincers,PVC Coated 250 mm	1
4900 00 3112	12 'Lİ ALLEN TAKIM Hex Key Wrench Set 12 pcs	1
0588 15 0015	KROM ŞERİT METRE Chrom Case Steel Measuring Tape 5M	1
2201 10 0010	1" MAŞALI BORU ANAHTARI 1" Pipe Wrench	1
3700 16 2160	OPAK İZOLE YAN KESKİ Side Cutting Nippers,Opaque insulated 160 mm	1
3020 12 2180	OPAK İZOLE KOMBİNE PENSE Combination Pliers,Opaque Insulated 180 mm	1
3220 13 2160	OPAK İZOLE UZUN DÜZ KARGABURUN Long Nose Pliers,Flat,Opaque 160 mm	1



0600

Kurbağacık Anahtar Sehpası Adjustable Wrench



KOD CODE	İÇERİK CONTENTS	g	TL/Ad.
0600 31 6129	BOŞ - EMPTY	1800	1 80,50

7010

Çektirme Sehpası Display Frame For Puller



KOD CODE	İÇERİK CONTENTS	g	TL/Ad.
7010 31 6105	Boş - Empty	2000	1 55,62

1113

1/2" Lokma Anahtar Sehpası Display Frame for Sockets



KOD CODE	ÖLÇÜ SIZE mm	g	TL/Ad.
1113 31 6100	175x360x605	5800	1 126,81

1/2"

2350

Demir Kesme Makası Sehpası Bolt Cutters Frame



KOD CODE	İÇERİK CONTENTS	g	TL/Ad.
2350 31 6104	Boş	7400	1 172,70

7300

İşkence Sehpası Display For Screw Clamp



KOD CODE	İÇERİK CONTENTS	g	TL/Ad.
7300 31 6150	100x520x1420	8000	1 288,19

8001 - 8002

Çatal ve Yıldız Anahtar Sehpası Display Frame For Wrenches



Sacdan imal edilmiş, Fırın boyalı
Made from metal sheet, Electrostatic paint

KOD CODE	ÖLÇÜ SIZE mm	g	İÇERİK CONTENTS	TL/Ad.
8001 31 6012	160x500	800	Çatal / Open Jaw	1 37,31
8002 31 6012	170x560	1000	Yıldız / Ring	1 46,54

8003

Tornavida Sehpası
Display Frame for Screwdrivers



KOD CODE	ÖLÇÜ SIZE mm	g	TL/Ad.
8003 31 6070	250x490x550	5800	1 106,84

8004

Dövme Çelik Mengene Sehpası
Forged Steel Vice Frame



KOD CODE	İÇERİK CONTENTS	g	TL/Ad.
8004 31 6004	Boş	8000	1 357,35

8008

Mini Pano
Mini Frame



Sacdan imal edilmiş, Fırın boya
Made from metal sheet, Electrostatic paint

KOD CODE	ÖLÇÜ SIZE mm	g	TL/Ad.
8008 31 6001	505x710	5800	1 184,12

8015

Tekerlekli Üçgen Teşhir Standı
Triangular Display Frame



Sacdan imal edilmiş, Fırın boya
Made from metal sheet, Electrostatic paint

KOD CODE	ÖLÇÜ SIZE mm	g	TL/Ad.
8015 31 6001	520x1670	29500	1 506,77

8016

Tekerlekli Teşhir Panosu
Display Frame With Wheels



Sacdan imal edilmiş, Fırın boya
Made from metal sheet, Electrostatic paint

KOD CODE	ÖLÇÜ SIZE mm	g	TL/Ad.
8016 31 6001	520x710x1750	18200	1 396,13

8430

Pro - Plastik Takım Çantaları Plastic Tool Boxes



KOD CODE	ÖLÇÜ SIZE mm	g	TL/Ad.
8430 33 1601	410x210x200	1230	4 109,45
8430 33 1901	480x240x240	1790	4 140,80
8430 33 2301	580x270x280	2290	4 175,18

8500

Servis Masası (Panolu) Work Bench With Panel



Çelik Konstrüksiyon ve zor koşullarda çalışmaya elverişli
Özel Plywood ahşap tezgah
Strong and durable steel construction and
Plywood bench

KOD CODE	ÖLÇÜ SIZE mm	g	TL/Ad.
8500 34 6001	730x1470x1700	102800	1 2707,94

8501

Servis Masası (Panosuz) Work Bench (Without Panel)



Çelik konstrüksiyon ve zor koşullarda çalışmaya elverişli
Özel Plywood ahşap tezgah
Strong and durable steel construction and Plywood bench

KOD CODE	ÖLÇÜ SIZE mm	g	TL/Ad.
8501 34 6001	730x870x1700	84200	1 1811,44

8505

Usta Sandalyesi Master Chair



Çelik konstrüksiyon
Steel construction

KOD CODE	ÖLÇÜ SIZE mm	g	TL/Ad.
8505 34 6201	550x360x910	7000	1 244,82

8550

Servis Arabası Tool Trolley



Çelik konstrüksiyon
Steel construction

KOD CODE	ÖLÇÜ SIZE mm	g	TL/Ad.
8550 34 6001	500x850x960	50000	1 572,57



8705 00 6113

Hobby Set Oto Tipi (13 Parça)
Hobby Set Auto Type(13 pcs)



KOD CODE	İÇERİK CONTENTS	☐	TL/Ad.
0100 00 2106	8x9 - 10x11 12x13 - 14x15 16x17 - 18x19	6	276,03
1841 07 0021	21 mm	1	
2400 11 0240	240 mm	1	
3020 12 2160	160 mm	1	
4240 00 7102	4.5x80 - 6x80	1	
5800 25 0200	200 gr	1	
6350 26 0400	400 mm	1	

8710 00 4115

Poşet Oto Tipi (15 Parça)
Plastic bag For Auto (15 pcs)



KOD CODE	İÇERİK CONTENTS	☐	TL/Ad.
0130 00 2106	6x7 - 8x9 - 10x11 12x13 - 14x15 - 16x17	6	363,96
1841 07 0021	21 mm	1	
1975 09 1719	17x19 - 21x22	1	
2400 11 0240	240 mm	1	
3020 12 2180	180 mm	1	
4240 00 7102	4.5x80 - 6x80	1	
5500 23 0175	175 mm	1	
5800 25 0200	200 gr	1	
6350 26 0300	300 mm	1	

8715 00 4114

Poşet Oto Tipi (14 Parça)
Plastic bag For Auto (14 pcs)



KOD CODE	İÇERİK CONTENTS	☐	TL/Ad.
0130 00 2106	6x7 - 8x9 - 10x11 12x13 - 14x15 - 16x17	6	309,73
1841 07 0021	21 mm	1	
2400 11 0240	240 mm	1	
3020 12 2180	180 mm	1	
4240 00 7102	4.5x80 - 6x80	1	
5500 23 0175	175 mm	1	
5800 25 0200	200 gr	1	
6350 26 0300	300 mm	1	

8720 00 4110

Poşet Oto Tipi (10 Parça)
Plastic bag For Auto (10 pcs)



KOD CODE	İÇERİK CONTENTS	☐	TL/Ad.
0130 00 2106	6x7 - 8x9 - 10x11 12x13 - 14x15 - 16x17	6	164,88
1841 07 0021	21 mm	1	
3020 12 2180	180 mm	1	
4240 00 7102	4.5x80 - 6x80	1	

8725 00 3111

Poşet Oto Tipi (11 Parça)
Plastic bag For Auto (11 pcs)



KOD CODE	İÇERİK CONTENTS	☐	TL/Ad.
0100 00 2106	6x7 - 8x9 - 10x11 12x13 - 14x15 - 16x17	6	155,14
1841 07 0021	21 mm	1	
3020 12 2160	160 mm	1	
4100 17 4100	4x100	1	
4100 17 6100	6x100	1	
4120 18 4580	4.5x80	1	

8750 00 4117

Poşet Ev Tipi (17 Parça)
Plastic bag For Home (17 pcs)



KOD CODE	İÇERİK CONTENTS	☐	TL/Ad.
0130 00 2108	6x7 - 8x9 - 10x11 12x13 - 14x15 - 16x17 18x19 - 20x22	8	376,06
2400 11 0240	240 mm	1	
3020 12 2180	180 mm	1	
3800 15 0160	160 mm	1	
4100 17 0480	4x80	1	
4100 17 5125	5x125	1	
4120 18 0360	3x60	1	
5010 23 0014	14 mm	1	
5500 23 0125	125 mm	1	
5800 25 0200	200 gr	1	

8755 00 6107

Hobby Set Ev Tipi (7 Parça)
Hobby Set For Home (7 pcs)



KOD CODE	İÇERİK CONTENTS	☐	TL/Ad.
2400 11 0240	240 mm	1	271,27
3020 12 2160	160 mm	1	
3220 13 2160	160 mm	1	
3700 16 2140	140mm	1	
4240 17 0680	6x80 mm	1	
4550 17 0135	135mm	1	
5800 25 0200	200 gr	1	

8760 00 3105

Poşet Ev Tipi (5 Parça)
Plastic bag For Home (5 pcs)



KOD CODE	İÇERİK CONTENTS	☐	TL/Ad.
0600 01 1010	10" (250 mm)	1	183,19
3020 12 2180	180 mm	1	
4100 17 6125	6x125	1	
4120 18 4580	4.5x80	1	
5800 25 0200	200 gr	1	

8770 00 3104

Poşet Ev Tipi (4 Parça)
Plastic bag For Home (4 pcs)



KOD CODE	İÇERİK CONTENTS	□	TL/Ad.
3020 12 2160	160 mm	1	120,51
3800 15 0160	160 mm	1	
4100 17 6100	6x100	1	
5800 25 0100	100 gr	1	

8771 00 3103

Poşet Ev Tipi (3 Parça)
Plastic bag For Home (3 pcs)



KOD CODE	İÇERİK CONTENTS	□	TL/Ad.
3020 12 2160	160 mm	1	80,44
4100 17 6100	6x100	1	
5800 25 0100	100 gr	1	

8780 00 3105

Elektrikçi Tipi Poşet (5 Parça)
Plastic bag For Electrician (5 Pcs)



KOD CODE	İÇERİK CONTENTS	□	TL/Ad.
3220 13 2160	160 mm	1	164,48
3700 16 2160	160 mm	1	
4100 17 4100	4x100	1	
5500 23 0125	125 mm	1	
5800 25 0100	100 gr	1	

8785 00 8106

Elektronikçi Set (6 Parça)
Electronic Set (6 Pcs)



KOD CODE	İÇERİK CONTENTS	□	TL/Ad.
3550 14 0125	125 mm	1	149,12
3553 14 0150	150 mm	1	
4500 17 3100	3x100	1	
4500 17 4150	4x150	1	
4520 18 0360	3x60	1	
4520 18 4150	4x150	1	



8776 00 8706

Servis Seti (6 Parça)
Maintenance Kit(6 Pcs)



KOD CODE	İÇERİK CONTENTS	☐	TL/Ad.
3020 12 4160	160 mm	1	197,27
3220 13 4160	160 mm	1	
3700 16 4140	140 mm	1	
4300 17 5100	5x100	1	
4320 18 4580	4.5x80	1	
3013 56 4130	Açacak / Battle Opener	1	

8790 00 8106

Bakım Onarım Seti (6 Parça)
Maintenance Kit(6 Pcs)



KOD CODE	İÇERİK CONTENTS	☐	TL/Ad.
3020 12 5160	160 mm	1	217,04
3220 13 5160	160 mm	1	
3700 16 5140	140 mm	1	
4350 17 5100	5x100	1	
4370 18 4580	4.5x80	1	
05870 50 001	LED Lamba / LED Pen Torch	1	

8006 00 6025

Opak Pense Serisi
Opaque Pliers Set



KOD CODE	İÇERİK CONTENTS	☐	TL/Ad.
3020 12 2160	160 mm	5	1331,75
3020 12 2180	180 mm	5	
3220 13 2160	160 mm	5	
3700 16 2140	140 mm	5	
3700 16 2160	160 mm	5	



Marina Set (38 Parça)
Marine Set (38 Pcs)

Sarı Çinko kaplı
Yellow Zinc plated

KOD CODE	İÇERİK CONTENTS	URUN / PRODUCT	TL/Ad.
0370 02 9007	7 mm	Kombine Anahtar (Boyunlu) Offset Combination Wrench	
0370 02 9008	8 mm		
0370 02 9010	10 mm		
0370 02 9011	11 mm		
0370 02 9012	12 mm		
0370 02 9013	13 mm		
0370 02 9014	14 mm		
0370 02 9015	15 mm		
0370 02 9016	16 mm		
0370 02 9017	17 mm		
0370 02 9019	19 mm		
2400 11 9240	240 mm	Üniversal Fort Pense Water Pump Plier	
3020 12 9180	180 mm	Kombine Pense Combination Pliers	
3700 16 9160	160 mm	Yan Keski Side Cutter	
3220 13 9160	160 mm	Kargaburun Düz Uçlu Long Nose Pliers Flat	
0600 01 9008	8"	Kurbağacık Anahtar Adjustable Wrench	
4300 17 9480	4x80	Rod Düz Uçlu Tornavida Flat Screwdriver	
4300 17 9610	6x100	Flat Screwdriver	
4320 18 9458	4.5x80	Rod Yıldız Uçlu Tornavida Phillips Screwdriver	
4320 18 9610	6x100	Phillips Screwdriver	
4900 22 9020	2	Allen Anahtar Altı Köşe Hex Key Wrench	872,31
4900 22 9025	2.5		
4900 22 9030	3		
4900 22 9040	4		
4900 22 9050	5		
4900 22 9060	6		
4900 22 9070	7		
4900 22 9080	8		
4900 22 9090	9		
4900 22 9100	10		
5500 23 9150	150	Düz Keski Flat Cold Chisel Chromium	
5550 24 9004	4mm	Düz Pim Zimba Split Pin Punch	
5800 25 9300	300 gr	Tesviyeci Çekiç Hammer	
1841 07 9021	21 mm	Kovan Anahtar Bir Ağız Tubular Socket Wrench with Handle Bar	
1850 07 9120	10x120	Kovan Anahtar Mili Tommy Bar	
05901 50 020	0.05 - 1 mm	Sentil Feeler Gauge	
2500 11 9250	250 mm	Üniversal Ayarlı Pense Universal Grip	
6350 26 9400	400 mm	Oluklu Levye Tyre Lever - Chromium	

**DENİZ SUYUNA ve RUTUBETE
KARŞI ÖZEL KORUMALI**

Suya dayanıklı Marine tip el aletleri

Su sporlarıyla uğraşan tüm amatör ve profesyoneller; yat ve tekne sahipleri için İZELTAŞ suya dayanıklı özel marine tip el aletleri üreterek denizcilik sektörüne hizmet veriyor.

Aletlerin sahip olduğu özel yüzey kaplama, denizdeki hava şartlarından ve deniz suyunun verebileceği zararlardan aletleri korur.

Kapaktaki su geçirmez conta ise, kutu içine suyun ve rutubetin girmesini engelliyerek, korozyon oluşmasını önler.

Deniz suyunun ne kadar zarar verici olduğunu sizlerde tecrübelerinizle bilmektesiniz. Bu nedenle İZELTAŞ, size marine aletler ile rutin bakım çalışmalarınızı aksatmadan ve bir problemle karşılaşmadan yapmanızı sağlar.

Aletler, bakım çalışmasından sonra mutlaka temizlenmeli ve iyice kurulanıp, koruyucu yağ ile yağlandıktan sonra yerlerine konarak, kutunun sıkıca kapatılması gerekmektedir. İZELTAŞ marine setler, standart İzeltaş garantisi altındadır. Ancak doğru kullanılmamaktan dolayı olabilecek kırılma ve hasarlar garanti kapsamı dışındadır.

**DENİZ SUYUNA VE
RUTUBETE KARŞI
ÖZEL KORUMALI**



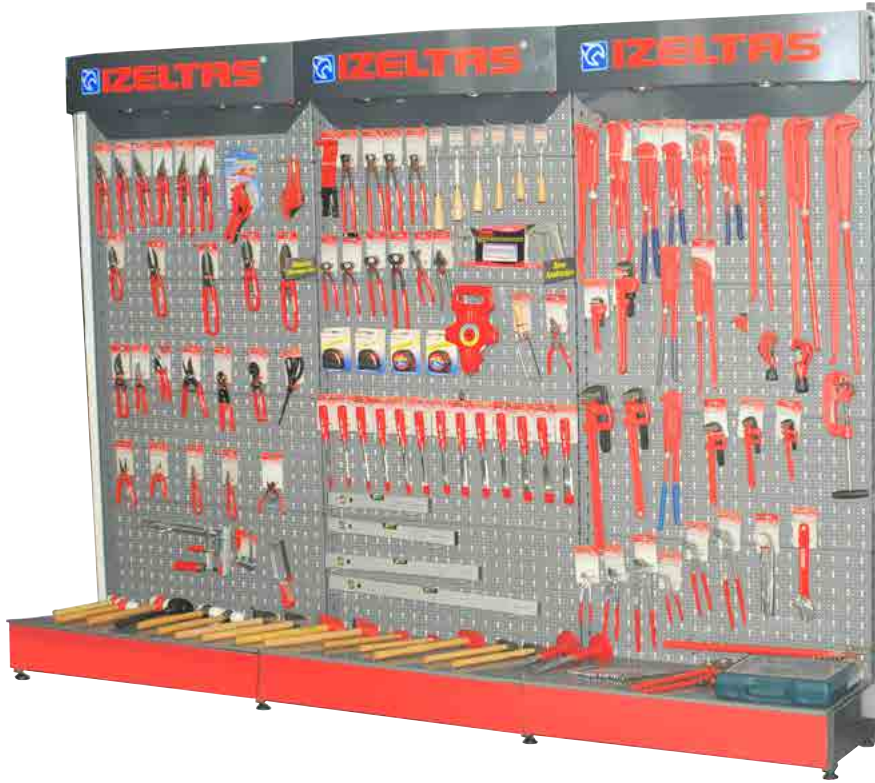

İzeltaş El Aletleri Teşhir Panosu, satış noktaları için özel olarak dizayn edilmiştir. Kolayca monte edilebilen 17 ana parçadan oluşan panonun derinliği 50 cm, genişliği 100 cm, yüksekliği 225 cm'dir. Etkili görünümü ve tüm ürünleri bir arada sergileme özelliği yanında, perakende satışlarda seçme kolaylığı sağlaması bakımından da önem taşımaktadır.

İzeltaş's Product Exhibition Board have been specially designed for selling points. These boards have been formed from easily mountable 17 main parts and dimensions are, width 50 cm, length 100 cm and height 225 cm. Feature of boards impressive good looking and showing of all products together which is very important in easily choosing the desired tools from boards in retail selling activities.

Board features an impressive looking and displays the products all together, which makes it easy to choose desired tools in retail selling activities.

Büyük Pano Display Panels (full)

Montaj Sırası / Montage Order

1. Ayak / Stand right leg
2. Plastik ayak / Plastic leg
3. Kolon / Stand right column
4. Ayak / Stand left leg
5. Plastik ayak / Plastic leg
6. Kolon / Stand left column
7. Rafl / Shelf
8. Delikli pano / Drilled panel
9. Delikli pano / Drilled panel
10. Delikli pano / Drilled panel
11. Delikli pano / Drilled panel
12. Yarım delikli pano / Half - drilled panel
13. Aydınlatma alınlığı / Illumination panel
14. Yan kapak / Side cover
15. Yan kapak / Side cover
16. Ön kapak / Front cover
17. Tornavida askısı / Screwdriver hanger
18. Büyük askı / Long hanger
19. Küçük askı / Short hanger

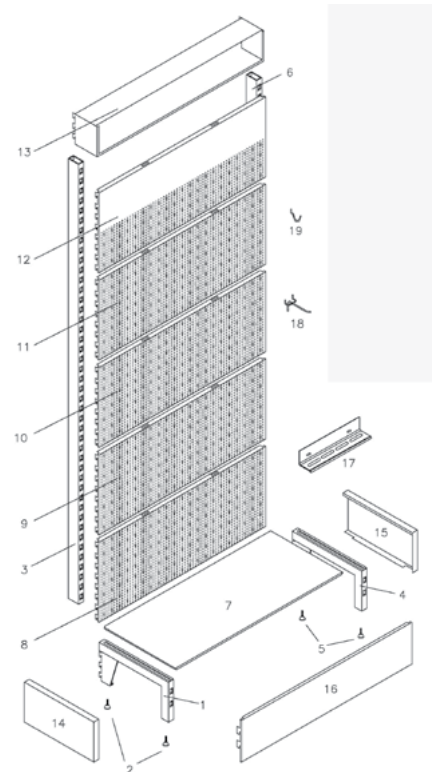

KOD CODE	SIZE mm	Cinsi	g	TL/Ad.
8010 31 6001	460x1000x2200	Boş	43000	1 757,46

5 GÖZLÜ TAKIM ÇANTASI DOLU

METAL TOOL BOX 5 TRAYS FULL

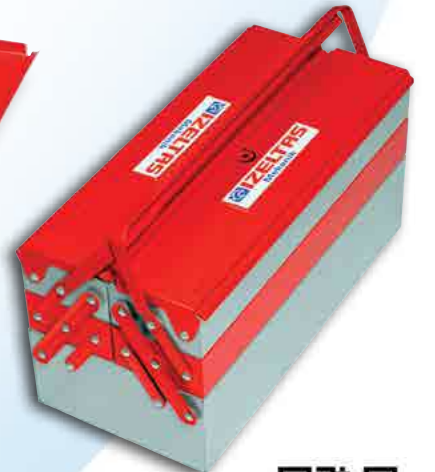

**TESİSATÇI
FOR PLUMBER**

**ELEKTRİKÇİ
FOR ELECTRICIAN**

**MEKANİK
FOR MECHANICIAN**

IZELTAS®

www.izeltas.com.tr



Teknik Bilgiler

Technical Informations

0-
Squ

0-
Kovan Anahtar
Tubular Socket W

00 Bir Ağız Bijon Anahtar
Single Ended Rim Wrench

TORX[®] Lokma Anahtar
TORX Socket

Düz Uç
Flat Tip

Yıldız Uç
PHILLIPS Tip

Çektirici
Puller

İşin türüne göre
Use necessary p
specification of the

Sıkma ve sökme işlemleri daima çekerek yapılmalıdır.
Tightening and extracting applications must be done as pulling.

Esit sertlikteki parçaların bir arada kullanılması için çapların yaklaşık 10 mm'ye kadar farklı olması gerekir. Çekiş kuvveti geniş olmasına özen gösterilmelidir. Arızalı, gevşek veya çatlak aletler kullanılmamalıdır.

Doğru duruşla, doğru hareketi yapın ve uygun olan aleti kullanın.
Make sure that you are well balanced, doing the right motion and use the suitable tools.

Never hit on equal or hand tools. Have a diameter approx. 10 mm to hit. Do not use loose, cracked or

Tork anahtarları ile birlikte asla uzatma kullanmayın. Doğru ölçümler için daima sap yerinden tutunuz. Kapasitesinin üzerinde yük uygulamayınız.

Do not use any extension with the torque meters. Always grasp from the handle. Do not overload by applying torque exceeds rated capacity.

Güvenlik Uyarıları/Safety Recommendations**Risk almayın, tedbir alın**

İzeltaş El Aletleri, işinizi daha da kolaylaştırmak için her zaman yanınızda olan, özel olarak tasarlanmış en iyi iş arkadaşlarınız. Gelin, onları iş güvenliği kurallarına uyarak, alınacak tedbirleri ihmal etmeyerek kullanalım, sağlığımızı tehlikeye atmayalım.

Don't take risk, just take the necessary measures

İzeltaş Hand Tools are your best work-friends, specially designed for facilitating your job. Let us use them within taking care of the necessary rules, and do not endanger our lives.



Elektrikle bağlantılı işlerde çalışırken mutlaka VDE 1000V aletlerini kullanınız. Diğer plastik saplar izolasyon amaçlı tasarlanmamıştır.

Use VDE 1000 V tools only while you are working with live components. Other plastic handles of the tools are not designed to insulate.



İşin türüne göre gereken koruyucuları kullanınız.

Use necessary protection materials according to the specification of the job.



Sıkma ve sökme işlemi daima çekerek yapılmalı.

Tightening and extracting applications must be always do as pulling.



Doğru duruşla, doğru hareketi yapın ve uygun olan aleti kullanın.

Make sure that you are well balanced, doing the right motion and use the suitable tools.

GÜVENLİK UYARILARI / Safety Recommendations

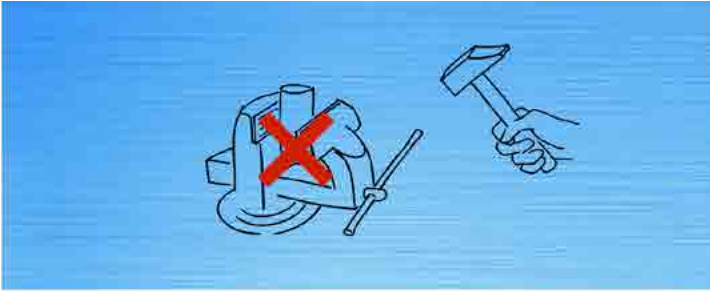

Mengene, işkence türü aletlerin sıkma işleminde çekiç ve uzatma kolu kullanmayınız.

Do not use hammer and extension bar while using kinds of clamping tools.

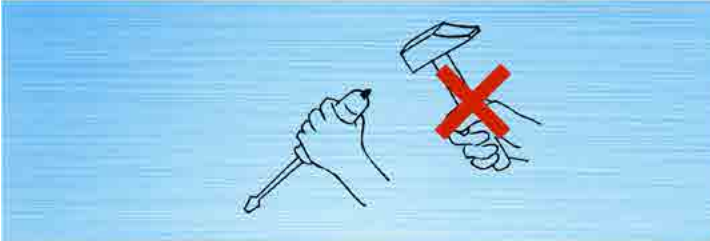

Tornavidanızı keski, punta veya levye yerine kesinlikle kullanmayınız.

Do not use a screwdriver as a chisel or lever.

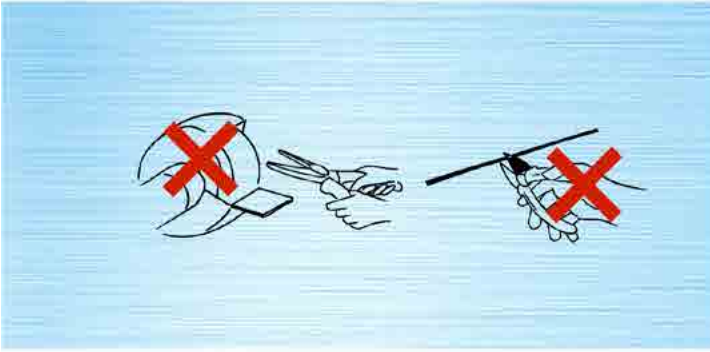

Kesme için uç yerine mafsala yakın yeri kullanınız. Somun ve civata üzerinde kullanmayınız. Çekiç gibi kullanmayınız. Ayarlı (kilitlenebilir) penseleri uzun süre kilitli bırakmayınız, asla basamak gibi kullanmayınız, elemanlar oynayabilir. Asla orijinali bozmayınız.

Use the throat rather than tip of cutting edge. Do not use for bolts and nuts. Do not use like a hammer. Grip pliers should not be used as a permanent clamp, parts can move. Do not modify products.

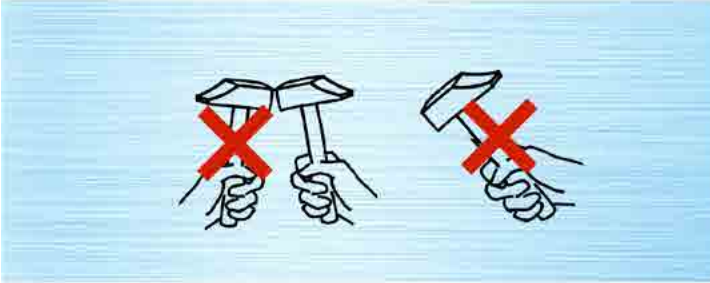

Eşit sertlikteki veya daha sert yüzeylere çekiçle vurmaktan sakınınız. Çekiğin çarpma yüzeyinin vurulan alandan geniş olmasına özen gösteriniz (Çekiç kafasının çapı vurulan yüzeyden yaklaşık 10 mm daha geniş olmalıdır). Arızalı, gevşek veya çatlak çekiçleri kesinlikle kullanmayınız.

Never hit on equal or harders surfaces. A hammer should have a diameter approx. 10 mm larger than the surface to hit. Do not use loose, cracked head hammers.

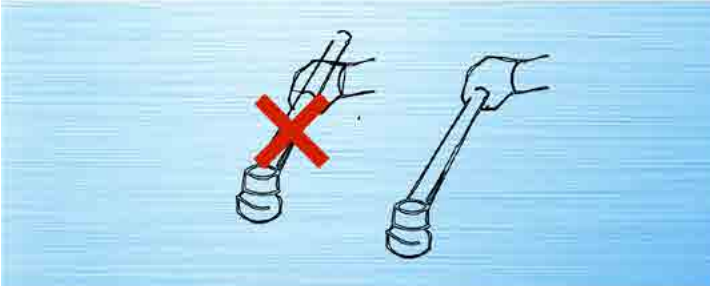

Tork anahtarı ile birlikte asla uzatma kullanmayınız. Doğru ölçümler için daima sap yerinden tutunuz. Kapasitesinin üzerinde yük uygulamayınız.

Do not use any extension with the torquemeters. Always grasp from the handle. Do not overload by applying torque exceeds rated capacity.

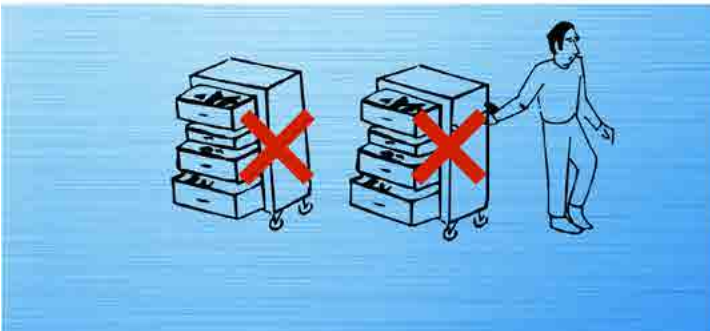

Sabit kullanımda birden fazla çekmece açmayınız. Hareket halinde bütün çekmeceler ve kapılar kapalı olmalı ve üzerinde bir şey bulunmamalıdır.

Do not open more than one drawer during your usage. While moving all drawers, doors must be locked.

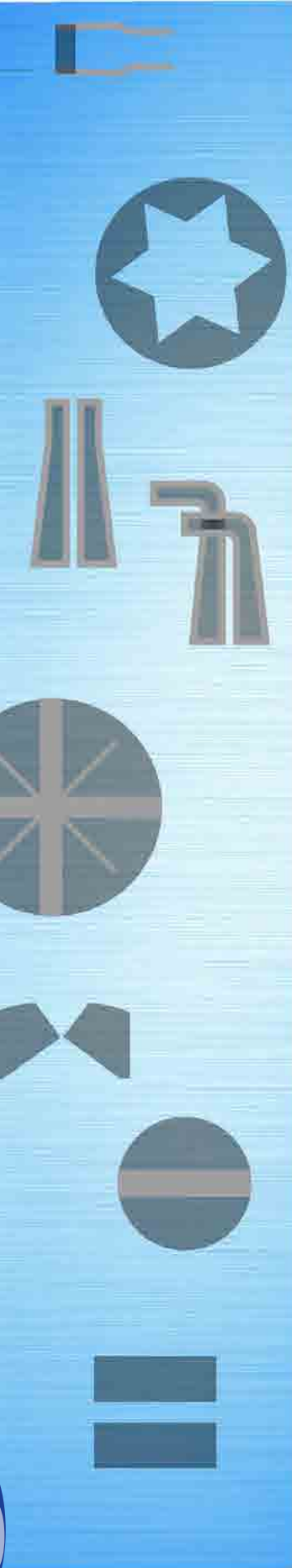
Semboller / Symbols

Anahtar Ağız
Size



Ağız Açıklığı
Opening Limit of Jaws



Altı Köşe Lokma Bijon
Anahtar Ağız
Six Point Sockets



Sekiz Köşe Anahtar Ağız
Eight Point Wrench



On iki Köşe Anahtar Ağız
Twelve Point Wrench



Kare Adaptör
Square Adapter



Kovan Anahtar
Tubular Socket Wrench



Bir Ağız Bijon Anahtar
Single Ended Rim Wrench



TORX® Lokma Anahtar
TORX® Socket



Düz Uç
Flat Tip



Yıldız Uç
PHILLIPS® Tip



POZIDRIV® Yıldız Uç
POZIDRIV® Tip



TORX® Uç
TORX® Tip



Delikli TORX® Uç
TORX® with hole



Bits Tutucular
Bit Holders



Allen Anahtar
Hexagonal Allen Keys



Segman
Circlip



Gövde Ağırlık
Weight of Body



Tapa Anahtar
Wrench for Carter Case



İşkençe
Screw Clamp



Çektirme
Puller

TEKNİK BİLGİLER / Technical Information

Uzunluk / Length	cm	m	km	inç(in)	ayak(ft)	yarda	kara mili	deniz mili
1 santimetre (cm)	1	0.01	-	0.3937	0.0328	-	-	-
1 metre (m)	100	1	0.001	39.37	3.281	1.094	-	-
1 kilometre (km)	100.000	1000	1	39370	3281	1094	0.6214	0.5396
1 inç (in.) inch	2.540	0.0254	-	1	0.833	0.0278	-	-
1 ayak (foot) ft	30.48	0.3048	-	12	1	0.3333	-	-
1 yarda(yard.)	91.44	0.9144	-	36	3	1	-	-
1 kara mili(statute mile)	-	1609	1.609	63360	5280	1760	1	0.8684
1 deniz mili	-	1852	1.852	72960	6080	2027	1.152	1

Alan / Area	cm ²	m ²	a	ha ²	km ²	in ²	ft ²	yard ²	mil ²	acre ²
1 Santimetre kare (cm ²)	1	0.0001	-	-	-	0.155	-	-	-	-
1 Metre Kare (m ²)	10.000	1	0.01	-	-	1550	10.76	1.196	-	-
1 ar (a)	-	100	1	0.01	-	-	1076	119.6	-	0.0247
1 hektar (ha)	-	10000	100	1	0.01	-	-	0.0039	2.47	-
1 kilometre kare (km ²)	-	-	10000	100	1	-	-	-	0.3861	247.1
1 inç kare(inch square)	6.452	-	-	-	-	1	-	-	-	-
1 ayak kare (ft ²)										
(foot square)	929	0.0929	-	-	-	144	1	0.11	-	-
1 yarda kare (square yard)	8361	0.8361	-	-	-	1296	9	1	-	-
1 mil kare (square mile)	-	-	-	259	2.59	-	-	-	1	640
1 acre	-	4050	40.5	0.405	-	-	43640	4850	0.0016	1

Ağırlık / Weight	gr	kg	metrik ton	ounce	libre pound	stone	küç.ton	büy.ton
1 gram (gr)	1	0.001	-	0.332	-	-	-	-
1 kilogram (kg)	1000	1	0.001	35.27	2.205	0.157	0.0011	0.00098
1 ton (metrik)	-	1000	1	35274	2204.6	157.47	1.1023	0.9842
1 ounce (oz)	28.35	0.028	-	1	0.0625	0.004	-	-
1 libre (lb) (pound)	453.6	0.454	-	16	1	0.071	-	-
1 stone	6350	6.35	0.0064	224	14	1	0.007	0.0063
1 küçük ton (short ton)	907.190	907.2	0.907	32000	2000	142.9	1	08929
1 büyük ton (long ton)	1106050	1016	1.016	35840	2240	160	1.120	1

Hacim / Volume	cm ³	dm ³ Litre	in ³	ft ³	ABD yard ³ yard ³	ing ounce	ABD ounce	ing galon	ing galon	ing pint
1 Santimetre küp (cm ³)	1	0.001	0.061	-	-	0.038	0.353	-	-	-
1 desimetre küp (m ³)	1000	1	61.02	0.035	-	33.81	35.3	0.2642	0.22	1.76
1 inç küp (in ³)	16.39	0.0164	1	-	-	0.5541	0.5768	-	-	0.0288
1 ayak küp (cubic foot) ft ³		28.32	1728	1	0.0370	957.5	966.6	7.481	6.232	49.83
1 yarda küp		764.6	46656	27	1	25853	26906	202	168.2	1345
1 ounce (ABD)	29.57	0.02296	1.805	-	-	1	1.041	-	-	0.0520
1 ounce (ing)	28.41	0.0284	1.734	-	-	0.9607	1	-	-	0.05
1 galon (ABD)	3785	3.785	231	0.1337	-	128	133.2	1	0.8327	6.662
1galon (ing)	4546	4.546	277.4	0.1603	-	153.7	160	1.201	1	8
1 pint	568.2	0.5682	34.68	0.02	-	1921	20	0.1501	0.125	1

Ölçü Birimleri Measuring Units

Giga	G	1.000.000.000	=10 ⁹	1GW= 1 Milyar Watt
Mega	M	1.000.000	=10 ⁶	1 MW= 1 Milyon Watt
Kilo	k	1.000	=10 ³	1 kW= Bin Watt
Milli	m	0.001	=10 ⁻³	1 mm= Binde Bir Watt
Mikro	μ	0.000001	=10 ⁻⁶	1 mm= 1 Milyonda Bir Watt
Nano	n	0.000000001	=10 ⁻⁹	1 nm= 1 Milyarda Bir Watt

Önemli Ölçülerin Değişim Tablosu Conversion Table For Essential Measuring Units

Uzunluk Length	Metre	m		
Kütle Weight	Kilogram	kg		
Zaman Time	Saniye	s		
Kuvvet Force	Newton	N	=kg m/s ²	1 N= 0,102 kp
Döndürme Mom. Torque	Newtonmetre			9.81 Nm= 1kpm
İş Enerjisi Work	Joule	J	=Nm	
Isı Enerjisi Heat	Joule	J		1 J= 0.239 cal
Güç Power	Watt	W	=Nm/s	1 kW= 1.36 PS=860 kcal/h
Basınç Pressure	Pascal	Pa	=N/m ²	100.000 Pa=1 bar=10 mWS
Elektrik Akımı Electricity Current	Amper	A		
Sıcaklık Temperature	Kelvin	K		1 K=1°C

Döndürme Momenti Dönüşüm Tablosu Conversion Table For Bending Moments

Var Olan Ölçüler/ present units	İstenen Ölçüler / Wanted Units					
	=Ncm	=Nm	=kpcm	=kpm	=lbf.in.	=lbf.ft.
Ncm	1	0.01	0.10197	0.00102	0.0885	0.00738
Nm	100	1	10.197	0.10197	8.851	0.7376
kpcm	9.807	0.09807	1	0.01	0.868	0.0723
kpm	980.07	9.807	100	1	86.796	7.233
lbf.in.	135.58	1.3558	13.825	0.13825	12	1

Newton-Metre ve Librefoot Dönüşüm Tablosu Conversion Table Of Newton-Meter And Librefoot (1 Nm=0.738 lbf.ft.)

Nm	ft.,lbs.									
	0	1	2	3	4	5	6	7	8	9
0	0	0.74	1.48	2.21	2.95	3.69	4.43	5.17	5.90	6.64
10	7.38	8.12	8.86	9.59	10.33	11.07	11.81	12.54	13.28	14.02
20	14.76	15.50	16.2	16.97	17.71	18.45	19.19	19.93	20.65	21.40
30	22.14	22.88	23.62	24.35	25.10	25.83	26.57	27.31	28.04	28.78
40	29.52	30.26	31.00	31.73	32.47	33.21	33.95	34.69	35.42	36.16
50	36.90	37.64	38.38	39.11	39.85	40.59	41.33	42.07	42.80	43.54
60	44.28	45.02	45.76	46.49	47.23	47.97	48.71	49.45	50.18	50.92
70	51.66	52.40	53.14	53.87	54.61	55.35	56.09	56.83	57.56	58.30
80	59.04	59.78	60.52	61.25	62.00	62.73	63.47	64.21	64.94	65.68
90	66.42	67.16	67.90	68.63	69.37	70.11	70.85	71.59	72.32	73.06
100	73.80	74.54	75.28	76.01	76.75	77.49	78.23	78.97	79.70	80.44

Librefoot ve Newton-Metre Dönüşüm Tablosu Conversion Table Of Librefoot And Newton-Meter (1 lbf.ft.=1.356 Nm)

ft.- lbs.	Nm									
	0	1	2	3	4	5	6	7	8	9
0	0	1.36	2.71	4.07	5.42	6.78	8.14	9.49	10.85	12.20
10	13.56	14.92	16.27	17.63	18.98	20.34	21.70	23.05	24.41	25.76
20	27.12	28.48	29.83	31.19	32.54	33.90	35.26	36.61	37.97	39.32
30	40.68	42.04	43.39	44.75	46.10	47.46	48.82	50.17	51.53	52.88
40	54.24	55.60	56.95	58.31	59.66	61.02	62.38	63.73	65.09	66.44
50	67.80	69.16	70.51	71.87	73.22	74.58	75.94	77.29	78.65	80.00
60	81.36	82.72	84.07	85.43	86.78	88.14	89.50	90.85	92.21	93.56
70	94.92	96.28	97.63	98.99	100.34	101.70	103.06	104.41	105.77	107.12
80	108.48	109.84	111.19	112.55	113.90	115.26	116.62	117.97	119.33	120.68
90	122.04	123.40	124.75	126.11	127.46	128.82	130.18	131.53	132.89	134.24
100	135.60	136.96	138.31	139.67	141.02	142.38	143.74	145.09	146.45	147.80

Newton-Metre ve Kilopound-Metre Dönüşüm Tablosu Conversion Table Of Newton-Meter and Kilopound-Meter (1 Nm=0.102 kpm)

Nm	kpm									
	0	1	2	3	4	5	6	7	8	9
0	0.00	1.02	2.04	3.06	4.08	5.10	6.12	7.14	8.16	9.18
100	10.20	11.22	12.24	13.26	14.28	15.30	16.31	17.33	18.35	19.37
200	20.39	21.41	22.43	23.45	24.47	25.49	26.51	27.53	28.55	29.57
300	30.59	31.61	32.63	33.65	34.67	35.69	36.71	37.73	38.75	39.77
400	40.79	41.81	42.83	43.85	44.87	45.89	46.91	47.93	48.95	49.97
500	50.99	52.00	53.02	54.04	55.06	56.08	57.10	58.12	59.14	60.16
600	61.18	62.20	63.22	64.24	65.26	66.28	67.30	68.32	69.34	70.36
700	71.38	72.40	73.42	74.44	75.46	76.48	77.50	78.52	79.54	80.56
800	81.58	82.60	83.62	84.64	85.66	86.68	87.70	88.71	89.73	90.75
900	91.77	92.79	93.81	94.83	95.85	96.87	97.89	98.91	99.93	100.95
1000	101.97	102.99	104.01	105.03	106.05	107.07	108.09	109.11	110.13	111.15

Sertlik Dönüşüm Tablosu
Hardness Conversion Table

Vickers Sertlik Hardness	Brinell Sertlik Hardness	Rockwell Sertlik Hardness		Çekme dayanımı Tensile Strength
HV 30	HB 30	HRB	HRC	sB N/mm ²
85	80.7	36.4	-	270
85	85	42.4	-	290
90	90	47.4	-	310
95	95	52.00	-	320
100	100	56.4	-	340
105	105	60.0	-	360
110	110	63.4	-	380
115	115	66.4	-	390
120	120	69.4	-	410
125	125	72.0	-	420
130	130	74.4	-	440
135	135	76.4	-	460
140	140	78.4	-	470
145	145	80.4	-	490
150	150	82.2	-	500
155	155	83.8	-	520
160	160	85.4	-	540
165	165	86.8	-	550
170	170	88.2	-	570
175	175	89.6	-	590
180	180	90.8	-	600
185	185	91.8	-	620
195	190	91.5	-	640
200	195	94.0	-	660
200	200	95.0	-	670
205	205	95.8	-	680
210	210	96.6	-	710
215	214	96.6	-	720
220	220	98.2	-	730
225	225	99.0	-	750
230	230	-	19.2	760
235	235	-	20.2	780
240	240	-	21.2	800
245	245	-	22.1	820
250	250	-	23.0	830
255	255	-	23.8	850
260	260	-	24.6	870
265	265	-	25.4	880
280	266	-	27.1	900
275	275	-	26.9	920
280	280	-	27.6	940
285	285	-	28.3	950
290	290	-	29.0	970
295	295	-	29.6	990
300	300	-	30.3	1010
310	310	-	31.5	1040
320	320	-	32.7	1080
330	330	-	33.8	1110

Vickers Sertlik Hardness	Brinell Sertlik Hardness	Rockwell Sertlik Hardness		Çekme dayanımı Tensile Strength
HV 30	HB 30	HRB	HRC	sB N/mm ²
340	340	-	34.9	1140
350	350	-	36.0	1170
360	359	-	37.0	1200
370	368	-	38.0	1260
380	376	-	38.9	1260
390	385	-	39.8	1290
400	392	-	40.7	1320
410	400	-	41.5	1350
420	408	-	42.4	1380
440	423	-	44.0	1430
450	430	-	44.8	1460
460	-	-	45.6	-
470	-	-	46.3	-
480	-	-	47.0	-
490	-	-	47.7	-
500	-	-	48.3	-
510	-	-	49.1	-
520	-	-	49.7	-
530	-	-	50.4	-
540	-	-	51.0	-
550	-	-	51.6	-
560	-	-	52.2	-
570	-	-	52.8	-
580	-	-	53.3	-
590	-	-	53.9	-
600	-	-	54.4	-
610	-	-	55.0	-
620	-	-	55.5	-
630	-	-	56.0	-
640	-	-	56.5	-
650	-	-	57.0	-
660	-	-	57.5	-
670	-	-	58.0	-
680	-	-	58.5	-
690	-	-	59.0	-
700	-	-	59.5	-
720	-	-	60.4	-
740	-	-	61.2	-
760	-	-	62.0	-
780	-	-	62.8	-
800	-	-	63.6	-
820	-	-	64.3	-
840	-	-	65.0	-
860	-	-	65.7	-
880	-	-	66.3	-
900	-	-	66.9	-
920	-	-	67.5	-
940	-	-	68.0	-



İZELTAŞ, yüksek kaliteli el aletleri üretimi yanı sıra modern tesislerinde muhtelif sektörlere sıcak dövme parça üretimi de yapmaktadır. CAD ortamında geliştirilen ve CNC'lerde üretilen kalıplarda dövülen yüksek vasıflı çelikten mamul sıcak dövme parçalar başta otomotiv olmak üzere, savunma sanayi, makine imalat sektörü ile inşaat ve ziraat endüstrilerinde kullanılmaktadır.

3000 kg'a kadar serbest düşümlü çekiçler ve 8000 kg'a kadar muhtelif hidrolik dövme tezgahlarında, 50 gr'dan 30 kg'a kadar dövülen parçalar, uluslararası dövme toleransı standartlarında üretilmektedir. Dövme prosesi sonrasında, müşteri isteklerine göre parçalara; kalibre, ısıtma işlemi veya çatlak kontrol gibi işlemler de uygulanmaktadır.

Sahip olduğu ISO 9001 ve ISO/TS 16949 kalite yönetim sistem belgeleri yanı sıra, 2009 yılında ISO 14001 Çevre Yönetim Sistem belgesi, OHSAS TS 18001 İş Sağlığı ve Güvenliği sistem belgesi ve ISO 50001 Enerji Yönetim Sistem belgesi alınmıştır.

Besides manufacturing high quality hand tools in its modern facilities, İZELTAŞ produces hot-forged parts for various industry sectors. Parts hot-forged from high grade steel are supplied to automotive, defense, machinery, construction, and agricultural industries. These parts are formed by die-tools, which are designed and manufactured by CAD software and CNC machinery.

Hot-forged parts, produced by free-falling hammers up to 3000kg and hydraulic hammers up to 8000kg, weigh from 50gr to 30kg and ensure forging dimension tolerances in accordance with the related international standards.

İZELTAŞ Quality Management System is certified with ISO 9001 and ISO/TS 16949. In 2009, İZELTAŞ also succeeded to acquire ISO 14001 Environmental Management System, OHSAS 18001 Occupational Health and Safety Management System and Energy Management System.

ALET İŞLER

EL ÖVÜNÜR



IZELTAS
İZMİR EL ALETLERİ SANAYİ VE TİCARET A.Ş.

Kemalpaşa Caddesi No: 303 Işıkkent İzmir - TÜRKİYE

İNTERNET ADRESİMİZ /WEB

www.izeltas.com.tr info@izeltas.com.tr

SİPARİŞ TEL / PHONE FOR ORDERS

Direkt: +90.232 472 13 92

Santral Tel: +90.232 472 13 75

Fax: +90.232 472 13 78

ANKARA İRTİBAT BÜROMUZ:

ANKARA OFFICE:

Alinteri Bulvarı

Alinteri Plaza 23 /3

OSTİM ANKARA

Tel: +90.312 385 24 83

385 24 28

Fax: +90.312 385 04 13

İSTANBUL İRTİBATBÜROMUZ:

İSTANBUL OFFICE:

Perpa Ticaret Merkezi

No.988 K.7 P.K:80270

Okmeydanı - İSTANBUL

Tel: +90.212 220 05 69

220 84 04 - 221 74 50

Fax: +90.212 221 74 51